







Code d'assemblage	Description de l'assemblage	Image d'assemblage
ASM2912A/0.D02	Chambre de cuisson	
ASM2917A/0.D01	Couverture extérieure	
ASM2922A/0.D02	Porte	
ASM2926A/0.D02	Système électrique	



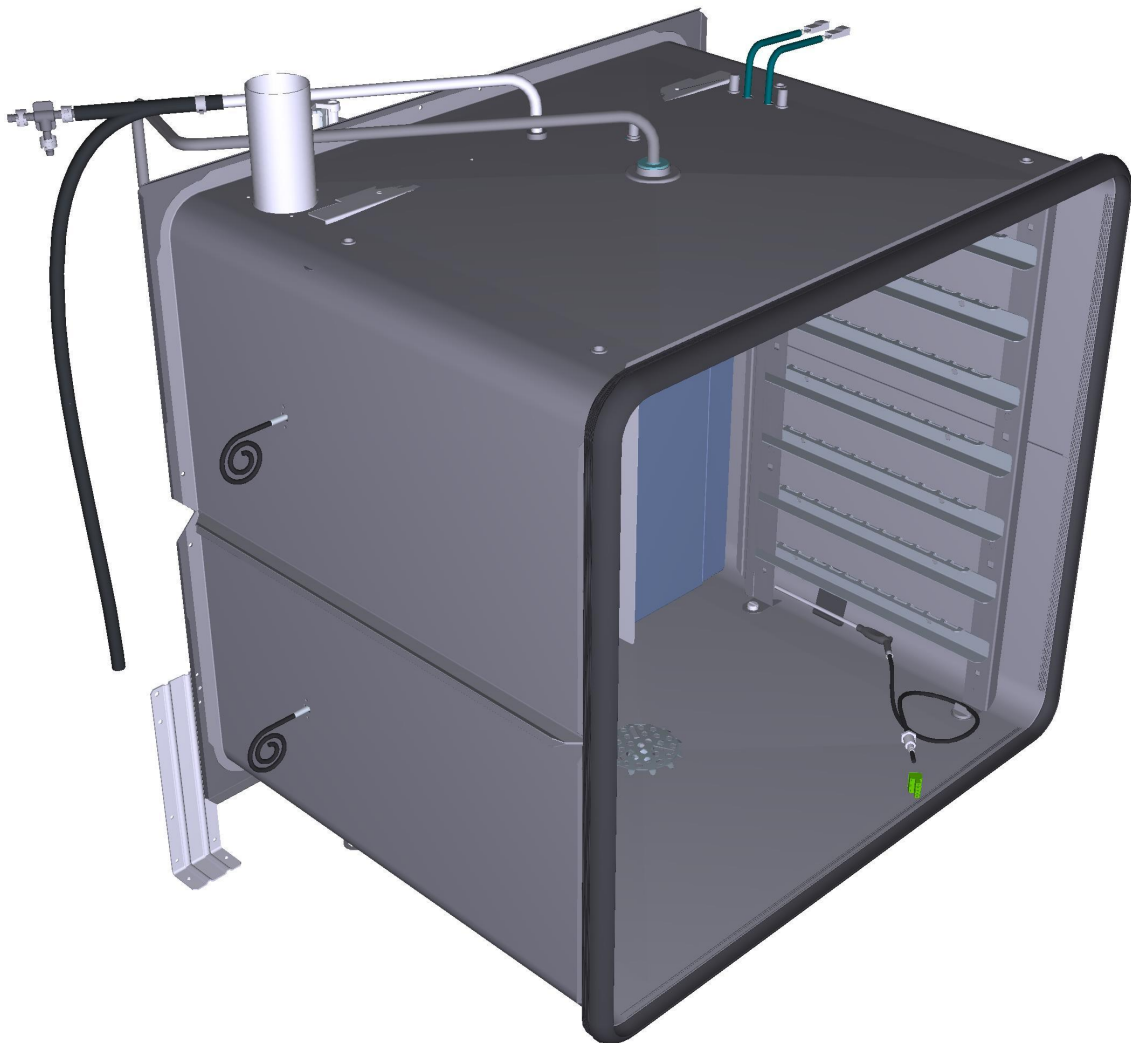

ASM2912A/0.D02 - Chambre de cuisson - FACE AVANT

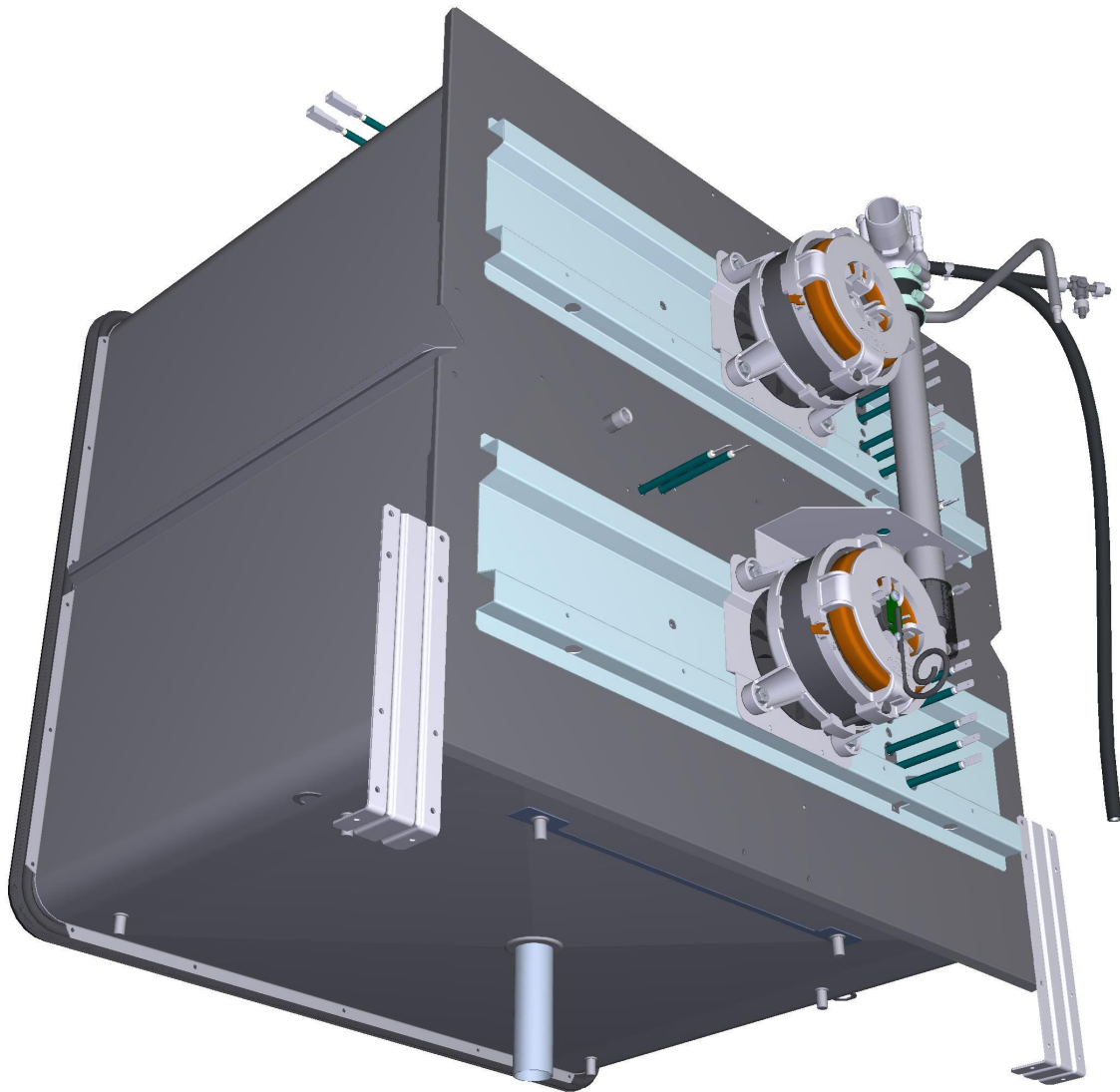

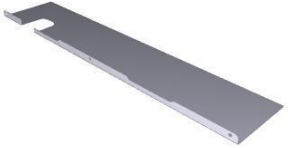

ASM2912A/0.D02 - Chambre de cuisson - ARRIÈRE

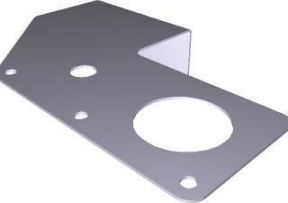







COMPOSANT			PIÈCE DE RECHANGE																		
Code	Description	Image	Code	Description	Composants du kit																
OG1558A	FAN GUARD SPACE		K0G1558A	KIT ECARTEUR CARTER	<table border="1"> <thead> <tr> <th>Code</th> <th>Description</th> <th>Qté</th> <th>UOM</th> </tr> </thead> <tbody> <tr> <td>0G1183A1</td> <td>ENTRETOISE CARTER 316L</td> <td>1.000</td> <td>PCS</td> </tr> </tbody> </table>	Code	Description	Qté	UOM	0G1183A1	ENTRETOISE CARTER 316L	1.000	PCS								
Code	Description	Qté	UOM																		
0G1183A1	ENTRETOISE CARTER 316L	1.000	PCS																		
0H2551A	GRILLE POUR TUYAU DECHARGE LIQUIDES		K0H2551A	BOUCHON POUR TUYAU DECHARGE LIQUIDES	<table border="1"> <thead> <tr> <th>Code</th> <th>Description</th> <th>Qté</th> <th>UOM</th> </tr> </thead> <tbody> <tr> <td>0H2617A0</td> <td>GRILLE DE TUYAU VIDANGE AISI316</td> <td>1.000</td> <td>PCS</td> </tr> </tbody> </table>	Code	Description	Qté	UOM	0H2617A0	GRILLE DE TUYAU VIDANGE AISI316	1.000	PCS								
Code	Description	Qté	UOM																		
0H2617A0	GRILLE DE TUYAU VIDANGE AISI316	1.000	PCS																		
0H2730A	SUPPORT ZINGUE FIXATION MOUFLE		0H2730A1	SUPPORT ZINGUE FIXATION MOUFLE																	
0H7320A	SUPPORT TUBE VENTURI MM		0H7320A0	SUPPORT TUBE VENTURI MM																	
PE1710B	MOTOR REVOLUTION AND DIRECTION SENSO		KPE1710B	KIT CAPTEUR N. TOURS MOTEUR	<table border="1"> <thead> <tr> <th>Code</th> <th>Description</th> <th>Qté</th> <th>UOM</th> </tr> </thead> <tbody> <tr> <td>CE1119A0</td> <td>CABLE AMPMODU2 4P 4xAWG22 L1500 RAST 4</td> <td>1.000</td> <td>PCS</td> </tr> <tr> <td>PE1040A0</td> <td>SENSEUR RAST NOMBRES TOURS+VERS MOTEUR</td> <td>1.000</td> <td>PCS</td> </tr> <tr> <td>VI1966A1</td> <td>VIS M4X14 TSP+ ZN</td> <td>1.000</td> <td>PCS</td> </tr> </tbody> </table>	Code	Description	Qté	UOM	CE1119A0	CABLE AMPMODU2 4P 4xAWG22 L1500 RAST 4	1.000	PCS	PE1040A0	SENSEUR RAST NOMBRES TOURS+VERS MOTEUR	1.000	PCS	VI1966A1	VIS M4X14 TSP+ ZN	1.000	PCS
Code	Description	Qté	UOM																		
CE1119A0	CABLE AMPMODU2 4P 4xAWG22 L1500 RAST 4	1.000	PCS																		
PE1040A0	SENSEUR RAST NOMBRES TOURS+VERS MOTEUR	1.000	PCS																		
VI1966A1	VIS M4X14 TSP+ ZN	1.000	PCS																		

COMPOSANT			PIÈCE DE RECHANGE															
Code	Description	Image	Code	Description	Composants du kit													
VE1550A	AIMANT NEODYME 5X3 MM		KVP1964A	KIT COUVERTURE EXT POIGNEE CBX	<table border="1"> <thead> <tr> <th>Code</th> <th>Description</th> <th>Qté</th> <th>UOM</th> </tr> </thead> <tbody> <tr> <td>VI1168A0</td> <td></td> <td>2.000</td> <td>PCS</td> </tr> <tr> <td>VP1964A0</td> <td>COUCHE INTERNE POIGNEE AVEC AIMANS CBX</td> <td>1.000</td> <td>PCS</td> </tr> </tbody> </table>	Code	Description	Qté	UOM	VI1168A0		2.000	PCS	VP1964A0	COUCHE INTERNE POIGNEE AVEC AIMANS CBX	1.000	PCS	
			Code	Description	Qté	UOM												
			VI1168A0		2.000	PCS												
			VP1964A0	COUCHE INTERNE POIGNEE AVEC AIMANS CBX	1.000	PCS												
KVM2620A	KIT EMBOUT POGNEE A LANCER BIG L-GAUCHE	<table border="1"> <thead> <tr> <th>Code</th> <th>Description</th> <th>Qté</th> <th>UOM</th> </tr> </thead> <tbody> <tr> <td>0H8033A0</td> <td>RONDELLE IMPRIME FIXATION POIGNEE BIG</td> <td>1.000</td> <td>PCS</td> </tr> <tr> <td>VI1117A0</td> <td>M5x20 FLAT COUNTERSUN K HEAD SCRE</td> <td>1.000</td> <td>PCS</td> </tr> <tr> <td>VM2886A0</td> <td>ENS STYLO AIMAINTS POIGNEE LANC BIG GAU</td> <td>1.000</td> <td>PCS</td> </tr> </tbody> </table>	Code	Description	Qté	UOM	0H8033A0	RONDELLE IMPRIME FIXATION POIGNEE BIG	1.000	PCS	VI1117A0	M5x20 FLAT COUNTERSUN K HEAD SCRE	1.000	PCS	VM2886A0	ENS STYLO AIMAINTS POIGNEE LANC BIG GAU	1.000	PCS
Code	Description	Qté	UOM															
0H8033A0	RONDELLE IMPRIME FIXATION POIGNEE BIG	1.000	PCS															
VI1117A0	M5x20 FLAT COUNTERSUN K HEAD SCRE	1.000	PCS															
VM2886A0	ENS STYLO AIMAINTS POIGNEE LANC BIG GAU	1.000	PCS															
KVM2587B	KIT EMBOUT POIGNEE A LANCER BIG-L DROITE	<table border="1"> <thead> <tr> <th>Code</th> <th>Description</th> <th>Qté</th> <th>UOM</th> </tr> </thead> <tbody> <tr> <td>0H8033A0</td> <td>RONDELLE IMPRIME FIXATION POIGNEE BIG</td> <td>1.000</td> <td>PCS</td> </tr> <tr> <td>VI1117A0</td> <td>M5x20 FLAT COUNTERSUN K HEAD SCRE</td> <td>1.000</td> <td>PCS</td> </tr> <tr> <td>VM2887A0</td> <td>ENS STYLO AIMAINTS POIGNEE LANC BIG DRO</td> <td>1.000</td> <td>PCS</td> </tr> </tbody> </table>	Code	Description	Qté	UOM	0H8033A0	RONDELLE IMPRIME FIXATION POIGNEE BIG	1.000	PCS	VI1117A0	M5x20 FLAT COUNTERSUN K HEAD SCRE	1.000	PCS	VM2887A0	ENS STYLO AIMAINTS POIGNEE LANC BIG DRO	1.000	PCS
Code	Description	Qté	UOM															
0H8033A0	RONDELLE IMPRIME FIXATION POIGNEE BIG	1.000	PCS															
VI1117A0	M5x20 FLAT COUNTERSUN K HEAD SCRE	1.000	PCS															
VM2887A0	ENS STYLO AIMAINTS POIGNEE LANC BIG DRO	1.000	PCS															
KPE1710B	KIT CAPTEUR N. TOURS MOTEUR	<table border="1"> <thead> <tr> <th>Code</th> <th>Description</th> <th>Qté</th> <th>UOM</th> </tr> </thead> <tbody> <tr> <td>CE1119A0</td> <td>CABLE AMPMODU2 4P 4xAWG22 L1500 RAST 4</td> <td>1.000</td> <td>PCS</td> </tr> <tr> <td>PE1040A0</td> <td>SENSEUR RAST NOMBRES TOURS+VERS MOTEUR</td> <td>1.000</td> <td>PCS</td> </tr> <tr> <td>VI1966A1</td> <td>VIS M4X14 TSP+ ZN</td> <td>1.000</td> <td>PCS</td> </tr> </tbody> </table>	Code	Description	Qté	UOM	CE1119A0	CABLE AMPMODU2 4P 4xAWG22 L1500 RAST 4	1.000	PCS	PE1040A0	SENSEUR RAST NOMBRES TOURS+VERS MOTEUR	1.000	PCS	VI1966A1	VIS M4X14 TSP+ ZN	1.000	PCS
Code	Description	Qté	UOM															
CE1119A0	CABLE AMPMODU2 4P 4xAWG22 L1500 RAST 4	1.000	PCS															
PE1040A0	SENSEUR RAST NOMBRES TOURS+VERS MOTEUR	1.000	PCS															
VI1966A1	VIS M4X14 TSP+ ZN	1.000	PCS															
KMT1036A	KIT MOTEUR TRIPH 400W 200-240V 3300RPM	<table border="1"> <thead> <tr> <th>Code</th> <th>Description</th> <th>Qté</th> <th>UOM</th> </tr> </thead> <tbody> <tr> <td>0H3966A0</td> <td>MASQUE CENTRAGE MOTEUR ST</td> <td>1.000</td> <td>PCS</td> </tr> </tbody> </table>	Code	Description	Qté	UOM	0H3966A0	MASQUE CENTRAGE MOTEUR ST	1.000	PCS								
Code	Description	Qté	UOM															
0H3966A0	MASQUE CENTRAGE MOTEUR ST	1.000	PCS															

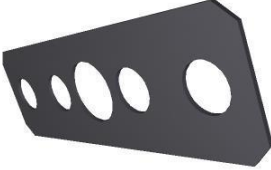

COMPOSANT			PIÈCE DE RECHANGE																																						
Code	Description	Image	Code	Description	Composants du kit																																				
VE1550A	AIMANT NEODYME 5X3 MM		KMT1036A	KIT MOTEUR TRIPH 400W 200-240V 3300RPM	<table border="1"> <thead> <tr> <th>Code</th> <th>Description</th> <th>Qté</th> <th>UOM</th> </tr> </thead> <tbody> <tr> <td>0H5494A0</td> <td>JOINT EMI CHOKE ARBRE MOTEUR</td> <td>1.000</td> <td>PCS</td> </tr> <tr> <td>0H8118A0</td> <td>DISQUE TENUE ARBRE MOTEUR XEVL</td> <td>1.000</td> <td>PCS</td> </tr> <tr> <td>GN1140A3</td> <td>JOINT SUPPORT MOTEUR IMPRIME</td> <td>1.000</td> <td>PCS</td> </tr> <tr> <td>MT1036A0</td> <td>MT1029A AVEC MODIF. CIRCUIT THERMIQUE</td> <td>1.000</td> <td>PCS</td> </tr> <tr> <td>VI1077A1</td> <td>VIS M6X12 TE INOX</td> <td>1.000</td> <td>PCS</td> </tr> <tr> <td>VI1521A0</td> <td>RONDELLE PLATE INOX 6x12x1</td> <td>1.000</td> <td>PCS</td> </tr> <tr> <td>VI1966A1</td> <td>VIS M4X14 TSP+ ZN</td> <td>1.000</td> <td>PCS</td> </tr> <tr> <td>VM2680A0</td> <td>ENS AIMANT PR LA MESURE DU NOMBRE TOURS</td> <td>1.000</td> <td>PCS</td> </tr> </tbody> </table>	Code	Description	Qté	UOM	0H5494A0	JOINT EMI CHOKE ARBRE MOTEUR	1.000	PCS	0H8118A0	DISQUE TENUE ARBRE MOTEUR XEVL	1.000	PCS	GN1140A3	JOINT SUPPORT MOTEUR IMPRIME	1.000	PCS	MT1036A0	MT1029A AVEC MODIF. CIRCUIT THERMIQUE	1.000	PCS	VI1077A1	VIS M6X12 TE INOX	1.000	PCS	VI1521A0	RONDELLE PLATE INOX 6x12x1	1.000	PCS	VI1966A1	VIS M4X14 TSP+ ZN	1.000	PCS	VM2680A0	ENS AIMANT PR LA MESURE DU NOMBRE TOURS	1.000	PCS
			Code	Description	Qté	UOM																																			
0H5494A0	JOINT EMI CHOKE ARBRE MOTEUR	1.000	PCS																																						
0H8118A0	DISQUE TENUE ARBRE MOTEUR XEVL	1.000	PCS																																						
GN1140A3	JOINT SUPPORT MOTEUR IMPRIME	1.000	PCS																																						
MT1036A0	MT1029A AVEC MODIF. CIRCUIT THERMIQUE	1.000	PCS																																						
VI1077A1	VIS M6X12 TE INOX	1.000	PCS																																						
VI1521A0	RONDELLE PLATE INOX 6x12x1	1.000	PCS																																						
VI1966A1	VIS M4X14 TSP+ ZN	1.000	PCS																																						
VM2680A0	ENS AIMANT PR LA MESURE DU NOMBRE TOURS	1.000	PCS																																						
KMT1029A	KIT MOTEUR TRIPH 400W 200-240V 3300RPM	<table border="1"> <thead> <tr> <th>Code</th> <th>Description</th> <th>Qté</th> <th>UOM</th> </tr> </thead> <tbody> <tr> <td>0H3966A0</td> <td>MASQUE CENTRAGE MOTEUR ST</td> <td>1.000</td> <td>PCS</td> </tr> <tr> <td>0H5494A0</td> <td>JOINT EMI CHOKE ARBRE MOTEUR</td> <td>1.000</td> <td>PCS</td> </tr> <tr> <td>0H8118A0</td> <td>DISQUE TENUE ARBRE MOTEUR XEVL</td> <td>1.000</td> <td>PCS</td> </tr> <tr> <td>GN1140A3</td> <td>JOINT SUPPORT MOTEUR IMPRIME</td> <td>1.000</td> <td>PCS</td> </tr> <tr> <td>MT1029A0</td> <td>3300RPM 400W 3PH MOTOR</td> <td>1.000</td> <td>PCS</td> </tr> <tr> <td>VI1077A1</td> <td>VIS M6X12 TE INOX</td> <td>1.000</td> <td>PCS</td> </tr> <tr> <td>VI1521A0</td> <td>RONDELLE PLATE INOX 6x12x1</td> <td>1.000</td> <td>PCS</td> </tr> <tr> <td>VI1966A1</td> <td>VIS M4X14 TSP+ ZN</td> <td>1.000</td> <td>PCS</td> </tr> </tbody> </table>	Code	Description	Qté	UOM	0H3966A0	MASQUE CENTRAGE MOTEUR ST	1.000	PCS	0H5494A0	JOINT EMI CHOKE ARBRE MOTEUR	1.000	PCS	0H8118A0	DISQUE TENUE ARBRE MOTEUR XEVL	1.000	PCS	GN1140A3	JOINT SUPPORT MOTEUR IMPRIME	1.000	PCS	MT1029A0	3300RPM 400W 3PH MOTOR	1.000	PCS	VI1077A1	VIS M6X12 TE INOX	1.000	PCS	VI1521A0	RONDELLE PLATE INOX 6x12x1	1.000	PCS	VI1966A1	VIS M4X14 TSP+ ZN	1.000	PCS			
Code	Description	Qté	UOM																																						
0H3966A0	MASQUE CENTRAGE MOTEUR ST	1.000	PCS																																						
0H5494A0	JOINT EMI CHOKE ARBRE MOTEUR	1.000	PCS																																						
0H8118A0	DISQUE TENUE ARBRE MOTEUR XEVL	1.000	PCS																																						
GN1140A3	JOINT SUPPORT MOTEUR IMPRIME	1.000	PCS																																						
MT1029A0	3300RPM 400W 3PH MOTOR	1.000	PCS																																						
VI1077A1	VIS M6X12 TE INOX	1.000	PCS																																						
VI1521A0	RONDELLE PLATE INOX 6x12x1	1.000	PCS																																						
VI1966A1	VIS M4X14 TSP+ ZN	1.000	PCS																																						

COMPOSANT			PIÈCE DE RECHANGE																															
Code	Description	Image	Code	Description	Composants du kit																													
VE1550A	AIMANT NEODYME 5X3 MM		KMT1029A	KIT MOTEUR TRIPH 400W 200-240V 3300RPM	<table border="1"> <thead> <tr> <th>Code</th> <th>Description</th> <th>Qté</th> <th>UOM</th> </tr> </thead> <tbody> <tr> <td>VM1794A0</td> <td>PLAQUETTE NOIRE 250X4.8 PA66</td> <td>4.000</td> <td>PCS</td> </tr> <tr> <td>VM2103A0</td> <td>PLAQUETTE FERMETURE COLLIER</td> <td>3.000</td> <td>PCS</td> </tr> <tr> <td>VM2880A0</td> <td>ENS AIMANT PR LA MESURE DU NOMBRE TOURS</td> <td>1.000</td> <td>PCS</td> </tr> </tbody> </table>	Code	Description	Qté	UOM	VM1794A0	PLAQUETTE NOIRE 250X4.8 PA66	4.000	PCS	VM2103A0	PLAQUETTE FERMETURE COLLIER	3.000	PCS	VM2880A0	ENS AIMANT PR LA MESURE DU NOMBRE TOURS	1.000	PCS													
			Code		Description	Qté	UOM																											
VM1794A0	PLAQUETTE NOIRE 250X4.8 PA66	4.000	PCS																															
VM2103A0	PLAQUETTE FERMETURE COLLIER	3.000	PCS																															
VM2880A0	ENS AIMANT PR LA MESURE DU NOMBRE TOURS	1.000	PCS																															
KMT1012A	KIT MOTEUR 330W MIND.MAPS / LUX >08.2017	<table border="1"> <thead> <tr> <th>Code</th> <th>Description</th> <th>Qté</th> <th>UOM</th> </tr> </thead> <tbody> <tr> <td>0H2842A0</td> <td>BRIDE DE CENTRAGE MT1012</td> <td>1.000</td> <td>PCS</td> </tr> <tr> <td>0H8118A0</td> <td>DISQUE TENUE ARBRE MOTEUR XEVL</td> <td>1.000</td> <td>PCS</td> </tr> <tr> <td>GN1140A3</td> <td>JOINT SUPPORT MOTEUR IMPRIME</td> <td>1.000</td> <td>PCS</td> </tr> <tr> <td>MT1012A0</td> <td>MOTEUR 330W 230V</td> <td>1.000</td> <td>PCS</td> </tr> <tr> <td>VI1077A1</td> <td>VIS M6X12 TE INOX</td> <td>1.000</td> <td>PCS</td> </tr> <tr> <td>VI1521A0</td> <td>RONDELLE PLATE INOX 6x12x1</td> <td>1.000</td> <td>PCS</td> </tr> <tr> <td>VI1966A1</td> <td>VIS M4X14 TSP+ ZN</td> <td>1.000</td> <td>PCS</td> </tr> </tbody> </table>	Code	Description	Qté	UOM	0H2842A0	BRIDE DE CENTRAGE MT1012	1.000	PCS	0H8118A0	DISQUE TENUE ARBRE MOTEUR XEVL	1.000	PCS	GN1140A3	JOINT SUPPORT MOTEUR IMPRIME	1.000	PCS	MT1012A0	MOTEUR 330W 230V	1.000	PCS	VI1077A1	VIS M6X12 TE INOX	1.000	PCS	VI1521A0	RONDELLE PLATE INOX 6x12x1	1.000	PCS	VI1966A1	VIS M4X14 TSP+ ZN	1.000	PCS
Code	Description	Qté	UOM																															
0H2842A0	BRIDE DE CENTRAGE MT1012	1.000	PCS																															
0H8118A0	DISQUE TENUE ARBRE MOTEUR XEVL	1.000	PCS																															
GN1140A3	JOINT SUPPORT MOTEUR IMPRIME	1.000	PCS																															
MT1012A0	MOTEUR 330W 230V	1.000	PCS																															
VI1077A1	VIS M6X12 TE INOX	1.000	PCS																															
VI1521A0	RONDELLE PLATE INOX 6x12x1	1.000	PCS																															
VI1966A1	VIS M4X14 TSP+ ZN	1.000	PCS																															
GN1085A	JOINT RESISTANCE 141x24 G6.25		KG1086A	KIT 5 PCS JOINT RESISTANCE 141X2	<table border="1"> <thead> <tr> <th>Code</th> <th>Description</th> <th>Qté</th> <th>UOM</th> </tr> </thead> <tbody> <tr> <td>GN1086A0</td> <td>JOINT RESISTANCE 141x22 G8.5</td> <td>5.000</td> <td>PCS</td> </tr> </tbody> </table>	Code	Description	Qté	UOM	GN1086A0	JOINT RESISTANCE 141x22 G8.5	5.000	PCS																					
Code	Description	Qté	UOM																															
GN1086A0	JOINT RESISTANCE 141x22 G8.5	5.000	PCS																															
RS1205A	RES CIRCULAIRE 5.6kW 230V D230 6 SPIRES		KRS1205B	KIT RESISTANCE 5600W 230V RS1205	<table border="1"> <thead> <tr> <th>Code</th> <th>Description</th> <th>Qté</th> <th>UOM</th> </tr> </thead> <tbody> <tr> <td>GN1671A0</td> <td>JOINT RES 141X22 G8.5 ARMEE</td> <td>1.000</td> <td>PCS</td> </tr> <tr> <td>RS1205B0</td> <td>RESIST CIRCUL 5600W 230V D230 6 SPIRES</td> <td>1.000</td> <td>PCS</td> </tr> <tr> <td>SL1045A0</td> <td>SILICONE ANTHRACITE S57 sp-5007 80ml</td> <td>1.000</td> <td>PCS</td> </tr> </tbody> </table>	Code	Description	Qté	UOM	GN1671A0	JOINT RES 141X22 G8.5 ARMEE	1.000	PCS	RS1205B0	RESIST CIRCUL 5600W 230V D230 6 SPIRES	1.000	PCS	SL1045A0	SILICONE ANTHRACITE S57 sp-5007 80ml	1.000	PCS													
Code	Description	Qté	UOM																															
GN1671A0	JOINT RES 141X22 G8.5 ARMEE	1.000	PCS																															
RS1205B0	RESIST CIRCUL 5600W 230V D230 6 SPIRES	1.000	PCS																															
SL1045A0	SILICONE ANTHRACITE S57 sp-5007 80ml	1.000	PCS																															

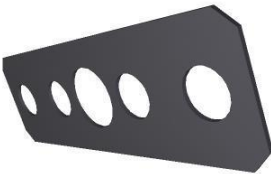
COMPOSANT			PIÈCE DE RECHANGE																						
Code	Description	Image	Code	Description	Composants du kit																				
RS1205A	RES CIRCULAIRE 5.6kW 230V D230 6 SPIRES		KRS1205B	KIT RESISTANCE 5600W 230V RS1205	<table border="1"> <thead> <tr> <th>Code</th> <th>Description</th> <th>Qté</th> <th>UOM</th> </tr> </thead> <tbody> <tr> <td>VI1032A0</td> <td>VIS M4x16 TCB+ INOX A2 DIN 7985</td> <td>1.000</td> <td>PCS</td> </tr> <tr> <td>VI1075A0</td> <td>FR-DADO M4 H=4 INOX UNI5587</td> <td>1.000</td> <td>PCS</td> </tr> <tr> <td>VI1220A1</td> <td>VIS AUTOTARADE UX 4.2x12 TCB MARUTEX PRE</td> <td>6.000</td> <td>PCS</td> </tr> <tr> <td>VI1511A0</td> <td>RONDELLE PLATE 4.2X12X1 INOX</td> <td>1.000</td> <td>PCS</td> </tr> </tbody> </table>	Code	Description	Qté	UOM	VI1032A0	VIS M4x16 TCB+ INOX A2 DIN 7985	1.000	PCS	VI1075A0	FR-DADO M4 H=4 INOX UNI5587	1.000	PCS	VI1220A1	VIS AUTOTARADE UX 4.2x12 TCB MARUTEX PRE	6.000	PCS	VI1511A0	RONDELLE PLATE 4.2X12X1 INOX	1.000	PCS
Code	Description	Qté	UOM																						
VI1032A0	VIS M4x16 TCB+ INOX A2 DIN 7985	1.000	PCS																						
VI1075A0	FR-DADO M4 H=4 INOX UNI5587	1.000	PCS																						
VI1220A1	VIS AUTOTARADE UX 4.2x12 TCB MARUTEX PRE	6.000	PCS																						
VI1511A0	RONDELLE PLATE 4.2X12X1 INOX	1.000	PCS																						
GN1326A	JOINT RESISTANCE 71x19 G6.25		KRS1274A	KIT RESISTANCE DE FRAINAGE 100W	<table border="1"> <thead> <tr> <th>Code</th> <th>Description</th> <th>Qté</th> <th>UOM</th> </tr> </thead> <tbody> <tr> <td>GN1672A1</td> <td>JOINT RESISTANCE FREIN</td> <td>1.000</td> <td>PCS</td> </tr> <tr> <td>RS1274A0</td> <td>RESISTANCE PLATE 100W 60V 1 TOUR</td> <td>1.000</td> <td>PCS</td> </tr> <tr> <td>SL1045A0</td> <td>SILICONE ANTHRACITE S57 sp-5007 80ml</td> <td>1.000</td> <td>PCS</td> </tr> <tr> <td>VI1220A1</td> <td>VIS AUTOTARADE UX 4.2x12 TCB MARUTEX PRE</td> <td>2.000</td> <td>PCS</td> </tr> </tbody> </table>	Code	Description	Qté	UOM	GN1672A1	JOINT RESISTANCE FREIN	1.000	PCS	RS1274A0	RESISTANCE PLATE 100W 60V 1 TOUR	1.000	PCS	SL1045A0	SILICONE ANTHRACITE S57 sp-5007 80ml	1.000	PCS	VI1220A1	VIS AUTOTARADE UX 4.2x12 TCB MARUTEX PRE	2.000	PCS
Code	Description	Qté	UOM																						
GN1672A1	JOINT RESISTANCE FREIN	1.000	PCS																						
RS1274A0	RESISTANCE PLATE 100W 60V 1 TOUR	1.000	PCS																						
SL1045A0	SILICONE ANTHRACITE S57 sp-5007 80ml	1.000	PCS																						
VI1220A1	VIS AUTOTARADE UX 4.2x12 TCB MARUTEX PRE	2.000	PCS																						
			KRS1261A	KIT RESISTANCE DE FREINAGE 122W	<table border="1"> <thead> <tr> <th>Code</th> <th>Description</th> <th>Qté</th> <th>UOM</th> </tr> </thead> <tbody> <tr> <td>GN1326A1</td> <td>JOINT RESISTANCE 71x19 G6.25</td> <td>1.000</td> <td>PCS</td> </tr> <tr> <td>RS1261A0</td> <td>RESISTANCE MOTEUR BAKERLUXCH EFLUX</td> <td>1.000</td> <td>PCS</td> </tr> <tr> <td>SL1045A0</td> <td>SILICONE ANTHRACITE S57 sp-5007 80ml</td> <td>1.000</td> <td>PCS</td> </tr> <tr> <td>VI1220A1</td> <td>VIS AUTOTARADE UX 4.2x12 TCB MARUTEX PRE</td> <td>2.000</td> <td>PCS</td> </tr> </tbody> </table>	Code	Description	Qté	UOM	GN1326A1	JOINT RESISTANCE 71x19 G6.25	1.000	PCS	RS1261A0	RESISTANCE MOTEUR BAKERLUXCH EFLUX	1.000	PCS	SL1045A0	SILICONE ANTHRACITE S57 sp-5007 80ml	1.000	PCS	VI1220A1	VIS AUTOTARADE UX 4.2x12 TCB MARUTEX PRE	2.000	PCS
Code	Description	Qté	UOM																						
GN1326A1	JOINT RESISTANCE 71x19 G6.25	1.000	PCS																						
RS1261A0	RESISTANCE MOTEUR BAKERLUXCH EFLUX	1.000	PCS																						
SL1045A0	SILICONE ANTHRACITE S57 sp-5007 80ml	1.000	PCS																						
VI1220A1	VIS AUTOTARADE UX 4.2x12 TCB MARUTEX PRE	2.000	PCS																						
			KRS1215A	KIT RESISTANCE DE FRAINAGE 147W	<table border="1"> <thead> <tr> <th>Code</th> <th>Description</th> <th>Qté</th> <th>UOM</th> </tr> </thead> <tbody> <tr> <td>GN1672A1</td> <td>JOINT RESISTANCE FREIN</td> <td>1.000</td> <td>PCS</td> </tr> <tr> <td>RS1215A1</td> <td>RES PLATE 147W 105V D230 1 SPIRE</td> <td>1.000</td> <td>PCS</td> </tr> </tbody> </table>	Code	Description	Qté	UOM	GN1672A1	JOINT RESISTANCE FREIN	1.000	PCS	RS1215A1	RES PLATE 147W 105V D230 1 SPIRE	1.000	PCS								
Code	Description	Qté	UOM																						
GN1672A1	JOINT RESISTANCE FREIN	1.000	PCS																						
RS1215A1	RES PLATE 147W 105V D230 1 SPIRE	1.000	PCS																						

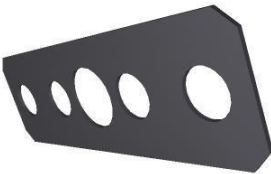
COMPOSANT			PIÈCE DE RECHANGE																			
Code	Description	Image	Code	Description	Composants du kit																	
GN1326A	JOINT RESISTANCE 71x19 G6.25		KRS1215A	KIT RESISTANCE DE FRAINAGE 147W	<table border="1"> <thead> <tr> <th>Code</th> <th>Description</th> <th>Qté</th> <th>UOM</th> </tr> </thead> <tbody> <tr> <td>SL1045A0</td> <td>SILICONE ANTHRACITE S57 sp-5007 80ml</td> <td>1.000</td> <td>PCS</td> </tr> <tr> <td>VI1220A1</td> <td>VIS AUTOTARADE UX 4.2x12 TCB MARUTEX PRE</td> <td>2.000</td> <td>PCS</td> </tr> </tbody> </table>	Code	Description	Qté	UOM	SL1045A0	SILICONE ANTHRACITE S57 sp-5007 80ml	1.000	PCS	VI1220A1	VIS AUTOTARADE UX 4.2x12 TCB MARUTEX PRE	2.000	PCS					
			Code	Description	Qté	UOM																
			SL1045A0	SILICONE ANTHRACITE S57 sp-5007 80ml	1.000	PCS																
			VI1220A1	VIS AUTOTARADE UX 4.2x12 TCB MARUTEX PRE	2.000	PCS																
KRS1095A	KIT RESISTANCE 1.2kW	<table border="1"> <thead> <tr> <th>Code</th> <th>Description</th> <th>Qté</th> <th>UOM</th> </tr> </thead> <tbody> <tr> <td>GN1326A1</td> <td>JOINT RESISTANCE 71x19 G6.25</td> <td>1.000</td> <td>PCS</td> </tr> <tr> <td>RS1095A1</td> <td>HEATING ELEMENT 1200W 230V</td> <td>1.000</td> <td>PCS</td> </tr> <tr> <td>SL1045A0</td> <td>SILICONE ANTHRACITE S57 sp-5007 80ml</td> <td>1.000</td> <td>PCS</td> </tr> <tr> <td>VI1220A1</td> <td>VIS AUTOTARADE UX 4.2x12 TCB MARUTEX PRE</td> <td>2.000</td> <td>PCS</td> </tr> </tbody> </table>	Code	Description	Qté	UOM	GN1326A1	JOINT RESISTANCE 71x19 G6.25	1.000	PCS	RS1095A1	HEATING ELEMENT 1200W 230V	1.000	PCS	SL1045A0	SILICONE ANTHRACITE S57 sp-5007 80ml	1.000	PCS	VI1220A1	VIS AUTOTARADE UX 4.2x12 TCB MARUTEX PRE	2.000	PCS
Code	Description	Qté	UOM																			
GN1326A1	JOINT RESISTANCE 71x19 G6.25	1.000	PCS																			
RS1095A1	HEATING ELEMENT 1200W 230V	1.000	PCS																			
SL1045A0	SILICONE ANTHRACITE S57 sp-5007 80ml	1.000	PCS																			
VI1220A1	VIS AUTOTARADE UX 4.2x12 TCB MARUTEX PRE	2.000	PCS																			
KRS1012A	KIT RESISTANCE 1365W 120V	<table border="1"> <thead> <tr> <th>Code</th> <th>Description</th> <th>Qté</th> <th>UOM</th> </tr> </thead> <tbody> <tr> <td>GN1326A1</td> <td>JOINT RESISTANCE 71x19 G6.25</td> <td>1.000</td> <td>PCS</td> </tr> <tr> <td>RS1012A0</td> <td>CIRCULAR ELEMENT 1365W 120V</td> <td>1.000</td> <td>PCS</td> </tr> <tr> <td>VI1220A1</td> <td>VIS AUTOTARADE UX 4.2x12 TCB MARUTEX PRE</td> <td>5.000</td> <td>PCS</td> </tr> </tbody> </table>	Code	Description	Qté	UOM	GN1326A1	JOINT RESISTANCE 71x19 G6.25	1.000	PCS	RS1012A0	CIRCULAR ELEMENT 1365W 120V	1.000	PCS	VI1220A1	VIS AUTOTARADE UX 4.2x12 TCB MARUTEX PRE	5.000	PCS				
Code	Description	Qté	UOM																			
GN1326A1	JOINT RESISTANCE 71x19 G6.25	1.000	PCS																			
RS1012A0	CIRCULAR ELEMENT 1365W 120V	1.000	PCS																			
VI1220A1	VIS AUTOTARADE UX 4.2x12 TCB MARUTEX PRE	5.000	PCS																			
KRS1011A	KIT RESISTANCE ROBERTA/LISA	<table border="1"> <thead> <tr> <th>Code</th> <th>Description</th> <th>Qté</th> <th>UOM</th> </tr> </thead> <tbody> <tr> <td>GN1326A1</td> <td>JOINT RESISTANCE 71x19 G6.25</td> <td>1.000</td> <td>PCS</td> </tr> <tr> <td>RS1011A0</td> <td>RESISTENCE CIRCULAIRE 2560W 220-230</td> <td>1.000</td> <td>PCS</td> </tr> <tr> <td>SL1045A0</td> <td>SILICONE ANTHRACITE S57 sp-5007 80ml</td> <td>1.000</td> <td>PCS</td> </tr> <tr> <td>VI1220A1</td> <td>VIS AUTOTARADE UX 4.2x12 TCB MARUTEX PRE</td> <td>5.000</td> <td>PCS</td> </tr> </tbody> </table>	Code	Description	Qté	UOM	GN1326A1	JOINT RESISTANCE 71x19 G6.25	1.000	PCS	RS1011A0	RESISTENCE CIRCULAIRE 2560W 220-230	1.000	PCS	SL1045A0	SILICONE ANTHRACITE S57 sp-5007 80ml	1.000	PCS	VI1220A1	VIS AUTOTARADE UX 4.2x12 TCB MARUTEX PRE	5.000	PCS
Code	Description	Qté	UOM																			
GN1326A1	JOINT RESISTANCE 71x19 G6.25	1.000	PCS																			
RS1011A0	RESISTENCE CIRCULAIRE 2560W 220-230	1.000	PCS																			
SL1045A0	SILICONE ANTHRACITE S57 sp-5007 80ml	1.000	PCS																			
VI1220A1	VIS AUTOTARADE UX 4.2x12 TCB MARUTEX PRE	5.000	PCS																			

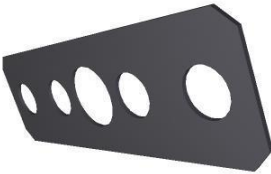

COMPOSANT			PIÈCE DE RECHANGE																										
Code	Description	Image	Code	Description	Composants du kit																								
GN1326A	JOINT RESISTANCE 71x19 G6.25		KRS0090A	KIT RESISTANCE 1.26kW RS0090A	<table border="1"> <thead> <tr> <th>Code</th> <th>Description</th> <th>Qté</th> <th>UOM</th> </tr> </thead> <tbody> <tr> <td>GN1326A1</td> <td>JOINT RESISTANCE 71x19 G6.25</td> <td>1.000</td> <td>PCS</td> </tr> <tr> <td>RS0090A0</td> <td>CIRC. HEAT. ELEMENT 1260W 220-230</td> <td>1.000</td> <td>PCS</td> </tr> <tr> <td>VI1220A1</td> <td>VIS AUTOTARADE UX 4.2x12 TCB MARUTEX PRE</td> <td>3.000</td> <td>PCS</td> </tr> <tr> <td>VM1794A0</td> <td>PLAQUETTE NOIRE 250X4.8 PA66</td> <td>2.000</td> <td>PCS</td> </tr> <tr> <td>VM2103A0</td> <td>PLAQUETTE FERMETURE COLLIER</td> <td>2.000</td> <td>PCS</td> </tr> </tbody> </table>	Code	Description	Qté	UOM	GN1326A1	JOINT RESISTANCE 71x19 G6.25	1.000	PCS	RS0090A0	CIRC. HEAT. ELEMENT 1260W 220-230	1.000	PCS	VI1220A1	VIS AUTOTARADE UX 4.2x12 TCB MARUTEX PRE	3.000	PCS	VM1794A0	PLAQUETTE NOIRE 250X4.8 PA66	2.000	PCS	VM2103A0	PLAQUETTE FERMETURE COLLIER	2.000	PCS
			Code	Description	Qté	UOM																							
			GN1326A1	JOINT RESISTANCE 71x19 G6.25	1.000	PCS																							
			RS0090A0	CIRC. HEAT. ELEMENT 1260W 220-230	1.000	PCS																							
VI1220A1	VIS AUTOTARADE UX 4.2x12 TCB MARUTEX PRE	3.000	PCS																										
VM1794A0	PLAQUETTE NOIRE 250X4.8 PA66	2.000	PCS																										
VM2103A0	PLAQUETTE FERMETURE COLLIER	2.000	PCS																										
KRS0050A	KIT RESISTANCE 0.5kW RS0050A	<table border="1"> <thead> <tr> <th>Code</th> <th>Description</th> <th>Qté</th> <th>UOM</th> </tr> </thead> <tbody> <tr> <td>GN1326A1</td> <td>JOINT RESISTANCE 71x19 G6.25</td> <td>1.000</td> <td>PCS</td> </tr> <tr> <td>RS0050A0</td> <td>HEAT. ELEMENT 500W 220-230V LIEV</td> <td>1.000</td> <td>PCS</td> </tr> <tr> <td>VI1220A1</td> <td>VIS AUTOTARADE UX 4.2x12 TCB MARUTEX PRE</td> <td>2.000</td> <td>PCS</td> </tr> </tbody> </table>	Code	Description	Qté	UOM	GN1326A1	JOINT RESISTANCE 71x19 G6.25	1.000	PCS	RS0050A0	HEAT. ELEMENT 500W 220-230V LIEV	1.000	PCS	VI1220A1	VIS AUTOTARADE UX 4.2x12 TCB MARUTEX PRE	2.000	PCS											
Code	Description	Qté	UOM																										
GN1326A1	JOINT RESISTANCE 71x19 G6.25	1.000	PCS																										
RS0050A0	HEAT. ELEMENT 500W 220-230V LIEV	1.000	PCS																										
VI1220A1	VIS AUTOTARADE UX 4.2x12 TCB MARUTEX PRE	2.000	PCS																										
KRS0011A	KIT RESISTANCE 1.465kW RS0011A	<table border="1"> <thead> <tr> <th>Code</th> <th>Description</th> <th>Qté</th> <th>UOM</th> </tr> </thead> <tbody> <tr> <td>GN1326A1</td> <td>JOINT RESISTANCE 71x19 G6.25</td> <td>1.000</td> <td>PCS</td> </tr> <tr> <td>RS0011A0</td> <td>CIRC.HEAT. ELEMENT 1465W 220-230</td> <td>1.000</td> <td>PCS</td> </tr> <tr> <td>VI1220A1</td> <td>VIS AUTOTARADE UX 4.2x12 TCB MARUTEX PRE</td> <td>3.000</td> <td>PCS</td> </tr> <tr> <td>VM1794A0</td> <td>PLAQUETTE NOIRE 250X4.8 PA66</td> <td>2.000</td> <td>PCS</td> </tr> <tr> <td>VM2103A0</td> <td>PLAQUETTE FERMETURE COLLIER</td> <td>2.000</td> <td>PCS</td> </tr> </tbody> </table>	Code	Description	Qté	UOM	GN1326A1	JOINT RESISTANCE 71x19 G6.25	1.000	PCS	RS0011A0	CIRC.HEAT. ELEMENT 1465W 220-230	1.000	PCS	VI1220A1	VIS AUTOTARADE UX 4.2x12 TCB MARUTEX PRE	3.000	PCS	VM1794A0	PLAQUETTE NOIRE 250X4.8 PA66	2.000	PCS	VM2103A0	PLAQUETTE FERMETURE COLLIER	2.000	PCS			
Code	Description	Qté	UOM																										
GN1326A1	JOINT RESISTANCE 71x19 G6.25	1.000	PCS																										
RS0011A0	CIRC.HEAT. ELEMENT 1465W 220-230	1.000	PCS																										
VI1220A1	VIS AUTOTARADE UX 4.2x12 TCB MARUTEX PRE	3.000	PCS																										
VM1794A0	PLAQUETTE NOIRE 250X4.8 PA66	2.000	PCS																										
VM2103A0	PLAQUETTE FERMETURE COLLIER	2.000	PCS																										
KRS0010A	KIT RESISTANCE RS0010A	<table border="1"> <thead> <tr> <th>Code</th> <th>Description</th> <th>Qté</th> <th>UOM</th> </tr> </thead> <tbody> <tr> <td>GN1326A1</td> <td>JOINT RESISTANCE 71x19 G6.25</td> <td>1.000</td> <td>PCS</td> </tr> </tbody> </table>	Code	Description	Qté	UOM	GN1326A1	JOINT RESISTANCE 71x19 G6.25	1.000	PCS																			
Code	Description	Qté	UOM																										
GN1326A1	JOINT RESISTANCE 71x19 G6.25	1.000	PCS																										

COMPOSANT			PIÈCE DE RECHANGE																														
Code	Description	Image	Code	Description	Composants du kit																												
GN1326A	JOINT RESISTANCE 71x19 G6.25		KRS0010A	KIT RESISTANCE RS0010A	<table border="1"> <thead> <tr> <th>Code</th> <th>Description</th> <th>Qté</th> <th>UOM</th> </tr> </thead> <tbody> <tr> <td>RS0010A0</td> <td>CIRC.HEAT. ELEMENT 2560W - 220-230 V</td> <td>1.000</td> <td>PCS</td> </tr> <tr> <td>VI1220A1</td> <td>VIS AUTOTARADE UX 4.2x12 TCB MARUTEX PRE</td> <td>3.000</td> <td>PCS</td> </tr> </tbody> </table>	Code	Description	Qté	UOM	RS0010A0	CIRC.HEAT. ELEMENT 2560W - 220-230 V	1.000	PCS	VI1220A1	VIS AUTOTARADE UX 4.2x12 TCB MARUTEX PRE	3.000	PCS																
			Code	Description	Qté	UOM																											
RS0010A0	CIRC.HEAT. ELEMENT 2560W - 220-230 V	1.000	PCS																														
VI1220A1	VIS AUTOTARADE UX 4.2x12 TCB MARUTEX PRE	3.000	PCS																														
KG1326A	KIT 5 PCS JOINT RESISTANCE GN136A1	<table border="1"> <thead> <tr> <th>Code</th> <th>Description</th> <th>Qté</th> <th>UOM</th> </tr> </thead> <tbody> <tr> <td>GN1326A1</td> <td>JOINT RESISTANCE 71x19 G6.25</td> <td>5.000</td> <td>PCS</td> </tr> </tbody> </table>	Code	Description	Qté	UOM	GN1326A1	JOINT RESISTANCE 71x19 G6.25	5.000	PCS																							
Code	Description	Qté	UOM																														
GN1326A1	JOINT RESISTANCE 71x19 G6.25	5.000	PCS																														
RS1215A	RES PLATE 147W 105V D230 1 SPIRE		KRS1034A	KIT RESISTANCE DE FREINAGE 147W MM	<table border="1"> <thead> <tr> <th>Code</th> <th>Description</th> <th>Qté</th> <th>UOM</th> </tr> </thead> <tbody> <tr> <td>GN1672A1</td> <td>JOINT RESISTANCE FREIN</td> <td>1.000</td> <td>PCS</td> </tr> <tr> <td>RS1034A0</td> <td>147W 105V 1 TURN FLAT ELEMENT</td> <td>1.000</td> <td>PCS</td> </tr> <tr> <td>SL1045A0</td> <td>SILICONE ANTHRACITE S57 sp-5007 80ml</td> <td>1.000</td> <td>PCS</td> </tr> <tr> <td>VI1220A1</td> <td>VIS AUTOTARADE UX 4.2x12 TCB MARUTEX PRE</td> <td>2.000</td> <td>PCS</td> </tr> </tbody> </table>	Code	Description	Qté	UOM	GN1672A1	JOINT RESISTANCE FREIN	1.000	PCS	RS1034A0	147W 105V 1 TURN FLAT ELEMENT	1.000	PCS	SL1045A0	SILICONE ANTHRACITE S57 sp-5007 80ml	1.000	PCS	VI1220A1	VIS AUTOTARADE UX 4.2x12 TCB MARUTEX PRE	2.000	PCS								
			Code	Description	Qté	UOM																											
			GN1672A1	JOINT RESISTANCE FREIN	1.000	PCS																											
			RS1034A0	147W 105V 1 TURN FLAT ELEMENT	1.000	PCS																											
SL1045A0	SILICONE ANTHRACITE S57 sp-5007 80ml	1.000	PCS																														
VI1220A1	VIS AUTOTARADE UX 4.2x12 TCB MARUTEX PRE	2.000	PCS																														
GN1285A	JOINT SONDE DE TEMPERATURE NTC		KTR1106B	KIT SONDE TEMP. CHAMBRE L2000 MIND.Maps	<table border="1"> <thead> <tr> <th>Code</th> <th>Description</th> <th>Qté</th> <th>UOM</th> </tr> </thead> <tbody> <tr> <td>GN1285A0</td> <td>JOINT SONDE DE TEMPERATUR E NTC</td> <td>1.000</td> <td>PCS</td> </tr> <tr> <td>SL1045A0</td> <td>SILICONE ANTHRACITE S57 sp-5007 80ml</td> <td>1.000</td> <td>PCS</td> </tr> <tr> <td>TR1106B0</td> <td>SONDE D'AMBIANCE PT100 L2000</td> <td>1.000</td> <td>PCS</td> </tr> <tr> <td>VI1220A1</td> <td>VIS AUTOTARADE UX 4.2x12 TCB MARUTEX PRE</td> <td>2.000</td> <td>PCS</td> </tr> <tr> <td>VM1464A1</td> <td>COUVERCLE SONDE D'AMB CT BT AVEC CLOISON</td> <td>1.000</td> <td>PCS</td> </tr> <tr> <td>VM1465A1</td> <td>COUVERCLE SONDE TEMPERATUR E CT BT</td> <td>1.000</td> <td>PCS</td> </tr> </tbody> </table>	Code	Description	Qté	UOM	GN1285A0	JOINT SONDE DE TEMPERATUR E NTC	1.000	PCS	SL1045A0	SILICONE ANTHRACITE S57 sp-5007 80ml	1.000	PCS	TR1106B0	SONDE D'AMBIANCE PT100 L2000	1.000	PCS	VI1220A1	VIS AUTOTARADE UX 4.2x12 TCB MARUTEX PRE	2.000	PCS	VM1464A1	COUVERCLE SONDE D'AMB CT BT AVEC CLOISON	1.000	PCS	VM1465A1	COUVERCLE SONDE TEMPERATUR E CT BT	1.000	PCS
Code	Description	Qté	UOM																														
GN1285A0	JOINT SONDE DE TEMPERATUR E NTC	1.000	PCS																														
SL1045A0	SILICONE ANTHRACITE S57 sp-5007 80ml	1.000	PCS																														
TR1106B0	SONDE D'AMBIANCE PT100 L2000	1.000	PCS																														
VI1220A1	VIS AUTOTARADE UX 4.2x12 TCB MARUTEX PRE	2.000	PCS																														
VM1464A1	COUVERCLE SONDE D'AMB CT BT AVEC CLOISON	1.000	PCS																														
VM1465A1	COUVERCLE SONDE TEMPERATUR E CT BT	1.000	PCS																														

COMPOSANT			PIÈCE DE RECHANGE																																							
Code	Description	Image	Code	Description	Composants du kit																																					
GN1285A	JOINT SONDE DE TEMPERATURE NTC		KTR1106A	KIT SONDE TEMP. CHAMBRE L2000 S.5-5E	<table border="1"> <thead> <tr> <th>Code</th> <th>Description</th> <th>Qté</th> <th>UOM</th> </tr> </thead> <tbody> <tr> <td>GN1285A0</td> <td>JOINT SONDE DE TEMPERATUR E NTC</td> <td>1.000</td> <td>PCS</td> </tr> <tr> <td>SL1045A0</td> <td>SILICONE ANTHRACITE S57 sp-5007 80ml</td> <td>1.000</td> <td>PCS</td> </tr> <tr> <td>TR1106A3</td> <td>SONDE D'AMBIANCE PT100 L2000</td> <td>1.000</td> <td>PCS</td> </tr> <tr> <td>VI1220A1</td> <td>VIS AUTOTARADE UX 4.2x12 TCB MARUTEX PRE</td> <td>2.000</td> <td>PCS</td> </tr> <tr> <td>VM1465A1</td> <td>COUVERCLE SONDE TEMPERATUR E CT BT</td> <td>1.000</td> <td>PCS</td> </tr> </tbody> </table>	Code	Description	Qté	UOM	GN1285A0	JOINT SONDE DE TEMPERATUR E NTC	1.000	PCS	SL1045A0	SILICONE ANTHRACITE S57 sp-5007 80ml	1.000	PCS	TR1106A3	SONDE D'AMBIANCE PT100 L2000	1.000	PCS	VI1220A1	VIS AUTOTARADE UX 4.2x12 TCB MARUTEX PRE	2.000	PCS	VM1465A1	COUVERCLE SONDE TEMPERATUR E CT BT	1.000	PCS													
			Code	Description	Qté	UOM																																				
GN1285A0	JOINT SONDE DE TEMPERATUR E NTC	1.000	PCS																																							
SL1045A0	SILICONE ANTHRACITE S57 sp-5007 80ml	1.000	PCS																																							
TR1106A3	SONDE D'AMBIANCE PT100 L2000	1.000	PCS																																							
VI1220A1	VIS AUTOTARADE UX 4.2x12 TCB MARUTEX PRE	2.000	PCS																																							
VM1465A1	COUVERCLE SONDE TEMPERATUR E CT BT	1.000	PCS																																							
KTR1105A	KIT SONDE DE TEMPERATURE PT100 L1000	<table border="1"> <thead> <tr> <th>Code</th> <th>Description</th> <th>Qté</th> <th>UOM</th> </tr> </thead> <tbody> <tr> <td>0H4302A0</td> <td>PLAQUE SILICONE POUR SONDE</td> <td>1.000</td> <td>PCS</td> </tr> <tr> <td>GN1120A1</td> <td>JOINT SONDE D'AMBIANCE NTC LM</td> <td>1.000</td> <td>PCS</td> </tr> <tr> <td>GN1285A0</td> <td>JOINT SONDE DE TEMPERATUR E NTC</td> <td>1.000</td> <td>PCS</td> </tr> <tr> <td>SL1045A0</td> <td>SILICONE ANTHRACITE S57 sp-5007 80ml</td> <td>1.000</td> <td>PCS</td> </tr> <tr> <td>TR1105A4</td> <td>SONDE D'AMBIANCE PT100 L1000</td> <td>1.000</td> <td>PCS</td> </tr> <tr> <td>VI1220A1</td> <td>VIS AUTOTARADE UX 4.2x12 TCB MARUTEX PRE</td> <td>2.000</td> <td>PCS</td> </tr> <tr> <td>VM1464A1</td> <td>COUVERCLE SONDE D'AMB CT BT AVEC CLOISON</td> <td>1.000</td> <td>PCS</td> </tr> <tr> <td>VM1465A1</td> <td>COUVERCLE SONDE TEMPERATUR E CT BT</td> <td>1.000</td> <td>PCS</td> </tr> <tr> <td>VM2052A0</td> <td>COUVERCLE SONDE TEMPERATUR E LM</td> <td>1.000</td> <td>PCS</td> </tr> </tbody> </table>	Code	Description	Qté	UOM	0H4302A0	PLAQUE SILICONE POUR SONDE	1.000	PCS	GN1120A1	JOINT SONDE D'AMBIANCE NTC LM	1.000	PCS	GN1285A0	JOINT SONDE DE TEMPERATUR E NTC	1.000	PCS	SL1045A0	SILICONE ANTHRACITE S57 sp-5007 80ml	1.000	PCS	TR1105A4	SONDE D'AMBIANCE PT100 L1000	1.000	PCS	VI1220A1	VIS AUTOTARADE UX 4.2x12 TCB MARUTEX PRE	2.000	PCS	VM1464A1	COUVERCLE SONDE D'AMB CT BT AVEC CLOISON	1.000	PCS	VM1465A1	COUVERCLE SONDE TEMPERATUR E CT BT	1.000	PCS	VM2052A0	COUVERCLE SONDE TEMPERATUR E LM	1.000	PCS
Code	Description	Qté	UOM																																							
0H4302A0	PLAQUE SILICONE POUR SONDE	1.000	PCS																																							
GN1120A1	JOINT SONDE D'AMBIANCE NTC LM	1.000	PCS																																							
GN1285A0	JOINT SONDE DE TEMPERATUR E NTC	1.000	PCS																																							
SL1045A0	SILICONE ANTHRACITE S57 sp-5007 80ml	1.000	PCS																																							
TR1105A4	SONDE D'AMBIANCE PT100 L1000	1.000	PCS																																							
VI1220A1	VIS AUTOTARADE UX 4.2x12 TCB MARUTEX PRE	2.000	PCS																																							
VM1464A1	COUVERCLE SONDE D'AMB CT BT AVEC CLOISON	1.000	PCS																																							
VM1465A1	COUVERCLE SONDE TEMPERATUR E CT BT	1.000	PCS																																							
VM2052A0	COUVERCLE SONDE TEMPERATUR E LM	1.000	PCS																																							



COMPOSANT			PIÈCE DE RECHANGE																														
Code	Description	Image	Code	Description	Composants du kit																												
GN1285A	JOINT SONDE DE TEMPERATURE NTC		KTR1096A	KIT SONDE TEMPERATURE NTC 150 L=1500	<table border="1"> <thead> <tr> <th>Code</th> <th>Description</th> <th>Qté</th> <th>UOM</th> </tr> </thead> <tbody> <tr> <td>GN1120A1</td> <td>JOINT SONDE D'AMBIANCE NTC LM</td> <td>1.000</td> <td>PCS</td> </tr> <tr> <td>GN1285A0</td> <td>JOINT SONDE DE TEMPERATUR E NTC</td> <td>2.000</td> <td>PCS</td> </tr> <tr> <td>SL1045A0</td> <td>SILICONE ANTHRACITE S57 sp-5007 80ml</td> <td>1.000</td> <td>PCS</td> </tr> <tr> <td>TR1096A0</td> <td>TEMPERATUR E PROBE NTC 150 L=1500</td> <td>1.000</td> <td>PCS</td> </tr> <tr> <td>VI1220A1</td> <td>VIS AUTOTARADE UX 4.2x12 TCB MARUTEX PRE</td> <td>2.000</td> <td>PCS</td> </tr> <tr> <td>VM1465A1</td> <td>COUVERCLE SONDE TEMPERATUR E CT BT</td> <td>1.000</td> <td>PCS</td> </tr> </tbody> </table>	Code	Description	Qté	UOM	GN1120A1	JOINT SONDE D'AMBIANCE NTC LM	1.000	PCS	GN1285A0	JOINT SONDE DE TEMPERATUR E NTC	2.000	PCS	SL1045A0	SILICONE ANTHRACITE S57 sp-5007 80ml	1.000	PCS	TR1096A0	TEMPERATUR E PROBE NTC 150 L=1500	1.000	PCS	VI1220A1	VIS AUTOTARADE UX 4.2x12 TCB MARUTEX PRE	2.000	PCS	VM1465A1	COUVERCLE SONDE TEMPERATUR E CT BT	1.000	PCS
			Code	Description	Qté	UOM																											
			GN1120A1	JOINT SONDE D'AMBIANCE NTC LM	1.000	PCS																											
GN1285A0	JOINT SONDE DE TEMPERATUR E NTC	2.000	PCS																														
SL1045A0	SILICONE ANTHRACITE S57 sp-5007 80ml	1.000	PCS																														
TR1096A0	TEMPERATUR E PROBE NTC 150 L=1500	1.000	PCS																														
VI1220A1	VIS AUTOTARADE UX 4.2x12 TCB MARUTEX PRE	2.000	PCS																														
VM1465A1	COUVERCLE SONDE TEMPERATUR E CT BT	1.000	PCS																														
KTR1095A	KIT SONDE TEMPERATURE NTC 150 L=1050	<table border="1"> <thead> <tr> <th>Code</th> <th>Description</th> <th>Qté</th> <th>UOM</th> </tr> </thead> <tbody> <tr> <td>GN1120A1</td> <td>JOINT SONDE D'AMBIANCE NTC LM</td> <td>1.000</td> <td>PCS</td> </tr> <tr> <td>GN1285A0</td> <td>JOINT SONDE DE TEMPERATUR E NTC</td> <td>1.000</td> <td>PCS</td> </tr> <tr> <td>SL1045A0</td> <td>SILICONE ANTHRACITE S57 sp-5007 80ml</td> <td>1.000</td> <td>PCS</td> </tr> <tr> <td>TR1095A0</td> <td>TEMPERATUR E PROBE NTC 150 L=1050</td> <td>1.000</td> <td>PCS</td> </tr> <tr> <td>VI1220A1</td> <td>VIS AUTOTARADE UX 4.2x12 TCB MARUTEX PRE</td> <td>2.000</td> <td>PCS</td> </tr> <tr> <td>VM1465A1</td> <td>COUVERCLE SONDE TEMPERATUR E CT BT</td> <td>1.000</td> <td>PCS</td> </tr> </tbody> </table>	Code	Description	Qté	UOM	GN1120A1	JOINT SONDE D'AMBIANCE NTC LM	1.000	PCS	GN1285A0	JOINT SONDE DE TEMPERATUR E NTC	1.000	PCS	SL1045A0	SILICONE ANTHRACITE S57 sp-5007 80ml	1.000	PCS	TR1095A0	TEMPERATUR E PROBE NTC 150 L=1050	1.000	PCS	VI1220A1	VIS AUTOTARADE UX 4.2x12 TCB MARUTEX PRE	2.000	PCS	VM1465A1	COUVERCLE SONDE TEMPERATUR E CT BT	1.000	PCS			
Code	Description	Qté	UOM																														
GN1120A1	JOINT SONDE D'AMBIANCE NTC LM	1.000	PCS																														
GN1285A0	JOINT SONDE DE TEMPERATUR E NTC	1.000	PCS																														
SL1045A0	SILICONE ANTHRACITE S57 sp-5007 80ml	1.000	PCS																														
TR1095A0	TEMPERATUR E PROBE NTC 150 L=1050	1.000	PCS																														
VI1220A1	VIS AUTOTARADE UX 4.2x12 TCB MARUTEX PRE	2.000	PCS																														
VM1465A1	COUVERCLE SONDE TEMPERATUR E CT BT	1.000	PCS																														
KTR1002A	KIT SONDE TEMPERATURE UL PT100 L1000	<table border="1"> <thead> <tr> <th>Code</th> <th>Description</th> <th>Qté</th> <th>UOM</th> </tr> </thead> <tbody> <tr> <td>GN1285A0</td> <td>JOINT SONDE DE TEMPERATUR E NTC</td> <td>2.000</td> <td>PCS</td> </tr> </tbody> </table>	Code	Description	Qté	UOM	GN1285A0	JOINT SONDE DE TEMPERATUR E NTC	2.000	PCS																							
Code	Description	Qté	UOM																														
GN1285A0	JOINT SONDE DE TEMPERATUR E NTC	2.000	PCS																														

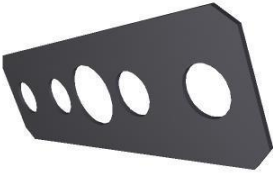

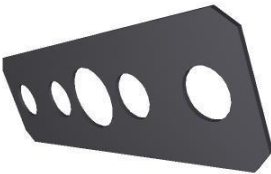
COMPOSANT			PIÈCE DE RECHANGE																														
Code	Description	Image	Code	Description	Composants du kit																												
GN1285A	JOINT SONDE DE TEMPERATURE NTC		KTR1002A	KIT SONDE TEMPERATURE UL PT100 L1000	<table border="1"> <thead> <tr> <th>Code</th> <th>Description</th> <th>Qté</th> <th>UOM</th> </tr> </thead> <tbody> <tr> <td>SL1045A0</td> <td>SILICONE ANTHRACITE S57 sp-5007 80ml</td> <td>1.000</td> <td>PCS</td> </tr> <tr> <td>TR1002A1</td> <td></td> <td>1.000</td> <td>PCS</td> </tr> <tr> <td>VI1220A1</td> <td>VIS AUTOTARADE UX 4.2x12 TCB MARUTEX PRE</td> <td>2.000</td> <td>PCS</td> </tr> <tr> <td>VM1465A1</td> <td>COUVERCLE SONDE TEMPERATUR E CT BT</td> <td>1.000</td> <td>PCS</td> </tr> </tbody> </table>	Code	Description	Qté	UOM	SL1045A0	SILICONE ANTHRACITE S57 sp-5007 80ml	1.000	PCS	TR1002A1		1.000	PCS	VI1220A1	VIS AUTOTARADE UX 4.2x12 TCB MARUTEX PRE	2.000	PCS	VM1465A1	COUVERCLE SONDE TEMPERATUR E CT BT	1.000	PCS								
Code	Description	Qté	UOM																														
SL1045A0	SILICONE ANTHRACITE S57 sp-5007 80ml	1.000	PCS																														
TR1002A1		1.000	PCS																														
VI1220A1	VIS AUTOTARADE UX 4.2x12 TCB MARUTEX PRE	2.000	PCS																														
VM1465A1	COUVERCLE SONDE TEMPERATUR E CT BT	1.000	PCS																														
TR1106B	SONDE D'AMBIANCE PT100 L2000		KTR1106B	KIT SONDE TEMP. CHAMBRE L2000 MIND.Maps	<table border="1"> <thead> <tr> <th>Code</th> <th>Description</th> <th>Qté</th> <th>UOM</th> </tr> </thead> <tbody> <tr> <td>GN1285A0</td> <td>JOINT SONDE DE TEMPERATUR E NTC</td> <td>1.000</td> <td>PCS</td> </tr> <tr> <td>SL1045A0</td> <td>SILICONE ANTHRACITE S57 sp-5007 80ml</td> <td>1.000</td> <td>PCS</td> </tr> <tr> <td>TR1106B0</td> <td>SONDE D'AMBIANCE PT100 L2000</td> <td>1.000</td> <td>PCS</td> </tr> <tr> <td>VI1220A1</td> <td>VIS AUTOTARADE UX 4.2x12 TCB MARUTEX PRE</td> <td>2.000</td> <td>PCS</td> </tr> <tr> <td>VM1464A1</td> <td>COUVERCLE SONDE D'AMB CT BT AVEC CLOISON</td> <td>1.000</td> <td>PCS</td> </tr> <tr> <td>VM1465A1</td> <td>COUVERCLE SONDE TEMPERATUR E CT BT</td> <td>1.000</td> <td>PCS</td> </tr> </tbody> </table>	Code	Description	Qté	UOM	GN1285A0	JOINT SONDE DE TEMPERATUR E NTC	1.000	PCS	SL1045A0	SILICONE ANTHRACITE S57 sp-5007 80ml	1.000	PCS	TR1106B0	SONDE D'AMBIANCE PT100 L2000	1.000	PCS	VI1220A1	VIS AUTOTARADE UX 4.2x12 TCB MARUTEX PRE	2.000	PCS	VM1464A1	COUVERCLE SONDE D'AMB CT BT AVEC CLOISON	1.000	PCS	VM1465A1	COUVERCLE SONDE TEMPERATUR E CT BT	1.000	PCS
Code	Description	Qté	UOM																														
GN1285A0	JOINT SONDE DE TEMPERATUR E NTC	1.000	PCS																														
SL1045A0	SILICONE ANTHRACITE S57 sp-5007 80ml	1.000	PCS																														
TR1106B0	SONDE D'AMBIANCE PT100 L2000	1.000	PCS																														
VI1220A1	VIS AUTOTARADE UX 4.2x12 TCB MARUTEX PRE	2.000	PCS																														
VM1464A1	COUVERCLE SONDE D'AMB CT BT AVEC CLOISON	1.000	PCS																														
VM1465A1	COUVERCLE SONDE TEMPERATUR E CT BT	1.000	PCS																														
VM1464A	COUVERCLE SONDE D'AMB CT BT AVEC CLOISON		KVM1464A	KIT COUVERCLE SONDE TEMP CT BT VM1464A0	<table border="1"> <thead> <tr> <th>Code</th> <th>Description</th> <th>Qté</th> <th>UOM</th> </tr> </thead> <tbody> <tr> <td>VM1464A1</td> <td>COUVERCLE SONDE D'AMB CT BT AVEC CLOISON</td> <td>1.000</td> <td>PCS</td> </tr> </tbody> </table>	Code	Description	Qté	UOM	VM1464A1	COUVERCLE SONDE D'AMB CT BT AVEC CLOISON	1.000	PCS																				
Code	Description	Qté	UOM																														
VM1464A1	COUVERCLE SONDE D'AMB CT BT AVEC CLOISON	1.000	PCS																														

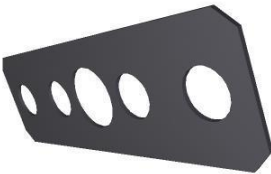
COMPOSANT			PIÈCE DE RECHANGE																										
Code	Description	Image	Code	Description	Composants du kit																								
0H7030A	COUVERCLE ENTREE AMPOULE		K0H7030A	KIT COUVERCLE ENTREE BULBE	<table border="1"> <thead> <tr> <th>Code</th> <th>Description</th> <th>Qté</th> <th>UOM</th> </tr> </thead> <tbody> <tr> <td>0H8120A0</td> <td>COUVERCLE ENTREE AMPOULE XEV</td> <td>1.000</td> <td>PCS</td> </tr> </tbody> </table>	Code	Description	Qté	UOM	0H8120A0	COUVERCLE ENTREE AMPOULE XEV	1.000	PCS																
Code	Description	Qté	UOM																										
0H8120A0	COUVERCLE ENTREE AMPOULE XEV	1.000	PCS																										
GN1531A	JOINT D'ETANCHEITE ENTREE BULBE		KTR1136A	KIT THERMOSTAT DE SECURITE 318°C -0/+24	<table border="1"> <thead> <tr> <th>Code</th> <th>Description</th> <th>Qté</th> <th>UOM</th> </tr> </thead> <tbody> <tr> <td>0H8120A0</td> <td>COUVERCLE ENTREE AMPOULE XEV</td> <td>1.000</td> <td>PCS</td> </tr> <tr> <td>GN1531A0</td> <td>JOINT D'ETANCHEIT E ENTREE BULBE</td> <td>1.000</td> <td>PCS</td> </tr> <tr> <td>SL1045A0</td> <td>SILICONE ANTHRACITE S57 sp-5007 80ml</td> <td>1.000</td> <td>PCS</td> </tr> <tr> <td>TR1136A0</td> <td>THERMOSTAT DE SECURITE 318°C -0/+24</td> <td>1.000</td> <td>PCS</td> </tr> <tr> <td>VI1220A1</td> <td>VIS AUTOTARADE UX 4.2x12 TCB MARUTEX PRE</td> <td>3.000</td> <td>PCS</td> </tr> </tbody> </table>	Code	Description	Qté	UOM	0H8120A0	COUVERCLE ENTREE AMPOULE XEV	1.000	PCS	GN1531A0	JOINT D'ETANCHEIT E ENTREE BULBE	1.000	PCS	SL1045A0	SILICONE ANTHRACITE S57 sp-5007 80ml	1.000	PCS	TR1136A0	THERMOSTAT DE SECURITE 318°C -0/+24	1.000	PCS	VI1220A1	VIS AUTOTARADE UX 4.2x12 TCB MARUTEX PRE	3.000	PCS
Code	Description	Qté	UOM																										
0H8120A0	COUVERCLE ENTREE AMPOULE XEV	1.000	PCS																										
GN1531A0	JOINT D'ETANCHEIT E ENTREE BULBE	1.000	PCS																										
SL1045A0	SILICONE ANTHRACITE S57 sp-5007 80ml	1.000	PCS																										
TR1136A0	THERMOSTAT DE SECURITE 318°C -0/+24	1.000	PCS																										
VI1220A1	VIS AUTOTARADE UX 4.2x12 TCB MARUTEX PRE	3.000	PCS																										
GN1326A	JOINT RESISTANCE 71x19 G6.25		KRS1274A	KIT RESISTANCE DE FRAINAGE 100W	<table border="1"> <thead> <tr> <th>Code</th> <th>Description</th> <th>Qté</th> <th>UOM</th> </tr> </thead> <tbody> <tr> <td>GN1672A1</td> <td>JOINT RESISTANCE FREIN</td> <td>1.000</td> <td>PCS</td> </tr> <tr> <td>RS1274A0</td> <td>RESISTANCE PLATE 100W 60V 1 TOUR</td> <td>1.000</td> <td>PCS</td> </tr> <tr> <td>SL1045A0</td> <td>SILICONE ANTHRACITE S57 sp-5007 80ml</td> <td>1.000</td> <td>PCS</td> </tr> <tr> <td>VI1220A1</td> <td>VIS AUTOTARADE UX 4.2x12 TCB MARUTEX PRE</td> <td>2.000</td> <td>PCS</td> </tr> </tbody> </table>	Code	Description	Qté	UOM	GN1672A1	JOINT RESISTANCE FREIN	1.000	PCS	RS1274A0	RESISTANCE PLATE 100W 60V 1 TOUR	1.000	PCS	SL1045A0	SILICONE ANTHRACITE S57 sp-5007 80ml	1.000	PCS	VI1220A1	VIS AUTOTARADE UX 4.2x12 TCB MARUTEX PRE	2.000	PCS				
Code	Description	Qté	UOM																										
GN1672A1	JOINT RESISTANCE FREIN	1.000	PCS																										
RS1274A0	RESISTANCE PLATE 100W 60V 1 TOUR	1.000	PCS																										
SL1045A0	SILICONE ANTHRACITE S57 sp-5007 80ml	1.000	PCS																										
VI1220A1	VIS AUTOTARADE UX 4.2x12 TCB MARUTEX PRE	2.000	PCS																										
			KRS1261A	KIT RESISTANCE DE FREINAGE 122W	<table border="1"> <thead> <tr> <th>Code</th> <th>Description</th> <th>Qté</th> <th>UOM</th> </tr> </thead> <tbody> <tr> <td>GN1326A1</td> <td>JOINT RESISTANCE 71x19 G6.25</td> <td>1.000</td> <td>PCS</td> </tr> <tr> <td>RS1261A0</td> <td>RESISTANCE MOTEUR BAKERLUXCH EFLUX</td> <td>1.000</td> <td>PCS</td> </tr> </tbody> </table>	Code	Description	Qté	UOM	GN1326A1	JOINT RESISTANCE 71x19 G6.25	1.000	PCS	RS1261A0	RESISTANCE MOTEUR BAKERLUXCH EFLUX	1.000	PCS												
Code	Description	Qté	UOM																										
GN1326A1	JOINT RESISTANCE 71x19 G6.25	1.000	PCS																										
RS1261A0	RESISTANCE MOTEUR BAKERLUXCH EFLUX	1.000	PCS																										

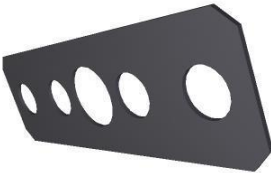
COMPOSANT			PIÈCE DE RECHANGE																			
Code	Description	Image	Code	Description	Composants du kit																	
GN1326A	JOINT RESISTANCE 71x19 G6.25		KRS1261A	KIT RESISTANCE DE FREINAGE 122W	<table border="1"> <thead> <tr> <th>Code</th> <th>Description</th> <th>Qté</th> <th>UOM</th> </tr> </thead> <tbody> <tr> <td>SL1045A0</td> <td>SILICONE ANTHRACITE S57 sp-5007 80ml</td> <td>1.000</td> <td>PCS</td> </tr> <tr> <td>VI1220A1</td> <td>VIS AUTOTARADE UX 4.2x12 TCB MARUTEX PRE</td> <td>2.000</td> <td>PCS</td> </tr> </tbody> </table>	Code	Description	Qté	UOM	SL1045A0	SILICONE ANTHRACITE S57 sp-5007 80ml	1.000	PCS	VI1220A1	VIS AUTOTARADE UX 4.2x12 TCB MARUTEX PRE	2.000	PCS					
			Code	Description	Qté	UOM																
			SL1045A0	SILICONE ANTHRACITE S57 sp-5007 80ml	1.000	PCS																
			VI1220A1	VIS AUTOTARADE UX 4.2x12 TCB MARUTEX PRE	2.000	PCS																
KRS1215A	KIT RESISTANCE DE FRAINAGE 147W	<table border="1"> <thead> <tr> <th>Code</th> <th>Description</th> <th>Qté</th> <th>UOM</th> </tr> </thead> <tbody> <tr> <td>GN1672A1</td> <td>JOINT RESISTANCE FREIN</td> <td>1.000</td> <td>PCS</td> </tr> <tr> <td>RS1215A1</td> <td>RES PLATE 147W 105V D230 1 SPIRE</td> <td>1.000</td> <td>PCS</td> </tr> <tr> <td>SL1045A0</td> <td>SILICONE ANTHRACITE S57 sp-5007 80ml</td> <td>1.000</td> <td>PCS</td> </tr> <tr> <td>VI1220A1</td> <td>VIS AUTOTARADE UX 4.2x12 TCB MARUTEX PRE</td> <td>2.000</td> <td>PCS</td> </tr> </tbody> </table>	Code	Description	Qté	UOM	GN1672A1	JOINT RESISTANCE FREIN	1.000	PCS	RS1215A1	RES PLATE 147W 105V D230 1 SPIRE	1.000	PCS	SL1045A0	SILICONE ANTHRACITE S57 sp-5007 80ml	1.000	PCS	VI1220A1	VIS AUTOTARADE UX 4.2x12 TCB MARUTEX PRE	2.000	PCS
Code	Description	Qté	UOM																			
GN1672A1	JOINT RESISTANCE FREIN	1.000	PCS																			
RS1215A1	RES PLATE 147W 105V D230 1 SPIRE	1.000	PCS																			
SL1045A0	SILICONE ANTHRACITE S57 sp-5007 80ml	1.000	PCS																			
VI1220A1	VIS AUTOTARADE UX 4.2x12 TCB MARUTEX PRE	2.000	PCS																			
KRS1095A	KIT RESISTANCE 1.2kW	<table border="1"> <thead> <tr> <th>Code</th> <th>Description</th> <th>Qté</th> <th>UOM</th> </tr> </thead> <tbody> <tr> <td>GN1326A1</td> <td>JOINT RESISTANCE 71x19 G6.25</td> <td>1.000</td> <td>PCS</td> </tr> <tr> <td>RS1095A1</td> <td>HEATING ELEMENT 1200W 230V</td> <td>1.000</td> <td>PCS</td> </tr> <tr> <td>SL1045A0</td> <td>SILICONE ANTHRACITE S57 sp-5007 80ml</td> <td>1.000</td> <td>PCS</td> </tr> <tr> <td>VI1220A1</td> <td>VIS AUTOTARADE UX 4.2x12 TCB MARUTEX PRE</td> <td>2.000</td> <td>PCS</td> </tr> </tbody> </table>	Code	Description	Qté	UOM	GN1326A1	JOINT RESISTANCE 71x19 G6.25	1.000	PCS	RS1095A1	HEATING ELEMENT 1200W 230V	1.000	PCS	SL1045A0	SILICONE ANTHRACITE S57 sp-5007 80ml	1.000	PCS	VI1220A1	VIS AUTOTARADE UX 4.2x12 TCB MARUTEX PRE	2.000	PCS
Code	Description	Qté	UOM																			
GN1326A1	JOINT RESISTANCE 71x19 G6.25	1.000	PCS																			
RS1095A1	HEATING ELEMENT 1200W 230V	1.000	PCS																			
SL1045A0	SILICONE ANTHRACITE S57 sp-5007 80ml	1.000	PCS																			
VI1220A1	VIS AUTOTARADE UX 4.2x12 TCB MARUTEX PRE	2.000	PCS																			
KRS1012A	KIT RESISTANCE 1365W 120V	<table border="1"> <thead> <tr> <th>Code</th> <th>Description</th> <th>Qté</th> <th>UOM</th> </tr> </thead> <tbody> <tr> <td>GN1326A1</td> <td>JOINT RESISTANCE 71x19 G6.25</td> <td>1.000</td> <td>PCS</td> </tr> <tr> <td>RS1012A0</td> <td>CIRCULAR ELEMENT 1365W 120V</td> <td>1.000</td> <td>PCS</td> </tr> <tr> <td>VI1220A1</td> <td>VIS AUTOTARADE UX 4.2x12 TCB MARUTEX PRE</td> <td>5.000</td> <td>PCS</td> </tr> </tbody> </table>	Code	Description	Qté	UOM	GN1326A1	JOINT RESISTANCE 71x19 G6.25	1.000	PCS	RS1012A0	CIRCULAR ELEMENT 1365W 120V	1.000	PCS	VI1220A1	VIS AUTOTARADE UX 4.2x12 TCB MARUTEX PRE	5.000	PCS				
Code	Description	Qté	UOM																			
GN1326A1	JOINT RESISTANCE 71x19 G6.25	1.000	PCS																			
RS1012A0	CIRCULAR ELEMENT 1365W 120V	1.000	PCS																			
VI1220A1	VIS AUTOTARADE UX 4.2x12 TCB MARUTEX PRE	5.000	PCS																			

COMPOSANT			PIÈCE DE RECHANGE																							
Code	Description	Image	Code	Description	Composants du kit																					
GN1326A	JOINT RESISTANCE 71x19 G6.25		KRS1011A	KIT RESISTANCE ROBERTA/LISA	<table border="1"> <thead> <tr> <th>Code</th> <th>Description</th> <th>Qté</th> <th>UOM</th> </tr> </thead> <tbody> <tr> <td>GN1326A1</td> <td>JOINT RESISTANCE 71x19 G6.25</td> <td>1.000</td> <td>PCS</td> </tr> <tr> <td>RS1011A0</td> <td>RESISTENCE CIRCULAIRE 2560W 220-230</td> <td>1.000</td> <td>PCS</td> </tr> <tr> <td>SL1045A0</td> <td>SILICONE ANTHRACITE S57 sp-5007 80ml</td> <td>1.000</td> <td>PCS</td> </tr> <tr> <td>VI1220A1</td> <td>VIS AUTOTARADE UX 4.2x12 TCB MARUTEX PRE</td> <td>5.000</td> <td>PCS</td> </tr> </tbody> </table>	Code	Description	Qté	UOM	GN1326A1	JOINT RESISTANCE 71x19 G6.25	1.000	PCS	RS1011A0	RESISTENCE CIRCULAIRE 2560W 220-230	1.000	PCS	SL1045A0	SILICONE ANTHRACITE S57 sp-5007 80ml	1.000	PCS	VI1220A1	VIS AUTOTARADE UX 4.2x12 TCB MARUTEX PRE	5.000	PCS	
			Code	Description	Qté	UOM																				
			GN1326A1	JOINT RESISTANCE 71x19 G6.25	1.000	PCS																				
			RS1011A0	RESISTENCE CIRCULAIRE 2560W 220-230	1.000	PCS																				
SL1045A0	SILICONE ANTHRACITE S57 sp-5007 80ml	1.000	PCS																							
VI1220A1	VIS AUTOTARADE UX 4.2x12 TCB MARUTEX PRE	5.000	PCS																							
KRS0090A	KIT RESISTANCE 1.26kW RS0090A	<table border="1"> <thead> <tr> <th>Code</th> <th>Description</th> <th>Qté</th> <th>UOM</th> </tr> </thead> <tbody> <tr> <td>GN1326A1</td> <td>JOINT RESISTANCE 71x19 G6.25</td> <td>1.000</td> <td>PCS</td> </tr> <tr> <td>RS0090A0</td> <td>CIRC. HEAT. ELEMENT 1260W 220-230</td> <td>1.000</td> <td>PCS</td> </tr> <tr> <td>VI1220A1</td> <td>VIS AUTOTARADE UX 4.2x12 TCB MARUTEX PRE</td> <td>3.000</td> <td>PCS</td> </tr> <tr> <td>VM1794A0</td> <td>PLAQUETTE NOIRE 250X4.8 PA66</td> <td>2.000</td> <td>PCS</td> </tr> <tr> <td>VM2103A0</td> <td>PLAQUETTE FERMETURE COLLIER</td> <td>2.000</td> <td>PCS</td> </tr> </tbody> </table>	Code	Description	Qté	UOM	GN1326A1	JOINT RESISTANCE 71x19 G6.25	1.000	PCS	RS0090A0	CIRC. HEAT. ELEMENT 1260W 220-230	1.000	PCS	VI1220A1	VIS AUTOTARADE UX 4.2x12 TCB MARUTEX PRE	3.000	PCS	VM1794A0	PLAQUETTE NOIRE 250X4.8 PA66	2.000	PCS	VM2103A0	PLAQUETTE FERMETURE COLLIER	2.000	PCS
Code	Description	Qté	UOM																							
GN1326A1	JOINT RESISTANCE 71x19 G6.25	1.000	PCS																							
RS0090A0	CIRC. HEAT. ELEMENT 1260W 220-230	1.000	PCS																							
VI1220A1	VIS AUTOTARADE UX 4.2x12 TCB MARUTEX PRE	3.000	PCS																							
VM1794A0	PLAQUETTE NOIRE 250X4.8 PA66	2.000	PCS																							
VM2103A0	PLAQUETTE FERMETURE COLLIER	2.000	PCS																							
KRS0050A	KIT RESISTANCE 0.5kW RS0050A	<table border="1"> <thead> <tr> <th>Code</th> <th>Description</th> <th>Qté</th> <th>UOM</th> </tr> </thead> <tbody> <tr> <td>GN1326A1</td> <td>JOINT RESISTANCE 71x19 G6.25</td> <td>1.000</td> <td>PCS</td> </tr> <tr> <td>RS0050A0</td> <td>HEAT. ELEMENT 500W 220-230V LIEV</td> <td>1.000</td> <td>PCS</td> </tr> <tr> <td>VI1220A1</td> <td>VIS AUTOTARADE UX 4.2x12 TCB MARUTEX PRE</td> <td>2.000</td> <td>PCS</td> </tr> </tbody> </table>	Code	Description	Qté	UOM	GN1326A1	JOINT RESISTANCE 71x19 G6.25	1.000	PCS	RS0050A0	HEAT. ELEMENT 500W 220-230V LIEV	1.000	PCS	VI1220A1	VIS AUTOTARADE UX 4.2x12 TCB MARUTEX PRE	2.000	PCS								
Code	Description	Qté	UOM																							
GN1326A1	JOINT RESISTANCE 71x19 G6.25	1.000	PCS																							
RS0050A0	HEAT. ELEMENT 500W 220-230V LIEV	1.000	PCS																							
VI1220A1	VIS AUTOTARADE UX 4.2x12 TCB MARUTEX PRE	2.000	PCS																							
KRS0011A	KIT RESISTANCE 1.465kW RS0011A	<table border="1"> <thead> <tr> <th>Code</th> <th>Description</th> <th>Qté</th> <th>UOM</th> </tr> </thead> <tbody> <tr> <td>GN1326A1</td> <td>JOINT RESISTANCE 71x19 G6.25</td> <td>1.000</td> <td>PCS</td> </tr> <tr> <td>RS0011A0</td> <td>CIRC.HEAT. ELEMENT 1465W 220-230</td> <td>1.000</td> <td>PCS</td> </tr> </tbody> </table>	Code	Description	Qté	UOM	GN1326A1	JOINT RESISTANCE 71x19 G6.25	1.000	PCS	RS0011A0	CIRC.HEAT. ELEMENT 1465W 220-230	1.000	PCS												
Code	Description	Qté	UOM																							
GN1326A1	JOINT RESISTANCE 71x19 G6.25	1.000	PCS																							
RS0011A0	CIRC.HEAT. ELEMENT 1465W 220-230	1.000	PCS																							

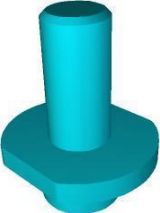

COMPOSANT			PIÈCE DE RECHANGE																						
Code	Description	Image	Code	Description	Composants du kit																				
GN1326A	JOINT RESISTANCE 71x19 G6.25		KRS0011A	KIT RESISTANCE 1.465kW RS0011A	<table border="1"> <thead> <tr> <th>Code</th> <th>Description</th> <th>Qté</th> <th>UOM</th> </tr> </thead> <tbody> <tr> <td>VI1220A1</td> <td>VIS AUTOTARADE UX 4.2x12 TCB MARUTEX PRE</td> <td>3.000</td> <td>PCS</td> </tr> <tr> <td>VM1794A0</td> <td>PLAQUETTE NOIRE 250X4.8 PA66</td> <td>2.000</td> <td>PCS</td> </tr> <tr> <td>VM2103A0</td> <td>PLAQUETTE FERMETURE COLLIER</td> <td>2.000</td> <td>PCS</td> </tr> </tbody> </table>	Code	Description	Qté	UOM	VI1220A1	VIS AUTOTARADE UX 4.2x12 TCB MARUTEX PRE	3.000	PCS	VM1794A0	PLAQUETTE NOIRE 250X4.8 PA66	2.000	PCS	VM2103A0	PLAQUETTE FERMETURE COLLIER	2.000	PCS				
			Code	Description	Qté	UOM																			
			VI1220A1	VIS AUTOTARADE UX 4.2x12 TCB MARUTEX PRE	3.000	PCS																			
VM1794A0	PLAQUETTE NOIRE 250X4.8 PA66	2.000	PCS																						
VM2103A0	PLAQUETTE FERMETURE COLLIER	2.000	PCS																						
KRS0010A	KIT RESISTANCE RS0010A	<table border="1"> <thead> <tr> <th>Code</th> <th>Description</th> <th>Qté</th> <th>UOM</th> </tr> </thead> <tbody> <tr> <td>GN1326A1</td> <td>JOINT RESISTANCE 71x19 G6.25</td> <td>1.000</td> <td>PCS</td> </tr> <tr> <td>RS0010A0</td> <td>CIRC.HEAT. ELEMENT 2560W - 220-230 V</td> <td>1.000</td> <td>PCS</td> </tr> <tr> <td>VI1220A1</td> <td>VIS AUTOTARADE UX 4.2x12 TCB MARUTEX PRE</td> <td>3.000</td> <td>PCS</td> </tr> </tbody> </table>	Code	Description	Qté	UOM	GN1326A1	JOINT RESISTANCE 71x19 G6.25	1.000	PCS	RS0010A0	CIRC.HEAT. ELEMENT 2560W - 220-230 V	1.000	PCS	VI1220A1	VIS AUTOTARADE UX 4.2x12 TCB MARUTEX PRE	3.000	PCS							
Code	Description	Qté	UOM																						
GN1326A1	JOINT RESISTANCE 71x19 G6.25	1.000	PCS																						
RS0010A0	CIRC.HEAT. ELEMENT 2560W - 220-230 V	1.000	PCS																						
VI1220A1	VIS AUTOTARADE UX 4.2x12 TCB MARUTEX PRE	3.000	PCS																						
KG1326A	KIT 5 PCS JOINT RESISTANCE GN136A1	<table border="1"> <thead> <tr> <th>Code</th> <th>Description</th> <th>Qté</th> <th>UOM</th> </tr> </thead> <tbody> <tr> <td>GN1326A1</td> <td>JOINT RESISTANCE 71x19 G6.25</td> <td>5.000</td> <td>PCS</td> </tr> </tbody> </table>	Code	Description	Qté	UOM	GN1326A1	JOINT RESISTANCE 71x19 G6.25	5.000	PCS															
Code	Description	Qté	UOM																						
GN1326A1	JOINT RESISTANCE 71x19 G6.25	5.000	PCS																						
RS1274A	RESISTANCE PLATE 100W 60V 1 TOUR		KRS1036A	KIT RESISTANCE DE FREINAGE 100W MM GAS	<table border="1"> <thead> <tr> <th>Code</th> <th>Description</th> <th>Qté</th> <th>UOM</th> </tr> </thead> <tbody> <tr> <td>GN1672A1</td> <td>JOINT RESISTANCE FREIN</td> <td>1.000</td> <td>PCS</td> </tr> <tr> <td>RS1036A0</td> <td>100W 60V 1 TURN FLAT ELEMENT</td> <td>1.000</td> <td>PCS</td> </tr> <tr> <td>SL1045A0</td> <td>SILICONE ANTHRACITE S57 sp-5007 80ml</td> <td>1.000</td> <td>PCS</td> </tr> <tr> <td>VI1220A1</td> <td>VIS AUTOTARADE UX 4.2x12 TCB MARUTEX PRE</td> <td>2.000</td> <td>PCS</td> </tr> </tbody> </table>	Code	Description	Qté	UOM	GN1672A1	JOINT RESISTANCE FREIN	1.000	PCS	RS1036A0	100W 60V 1 TURN FLAT ELEMENT	1.000	PCS	SL1045A0	SILICONE ANTHRACITE S57 sp-5007 80ml	1.000	PCS	VI1220A1	VIS AUTOTARADE UX 4.2x12 TCB MARUTEX PRE	2.000	PCS
Code	Description	Qté	UOM																						
GN1672A1	JOINT RESISTANCE FREIN	1.000	PCS																						
RS1036A0	100W 60V 1 TURN FLAT ELEMENT	1.000	PCS																						
SL1045A0	SILICONE ANTHRACITE S57 sp-5007 80ml	1.000	PCS																						
VI1220A1	VIS AUTOTARADE UX 4.2x12 TCB MARUTEX PRE	2.000	PCS																						

COMPOSANT			PIÈCE DE RECHANGE																						
Code	Description	Image	Code	Description	Composants du kit																				
GN1588A	JOINT RESISTANCE 78x28 G6 25		KGN1588A	KIT 2 PC JOINT DE RÉSISTANCE 78X28	<table border="1"> <thead> <tr> <th>Code</th> <th>Description</th> <th>Qté</th> <th>UOM</th> </tr> </thead> <tbody> <tr> <td>GN1588A0</td> <td>JOINT RESISTANCE 78x28 G6 25</td> <td>2.000</td> <td>PCS</td> </tr> </tbody> </table>	Code	Description	Qté	UOM	GN1588A0	JOINT RESISTANCE 78x28 G6 25	2.000	PCS												
Code	Description	Qté	UOM																						
GN1588A0	JOINT RESISTANCE 78x28 G6 25	2.000	PCS																						
VM2416A	PIVOT GUIDE BLOCAGE FUMOIR		VM2416A0	PIVOT GUIDE BLOCAGE FUMOIR																					
0H4305A	DISQUE ETANCHEITE ARBRE MOTEUR INOX STP		K0H4305A	KIT DISQUE TENUE ARBRE MOTEUR	<table border="1"> <thead> <tr> <th>Code</th> <th>Description</th> <th>Qté</th> <th>UOM</th> </tr> </thead> <tbody> <tr> <td>0H8118A0</td> <td>DISQUE TENUE ARBRE MOTEUR XEVL</td> <td>1.000</td> <td>PCS</td> </tr> <tr> <td>GN1140A3</td> <td>JOINT SUPPORT MOTEUR IMPRIME</td> <td>1.000</td> <td>PCS</td> </tr> <tr> <td>SL1045A0</td> <td>SILICONE ANTHRACITE S57 sp-5007 80ml</td> <td>1.000</td> <td>PCS</td> </tr> <tr> <td>VI1220A1</td> <td>VIS AUTOTARADE UX 4.2x12 TCB MARUTEX PRE</td> <td>3.000</td> <td>PCS</td> </tr> </tbody> </table>	Code	Description	Qté	UOM	0H8118A0	DISQUE TENUE ARBRE MOTEUR XEVL	1.000	PCS	GN1140A3	JOINT SUPPORT MOTEUR IMPRIME	1.000	PCS	SL1045A0	SILICONE ANTHRACITE S57 sp-5007 80ml	1.000	PCS	VI1220A1	VIS AUTOTARADE UX 4.2x12 TCB MARUTEX PRE	3.000	PCS
Code	Description	Qté	UOM																						
0H8118A0	DISQUE TENUE ARBRE MOTEUR XEVL	1.000	PCS																						
GN1140A3	JOINT SUPPORT MOTEUR IMPRIME	1.000	PCS																						
SL1045A0	SILICONE ANTHRACITE S57 sp-5007 80ml	1.000	PCS																						
VI1220A1	VIS AUTOTARADE UX 4.2x12 TCB MARUTEX PRE	3.000	PCS																						
0H7170A	PRESSE LAINE DE VERRE MOTEUR MM		0H7170A0	PRESSE LAINE DE VERRE MOTEUR MM																					

COMPOSANT			PIÈCE DE RECHANGE																													
Code	Description	Image	Code	Description	Composants du kit																											
VN1170B	TURBINE D195 H80 8 PALES ECROU M8+BAGUE		KVN1184A	KIT VENTILATEUR D195 H80 8 PALE DECHARG	<table border="1"> <thead> <tr> <th>Code</th> <th>Description</th> <th>Qté</th> <th>UOM</th> </tr> </thead> <tbody> <tr> <td>VI1122A0</td> <td>A4 316 M6X12 SCREW</td> <td>1.000</td> <td>PCS</td> </tr> <tr> <td>VI1123A0</td> <td>A4 ST. STEEL FLAT WASHER FOR M6</td> <td>1.000</td> <td>PCS</td> </tr> <tr> <td>VN1184A0</td> <td>D195 H80 8 CONCAVE BLADES FAN</td> <td>1.000</td> <td>PCS</td> </tr> </tbody> </table>	Code	Description	Qté	UOM	VI1122A0	A4 316 M6X12 SCREW	1.000	PCS	VI1123A0	A4 ST. STEEL FLAT WASHER FOR M6	1.000	PCS	VN1184A0	D195 H80 8 CONCAVE BLADES FAN	1.000	PCS											
					Code	Description	Qté	UOM																								
VI1122A0	A4 316 M6X12 SCREW	1.000	PCS																													
VI1123A0	A4 ST. STEEL FLAT WASHER FOR M6	1.000	PCS																													
VN1184A0	D195 H80 8 CONCAVE BLADES FAN	1.000	PCS																													
<table border="1"> <thead> <tr> <th>Code</th> <th>Description</th> <th>Qté</th> <th>UOM</th> </tr> </thead> <tbody> <tr> <td>0G1552C0</td> <td>TOLE PROTECTION TURBINE COMPLETE AVEC VO</td> <td>1.000</td> <td>PCS</td> </tr> <tr> <td>TB2952B0</td> <td>TUYAU INTERNE HUMIDITE INF XEVC-0711-E</td> <td>1.000</td> <td>PCS</td> </tr> <tr> <td>TB2983B0</td> <td>KIT TUYAU HUMIDITE 2 VOIES XEVC-0711-E</td> <td>1.000</td> <td>PCS</td> </tr> <tr> <td>VI1220A1</td> <td>VIS AUTOTARADE UX 4.2x12 TCB MARUTEX PRE</td> <td>3.000</td> <td>PCS</td> </tr> <tr> <td>VM2251A0</td> <td>STEAM WATER INLET UPPER DISTRIBUTOR</td> <td>1.000</td> <td>PCS</td> </tr> <tr> <td>VM2252A0</td> <td>STEAM WATER INLET LOWER DISTRIBUTOR</td> <td>1.000</td> <td>PCS</td> </tr> <tr> <td>VM2332A2</td> <td>STEAM WATER PIPES BUSHING</td> <td>1.000</td> <td>PCS</td> </tr> </tbody> </table>	Code	Description	Qté	UOM	0G1552C0	TOLE PROTECTION TURBINE COMPLETE AVEC VO	1.000	PCS	TB2952B0	TUYAU INTERNE HUMIDITE INF XEVC-0711-E	1.000	PCS	TB2983B0	KIT TUYAU HUMIDITE 2 VOIES XEVC-0711-E	1.000	PCS	VI1220A1	VIS AUTOTARADE UX 4.2x12 TCB MARUTEX PRE	3.000	PCS	VM2251A0	STEAM WATER INLET UPPER DISTRIBUTOR	1.000	PCS	VM2252A0	STEAM WATER INLET LOWER DISTRIBUTOR	1.000	PCS	VM2332A2	STEAM WATER PIPES BUSHING	1.000	PCS
Code	Description	Qté	UOM																													
0G1552C0	TOLE PROTECTION TURBINE COMPLETE AVEC VO	1.000	PCS																													
TB2952B0	TUYAU INTERNE HUMIDITE INF XEVC-0711-E	1.000	PCS																													
TB2983B0	KIT TUYAU HUMIDITE 2 VOIES XEVC-0711-E	1.000	PCS																													
VI1220A1	VIS AUTOTARADE UX 4.2x12 TCB MARUTEX PRE	3.000	PCS																													
VM2251A0	STEAM WATER INLET UPPER DISTRIBUTOR	1.000	PCS																													
VM2252A0	STEAM WATER INLET LOWER DISTRIBUTOR	1.000	PCS																													
VM2332A2	STEAM WATER PIPES BUSHING	1.000	PCS																													
0G1552B	CARTER COMPLET AVEC BAVURES XEVC0711-E		K0G1552C	KIT TOLE PROT TURB XEVC-0711-E																												
VM2251A	STEAM WATER INLET UPPER DISTRIBUTOR		KVM2251A	KIT DISTRIBUTEURS HUMIDITE SUP ET IN	<table border="1"> <thead> <tr> <th>Code</th> <th>Description</th> <th>Qté</th> <th>UOM</th> </tr> </thead> <tbody> <tr> <td>VM2251A0</td> <td>STEAM WATER INLET UPPER DISTRIBUTOR</td> <td>1.000</td> <td>PCS</td> </tr> <tr> <td>VM2252A0</td> <td>STEAM WATER INLET LOWER DISTRIBUTOR</td> <td>1.000</td> <td>PCS</td> </tr> </tbody> </table>	Code	Description	Qté	UOM	VM2251A0	STEAM WATER INLET UPPER DISTRIBUTOR	1.000	PCS	VM2252A0	STEAM WATER INLET LOWER DISTRIBUTOR	1.000	PCS															
					Code	Description	Qté	UOM																								
VM2251A0	STEAM WATER INLET UPPER DISTRIBUTOR	1.000	PCS																													
VM2252A0	STEAM WATER INLET LOWER DISTRIBUTOR	1.000	PCS																													



COMPOSANT			PIÈCE DE RECHANGE														
Code	Description	Image	Code	Description	Composants du kit												
VM2252A	STEAM WATER INLET LOWER DISTRIBUTOR		KVM2251A	KIT DISTRIBUTEURS HUMIDITE SUP ET IN	<table border="1"> <thead> <tr> <th>Code</th> <th>Description</th> <th>Qté</th> <th>UOM</th> </tr> </thead> <tbody> <tr> <td>VM2251A0</td> <td>STEAM WATER INLET UPPER DISTRIBUTOR</td> <td>1.000</td> <td>PCS</td> </tr> <tr> <td>VM2252A0</td> <td>STEAM WATER INLET LOWER DISTRIBUTOR</td> <td>1.000</td> <td>PCS</td> </tr> </tbody> </table>	Code	Description	Qté	UOM	VM2251A0	STEAM WATER INLET UPPER DISTRIBUTOR	1.000	PCS	VM2252A0	STEAM WATER INLET LOWER DISTRIBUTOR	1.000	PCS
					Code	Description	Qté	UOM									
VM2251A0	STEAM WATER INLET UPPER DISTRIBUTOR	1.000	PCS														
VM2252A0	STEAM WATER INLET LOWER DISTRIBUTOR	1.000	PCS														
TB2983A	XEVC-0711-E 2 WAYS INTERNAL WATER PIPE		KTB2983A	KIT TUYAU HUMIDITE 2 VOIES TB2983A	<table border="1"> <thead> <tr> <th>Code</th> <th>Description</th> <th>Qté</th> <th>UOM</th> </tr> </thead> <tbody> <tr> <td>TB2983A0</td> <td>XEVC-0711-E 2 WAYS INTERNAL WATER PIPE</td> <td>1.000</td> <td>PCS</td> </tr> </tbody> </table>	Code	Description	Qté	UOM	TB2983A0	XEVC-0711-E 2 WAYS INTERNAL WATER PIPE	1.000	PCS				
Code	Description	Qté	UOM														
TB2983A0	XEVC-0711-E 2 WAYS INTERNAL WATER PIPE	1.000	PCS														
TB2953A	TB2953A0		TB2983A0	XEVC-0711-E 2 WAYS INTERNAL WATER PIPE													
TB2952A	XEVC-0711-E INT HUMIDITY PIPE		KTB2952A	KIT TUYAU INT HUMIDITE INF XEVC-0711-E	<table border="1"> <thead> <tr> <th>Code</th> <th>Description</th> <th>Qté</th> <th>UOM</th> </tr> </thead> <tbody> <tr> <td>TB2952A0</td> <td>XEVC-0711-E INT HUMIDITY PIPE</td> <td>1.000</td> <td>PCS</td> </tr> </tbody> </table>	Code	Description	Qté	UOM	TB2952A0	XEVC-0711-E INT HUMIDITY PIPE	1.000	PCS				
Code	Description	Qté	UOM														
TB2952A0	XEVC-0711-E INT HUMIDITY PIPE	1.000	PCS														
VM2332A	STEAM WATER PIPES BUSHING		KVM2332A	KIT BUSELURE TUYAUX HUMIDITE VM2332A0	<table border="1"> <thead> <tr> <th>Code</th> <th>Description</th> <th>Qté</th> <th>UOM</th> </tr> </thead> <tbody> <tr> <td>VM2332A2</td> <td>STEAM WATER PIPES BUSHING</td> <td>1.000</td> <td>PCS</td> </tr> </tbody> </table>	Code	Description	Qté	UOM	VM2332A2	STEAM WATER PIPES BUSHING	1.000	PCS				
Code	Description	Qté	UOM														
VM2332A2	STEAM WATER PIPES BUSHING	1.000	PCS														



COMPOSANT			PIÈCE DE RECHANGE																						
Code	Description	Image	Code	Description	Composants du kit																				
SN1002A	SONDE A COEUR MULTIPOINT L2050		KSN1020A	KIT SONDE A COEUR MULTIPOINT L2050 US	<table border="1"> <thead> <tr> <th>Code</th> <th>Description</th> <th>Qté</th> <th>UOM</th> </tr> </thead> <tbody> <tr> <td>CE1037A0</td> <td>GAINÉ SILICONE EN FIBRE DE VERRE</td> <td>0.700</td> <td>M</td> </tr> <tr> <td>CE1685A0</td> <td>CONNECTEUR FEMELLE MRT8 P3,81 5P</td> <td>1.000</td> <td>PCS</td> </tr> <tr> <td>RC1130A0</td> <td>COLLIER 130X2,6</td> <td>2.000</td> <td>PCS</td> </tr> <tr> <td>SN1002A5</td> <td>SONDE A COEUR MULTIPOINT L2050</td> <td>1.000</td> <td>PCS</td> </tr> </tbody> </table>	Code	Description	Qté	UOM	CE1037A0	GAINÉ SILICONE EN FIBRE DE VERRE	0.700	M	CE1685A0	CONNECTEUR FEMELLE MRT8 P3,81 5P	1.000	PCS	RC1130A0	COLLIER 130X2,6	2.000	PCS	SN1002A5	SONDE A COEUR MULTIPOINT L2050	1.000	PCS
			Code	Description	Qté	UOM																			
CE1037A0	GAINÉ SILICONE EN FIBRE DE VERRE	0.700	M																						
CE1685A0	CONNECTEUR FEMELLE MRT8 P3,81 5P	1.000	PCS																						
RC1130A0	COLLIER 130X2,6	2.000	PCS																						
SN1002A5	SONDE A COEUR MULTIPOINT L2050	1.000	PCS																						
KSN1002A	KIT SONDE A COEUR MULTIPOINT L2050	<table border="1"> <thead> <tr> <th>Code</th> <th>Description</th> <th>Qté</th> <th>UOM</th> </tr> </thead> <tbody> <tr> <td>CE1685A0</td> <td>CONNECTEUR FEMELLE MRT8 P3,81 5P</td> <td>1.000</td> <td>PCS</td> </tr> <tr> <td>SN1002A5</td> <td>SONDE A COEUR MULTIPOINT L2050</td> <td>1.000</td> <td>PCS</td> </tr> </tbody> </table>	Code	Description	Qté	UOM	CE1685A0	CONNECTEUR FEMELLE MRT8 P3,81 5P	1.000	PCS	SN1002A5	SONDE A COEUR MULTIPOINT L2050	1.000	PCS											
Code	Description	Qté	UOM																						
CE1685A0	CONNECTEUR FEMELLE MRT8 P3,81 5P	1.000	PCS																						
SN1002A5	SONDE A COEUR MULTIPOINT L2050	1.000	PCS																						
GRL1395A	7 GN1/1 0711 RIGHT LATERAL SUPPORT		KGRL1395A	KIT SUPPORT LATERAL 7 GN1/1 0711	<table border="1"> <thead> <tr> <th>Code</th> <th>Description</th> <th>Qté</th> <th>UOM</th> </tr> </thead> <tbody> <tr> <td>0H7302B0</td> <td>PROFIL SUPPORT 0H7312 0H731</td> <td>1.000</td> <td>PCS</td> </tr> <tr> <td>0H7303B0</td> <td>PROFIL SUPPORT 0H7314 0H731</td> <td>1.000</td> <td>PCS</td> </tr> <tr> <td>GRL1395A2</td> <td>SUPPORT LAT DROIT 7 GN1/1 0711</td> <td>1.000</td> <td>PCS</td> </tr> <tr> <td>GRL1396A2</td> <td>SUPPORT LAT GAUCHE 7 GN1/1 0711</td> <td>1.000</td> <td>PCS</td> </tr> </tbody> </table>	Code	Description	Qté	UOM	0H7302B0	PROFIL SUPPORT 0H7312 0H731	1.000	PCS	0H7303B0	PROFIL SUPPORT 0H7314 0H731	1.000	PCS	GRL1395A2	SUPPORT LAT DROIT 7 GN1/1 0711	1.000	PCS	GRL1396A2	SUPPORT LAT GAUCHE 7 GN1/1 0711	1.000	PCS
					Code	Description	Qté	UOM																	
					0H7302B0	PROFIL SUPPORT 0H7312 0H731	1.000	PCS																	
					0H7303B0	PROFIL SUPPORT 0H7314 0H731	1.000	PCS																	
GRL1395A2	SUPPORT LAT DROIT 7 GN1/1 0711	1.000	PCS																						
GRL1396A2	SUPPORT LAT GAUCHE 7 GN1/1 0711	1.000	PCS																						
0H7302B0	PROFIL SUPPORT 0H7312 0H731	1.000	PCS																						
0H7303B0	PROFIL SUPPORT 0H7314 0H731	1.000	PCS																						
GRL1395A2	SUPPORT LAT DROIT 7 GN1/1 0711	1.000	PCS																						
GRL1396A2	SUPPORT LAT GAUCHE 7 GN1/1 0711	1.000	PCS																						
GRL1396A	7 GN1/1 0711 LEFT LATERAL SUPPORT		KGRL1395A	KIT SUPPORT LATERAL 7 GN1/1 0711	<table border="1"> <thead> <tr> <th>Code</th> <th>Description</th> <th>Qté</th> <th>UOM</th> </tr> </thead> <tbody> <tr> <td>0H7302B0</td> <td>PROFIL SUPPORT 0H7312 0H731</td> <td>1.000</td> <td>PCS</td> </tr> <tr> <td>0H7303B0</td> <td>PROFIL SUPPORT 0H7314 0H731</td> <td>1.000</td> <td>PCS</td> </tr> <tr> <td>GRL1395A2</td> <td>SUPPORT LAT DROIT 7 GN1/1 0711</td> <td>1.000</td> <td>PCS</td> </tr> <tr> <td>GRL1396A2</td> <td>SUPPORT LAT GAUCHE 7 GN1/1 0711</td> <td>1.000</td> <td>PCS</td> </tr> </tbody> </table>	Code	Description	Qté	UOM	0H7302B0	PROFIL SUPPORT 0H7312 0H731	1.000	PCS	0H7303B0	PROFIL SUPPORT 0H7314 0H731	1.000	PCS	GRL1395A2	SUPPORT LAT DROIT 7 GN1/1 0711	1.000	PCS	GRL1396A2	SUPPORT LAT GAUCHE 7 GN1/1 0711	1.000	PCS
					Code	Description	Qté	UOM																	
					0H7302B0	PROFIL SUPPORT 0H7312 0H731	1.000	PCS																	
					0H7303B0	PROFIL SUPPORT 0H7314 0H731	1.000	PCS																	
GRL1395A2	SUPPORT LAT DROIT 7 GN1/1 0711	1.000	PCS																						
GRL1396A2	SUPPORT LAT GAUCHE 7 GN1/1 0711	1.000	PCS																						
0H7302B0	PROFIL SUPPORT 0H7312 0H731	1.000	PCS																						
0H7303B0	PROFIL SUPPORT 0H7314 0H731	1.000	PCS																						
GRL1395A2	SUPPORT LAT DROIT 7 GN1/1 0711	1.000	PCS																						
GRL1396A2	SUPPORT LAT GAUCHE 7 GN1/1 0711	1.000	PCS																						

COMPOSANT			PIÈCE DE RECHANGE																		
Code	Description	Image	Code	Description	Composants du kit																
GN1544A	JOINT ENTREE AIR		KTB3128A	KIT TUYAU CONNECT. VENTURI XECC-1013-E	<table border="1"> <thead> <tr> <th>Code</th> <th>Description</th> <th>Qté</th> <th>UOM</th> </tr> </thead> <tbody> <tr> <td>GN1544A0</td> <td>JOINT ENTREE AIR</td> <td>1.000</td> <td>PCS</td> </tr> <tr> <td>GN1584A0</td> <td>CORNER FITTING D30-D16</td> <td>1.000</td> <td>PCS</td> </tr> <tr> <td>TB3128A0</td> <td>TUYEAU SORTIE AIR VENTURI XECC-10</td> <td>1.000</td> <td>PCS</td> </tr> </tbody> </table>	Code	Description	Qté	UOM	GN1544A0	JOINT ENTREE AIR	1.000	PCS	GN1584A0	CORNER FITTING D30-D16	1.000	PCS	TB3128A0	TUYEAU SORTIE AIR VENTURI XECC-10	1.000	PCS
					Code	Description	Qté	UOM													
					GN1544A0	JOINT ENTREE AIR	1.000	PCS													
					GN1584A0	CORNER FITTING D30-D16	1.000	PCS													
			TB3128A0	TUYEAU SORTIE AIR VENTURI XECC-10	1.000	PCS															
			KTB3074B	KIT TUYAU CONNECTEUR VENTURI XEVC-0711-G	<table border="1"> <thead> <tr> <th>Code</th> <th>Description</th> <th>Qté</th> <th>UOM</th> </tr> </thead> <tbody> <tr> <td>GN1544A0</td> <td>JOINT ENTREE AIR</td> <td>1.000</td> <td>PCS</td> </tr> <tr> <td>GN1584A0</td> <td>CORNER FITTING D30-D16</td> <td>1.000</td> <td>PCS</td> </tr> <tr> <td>RC1042A0</td> <td>DOUBLE WIRE SPRING CLAMP D21.5-22.6</td> <td>1.000</td> <td>PCS</td> </tr> </tbody> </table>	Code	Description	Qté	UOM	GN1544A0	JOINT ENTREE AIR	1.000	PCS	GN1584A0	CORNER FITTING D30-D16	1.000	PCS	RC1042A0	DOUBLE WIRE SPRING CLAMP D21.5-22.6	1.000	PCS
					Code	Description	Qté	UOM													
					GN1544A0	JOINT ENTREE AIR	1.000	PCS													
					GN1584A0	CORNER FITTING D30-D16	1.000	PCS													
			RC1042A0	DOUBLE WIRE SPRING CLAMP D21.5-22.6	1.000	PCS															
			KTB3068B	KIT TUYAU CONNECT. VENTURI 10FS/EU/21-G	<table border="1"> <thead> <tr> <th>Code</th> <th>Description</th> <th>Qté</th> <th>UOM</th> </tr> </thead> <tbody> <tr> <td>GN1544A0</td> <td>JOINT ENTREE AIR</td> <td>2.000</td> <td>PCS</td> </tr> <tr> <td>GN1584A0</td> <td>CORNER FITTING D30-D16</td> <td>1.000</td> <td>PCS</td> </tr> </tbody> </table>	Code	Description	Qté	UOM	GN1544A0	JOINT ENTREE AIR	2.000	PCS	GN1584A0	CORNER FITTING D30-D16	1.000	PCS				
					Code	Description	Qté	UOM													
GN1544A0	JOINT ENTREE AIR	2.000	PCS																		
GN1584A0	CORNER FITTING D30-D16	1.000	PCS																		
KTB3019A	KIT TUYAU CONNECT VENTURI SUP 20XX/16XX	<table border="1"> <thead> <tr> <th>Code</th> <th>Description</th> <th>Qté</th> <th>UOM</th> </tr> </thead> <tbody> <tr> <td>RC1042A0</td> <td>DOUBLE WIRE SPRING CLAMP D21.5-22.6</td> <td>1.000</td> <td>PCS</td> </tr> <tr> <td>TB3068B0</td> <td>XEBC-10 VENTURI AIR COLLECTOR PIPE D30</td> <td>1.000</td> <td>PCS</td> </tr> <tr> <td>VM1794A0</td> <td>PLAQUETTE NOIRE 250X4.8 PA66</td> <td>1.000</td> <td>PCS</td> </tr> </tbody> </table>	Code	Description	Qté	UOM	RC1042A0	DOUBLE WIRE SPRING CLAMP D21.5-22.6	1.000	PCS	TB3068B0	XEBC-10 VENTURI AIR COLLECTOR PIPE D30	1.000	PCS	VM1794A0	PLAQUETTE NOIRE 250X4.8 PA66	1.000	PCS			
		Code	Description	Qté	UOM																
		RC1042A0	DOUBLE WIRE SPRING CLAMP D21.5-22.6	1.000	PCS																
		TB3068B0	XEBC-10 VENTURI AIR COLLECTOR PIPE D30	1.000	PCS																
		VM1794A0	PLAQUETTE NOIRE 250X4.8 PA66	1.000	PCS																
		KTB3019A	KIT TUYAU CONNECT VENTURI SUP 20XX/16XX	<table border="1"> <thead> <tr> <th>Code</th> <th>Description</th> <th>Qté</th> <th>UOM</th> </tr> </thead> <tbody> <tr> <td>GN1544A0</td> <td>JOINT ENTREE AIR</td> <td>1.000</td> <td>PCS</td> </tr> <tr> <td>GN1584A0</td> <td>CORNER FITTING D30-D16</td> <td>1.000</td> <td>PCS</td> </tr> </tbody> </table>	Code	Description	Qté	UOM	GN1544A0	JOINT ENTREE AIR	1.000	PCS	GN1584A0	CORNER FITTING D30-D16	1.000	PCS					
Code	Description			Qté	UOM																
GN1544A0	JOINT ENTREE AIR	1.000	PCS																		
GN1584A0	CORNER FITTING D30-D16	1.000	PCS																		

COMPOSANT			PIÈCE DE RECHANGE																		
Code	Description	Image	Code	Description	Composants du kit																
GN1544A	JOINT ENTREE AIR		KTB3019A	KIT TUYAU CONNECT VENTURI SUP 20XX/16XX	<table border="1"> <thead> <tr> <th>Code</th> <th>Description</th> <th>Qté</th> <th>UOM</th> </tr> </thead> <tbody> <tr> <td>RC1042A0</td> <td>DOUBLE WIRE SPRING CLAMP D21.5-22.6</td> <td>1.000</td> <td>PCS</td> </tr> <tr> <td>TB3019A1</td> <td>XEVC-2011 UPPER AIR INLET PIPE D3</td> <td>1.000</td> <td>PCS</td> </tr> <tr> <td>VM1794A0</td> <td>PLAQUETTE NOIRE 250X4.8 PA66</td> <td>1.000</td> <td>PCS</td> </tr> </tbody> </table>	Code	Description	Qté	UOM	RC1042A0	DOUBLE WIRE SPRING CLAMP D21.5-22.6	1.000	PCS	TB3019A1	XEVC-2011 UPPER AIR INLET PIPE D3	1.000	PCS	VM1794A0	PLAQUETTE NOIRE 250X4.8 PA66	1.000	PCS
					Code	Description	Qté	UOM													
					RC1042A0	DOUBLE WIRE SPRING CLAMP D21.5-22.6	1.000	PCS													
					TB3019A1	XEVC-2011 UPPER AIR INLET PIPE D3	1.000	PCS													
			VM1794A0	PLAQUETTE NOIRE 250X4.8 PA66	1.000	PCS															
			KTB2979C	KIT TUYAU CONNECTEUR VENTURI XEBC-10XX-E	<table border="1"> <thead> <tr> <th>Code</th> <th>Description</th> <th>Qté</th> <th>UOM</th> </tr> </thead> <tbody> <tr> <td>GN1544A0</td> <td>JOINT ENTREE AIR</td> <td>2.000</td> <td>PCS</td> </tr> <tr> <td>GN1584A0</td> <td>CORNER FITTING D30-D16</td> <td>1.000</td> <td>PCS</td> </tr> <tr> <td>RC1042A0</td> <td>DOUBLE WIRE SPRING CLAMP D21.5-22.6</td> <td>1.000</td> <td>PCS</td> </tr> </tbody> </table>	Code	Description	Qté	UOM	GN1544A0	JOINT ENTREE AIR	2.000	PCS	GN1584A0	CORNER FITTING D30-D16	1.000	PCS	RC1042A0	DOUBLE WIRE SPRING CLAMP D21.5-22.6	1.000	PCS
					Code	Description	Qté	UOM													
					GN1544A0	JOINT ENTREE AIR	2.000	PCS													
					GN1584A0	CORNER FITTING D30-D16	1.000	PCS													
			RC1042A0	DOUBLE WIRE SPRING CLAMP D21.5-22.6	1.000	PCS															
			KTB2978B	KIT TUYAU CONNECTEUR VENTURI 06EU/FS/2	<table border="1"> <thead> <tr> <th>Code</th> <th>Description</th> <th>Qté</th> <th>UOM</th> </tr> </thead> <tbody> <tr> <td>GN1544A0</td> <td>JOINT ENTREE AIR</td> <td>1.000</td> <td>PCS</td> </tr> <tr> <td>GN1584A0</td> <td>CORNER FITTING D30-D16</td> <td>1.000</td> <td>PCS</td> </tr> <tr> <td>RC1042A0</td> <td>DOUBLE WIRE SPRING CLAMP D21.5-22.6</td> <td>1.000</td> <td>PCS</td> </tr> </tbody> </table>	Code	Description	Qté	UOM	GN1544A0	JOINT ENTREE AIR	1.000	PCS	GN1584A0	CORNER FITTING D30-D16	1.000	PCS	RC1042A0	DOUBLE WIRE SPRING CLAMP D21.5-22.6	1.000	PCS
					Code	Description	Qté	UOM													
GN1544A0	JOINT ENTREE AIR	1.000			PCS																
GN1584A0	CORNER FITTING D30-D16	1.000			PCS																
RC1042A0	DOUBLE WIRE SPRING CLAMP D21.5-22.6	1.000	PCS																		
KTB2959B	KIT TUYAU CONNECTEUR VENTURI XEVC-1011-E	<table border="1"> <thead> <tr> <th>Code</th> <th>Description</th> <th>Qté</th> <th>UOM</th> </tr> </thead> <tbody> <tr> <td>GN1544A0</td> <td>JOINT ENTREE AIR</td> <td>2.000</td> <td>PCS</td> </tr> <tr> <td>GN1584A0</td> <td>CORNER FITTING D30-D16</td> <td>1.000</td> <td>PCS</td> </tr> <tr> <td>TB2979C0</td> <td>XEBC-10 VENTURI AIR COLLECTOR PIPE D30</td> <td>1.000</td> <td>PCS</td> </tr> </tbody> </table>	Code	Description	Qté	UOM	GN1544A0	JOINT ENTREE AIR	2.000	PCS	GN1584A0	CORNER FITTING D30-D16	1.000	PCS	TB2979C0	XEBC-10 VENTURI AIR COLLECTOR PIPE D30	1.000	PCS			
		Code	Description	Qté	UOM																
		GN1544A0	JOINT ENTREE AIR	2.000	PCS																
		GN1584A0	CORNER FITTING D30-D16	1.000	PCS																
TB2979C0	XEBC-10 VENTURI AIR COLLECTOR PIPE D30	1.000	PCS																		
KTB2978B	KIT TUYAU CONNECTEUR VENTURI 06EU/FS/2	<table border="1"> <thead> <tr> <th>Code</th> <th>Description</th> <th>Qté</th> <th>UOM</th> </tr> </thead> <tbody> <tr> <td>GN1544A0</td> <td>JOINT ENTREE AIR</td> <td>1.000</td> <td>PCS</td> </tr> <tr> <td>GN1584A0</td> <td>CORNER FITTING D30-D16</td> <td>1.000</td> <td>PCS</td> </tr> <tr> <td>RC1042A0</td> <td>DOUBLE WIRE SPRING CLAMP D21.5-22.6</td> <td>1.000</td> <td>PCS</td> </tr> </tbody> </table>	Code	Description	Qté	UOM	GN1544A0	JOINT ENTREE AIR	1.000	PCS	GN1584A0	CORNER FITTING D30-D16	1.000	PCS	RC1042A0	DOUBLE WIRE SPRING CLAMP D21.5-22.6	1.000	PCS			
		Code	Description	Qté	UOM																
		GN1544A0	JOINT ENTREE AIR	1.000	PCS																
		GN1584A0	CORNER FITTING D30-D16	1.000	PCS																
RC1042A0	DOUBLE WIRE SPRING CLAMP D21.5-22.6	1.000	PCS																		
KTB2959B	KIT TUYAU CONNECTEUR VENTURI XEVC-1011-E	<table border="1"> <thead> <tr> <th>Code</th> <th>Description</th> <th>Qté</th> <th>UOM</th> </tr> </thead> <tbody> <tr> <td>GN1544A0</td> <td>JOINT ENTREE AIR</td> <td>2.000</td> <td>PCS</td> </tr> <tr> <td>GN1584A0</td> <td>CORNER FITTING D30-D16</td> <td>1.000</td> <td>PCS</td> </tr> <tr> <td>VM1794A0</td> <td>PLAQUETTE NOIRE 250X4.8 PA66</td> <td>1.000</td> <td>PCS</td> </tr> </tbody> </table>	Code	Description	Qté	UOM	GN1544A0	JOINT ENTREE AIR	2.000	PCS	GN1584A0	CORNER FITTING D30-D16	1.000	PCS	VM1794A0	PLAQUETTE NOIRE 250X4.8 PA66	1.000	PCS			
		Code	Description	Qté	UOM																
		GN1544A0	JOINT ENTREE AIR	2.000	PCS																
		GN1584A0	CORNER FITTING D30-D16	1.000	PCS																
VM1794A0	PLAQUETTE NOIRE 250X4.8 PA66	1.000	PCS																		
KTB2959B	KIT TUYAU CONNECTEUR VENTURI XEVC-1011-E	<table border="1"> <thead> <tr> <th>Code</th> <th>Description</th> <th>Qté</th> <th>UOM</th> </tr> </thead> <tbody> <tr> <td>GN1544A0</td> <td>JOINT ENTREE AIR</td> <td>2.000</td> <td>PCS</td> </tr> <tr> <td>GN1584A0</td> <td>CORNER FITTING D30-D16</td> <td>1.000</td> <td>PCS</td> </tr> <tr> <td>VM1794A0</td> <td>PLAQUETTE NOIRE 250X4.8 PA66</td> <td>1.000</td> <td>PCS</td> </tr> </tbody> </table>	Code	Description	Qté	UOM	GN1544A0	JOINT ENTREE AIR	2.000	PCS	GN1584A0	CORNER FITTING D30-D16	1.000	PCS	VM1794A0	PLAQUETTE NOIRE 250X4.8 PA66	1.000	PCS			
		Code	Description	Qté	UOM																
		GN1544A0	JOINT ENTREE AIR	2.000	PCS																
		GN1584A0	CORNER FITTING D30-D16	1.000	PCS																
VM1794A0	PLAQUETTE NOIRE 250X4.8 PA66	1.000	PCS																		

COMPOSANT			PIÈCE DE RECHANGE																							
Code	Description	Image	Code	Description	Composants du kit																					
GN1544A	JOINT ENTREE AIR		KTB2959B	KIT TUYAU CONNECTEUR VENTURI XEVC-1011-E	<table border="1"> <thead> <tr> <th>Code</th> <th>Description</th> <th>Qté</th> <th>UOM</th> </tr> </thead> <tbody> <tr> <td>RC1042A0</td> <td>DOUBLE WIRE SPRING CLAMP D21.5-22.6</td> <td>1.000</td> <td>PCS</td> </tr> <tr> <td>TB2959B0</td> <td>XEVC-1011-E VENTURI PIPE</td> <td>1.000</td> <td>PCS</td> </tr> <tr> <td>VM1794A0</td> <td>PLAQUETTE NOIRE 250X4.8 PA66</td> <td>1.000</td> <td>PCS</td> </tr> </tbody> </table>	Code	Description	Qté	UOM	RC1042A0	DOUBLE WIRE SPRING CLAMP D21.5-22.6	1.000	PCS	TB2959B0	XEVC-1011-E VENTURI PIPE	1.000	PCS	VM1794A0	PLAQUETTE NOIRE 250X4.8 PA66	1.000	PCS					
			Code	Description	Qté	UOM																				
			RC1042A0	DOUBLE WIRE SPRING CLAMP D21.5-22.6	1.000	PCS																				
			TB2959B0	XEVC-1011-E VENTURI PIPE	1.000	PCS																				
VM1794A0	PLAQUETTE NOIRE 250X4.8 PA66	1.000	PCS																							
KTB2958B	KIT TUYAU CONNECTEUR VENTURI XEVC-0711-E	<table border="1"> <thead> <tr> <th>Code</th> <th>Description</th> <th>Qté</th> <th>UOM</th> </tr> </thead> <tbody> <tr> <td>GN1544A0</td> <td>JOINT ENTREE AIR</td> <td>1.000</td> <td>PCS</td> </tr> <tr> <td>GN1584A0</td> <td>CORNER FITTING D30-D16</td> <td>1.000</td> <td>PCS</td> </tr> <tr> <td>RC1042A0</td> <td>DOUBLE WIRE SPRING CLAMP D21.5-22.6</td> <td>1.000</td> <td>PCS</td> </tr> <tr> <td>TB2958B0</td> <td>XEVC-0711-E VENTURI PIPE</td> <td>1.000</td> <td>PCS</td> </tr> </tbody> </table>	Code	Description	Qté	UOM	GN1544A0	JOINT ENTREE AIR	1.000	PCS	GN1584A0	CORNER FITTING D30-D16	1.000	PCS	RC1042A0	DOUBLE WIRE SPRING CLAMP D21.5-22.6	1.000	PCS	TB2958B0	XEVC-0711-E VENTURI PIPE	1.000	PCS				
Code	Description	Qté	UOM																							
GN1544A0	JOINT ENTREE AIR	1.000	PCS																							
GN1584A0	CORNER FITTING D30-D16	1.000	PCS																							
RC1042A0	DOUBLE WIRE SPRING CLAMP D21.5-22.6	1.000	PCS																							
TB2958B0	XEVC-0711-E VENTURI PIPE	1.000	PCS																							
KTB2957B	KIT TUYAU CONNECTEUR VENTURI 0511/04EU-E	<table border="1"> <thead> <tr> <th>Code</th> <th>Description</th> <th>Qté</th> <th>UOM</th> </tr> </thead> <tbody> <tr> <td>GN1544A0</td> <td>JOINT ENTREE AIR</td> <td>1.000</td> <td>PCS</td> </tr> <tr> <td>GN1584A0</td> <td>CORNER FITTING D30-D16</td> <td>1.000</td> <td>PCS</td> </tr> <tr> <td>RC1042A0</td> <td>DOUBLE WIRE SPRING CLAMP D21.5-22.6</td> <td>1.000</td> <td>PCS</td> </tr> <tr> <td>TB2957B0</td> <td>XEVC-0511-E VENTURI PIPE</td> <td>1.000</td> <td>PCS</td> </tr> <tr> <td>VM1794A0</td> <td>PLAQUETTE NOIRE 250X4.8 PA66</td> <td>1.000</td> <td>PCS</td> </tr> </tbody> </table>	Code	Description	Qté	UOM	GN1544A0	JOINT ENTREE AIR	1.000	PCS	GN1584A0	CORNER FITTING D30-D16	1.000	PCS	RC1042A0	DOUBLE WIRE SPRING CLAMP D21.5-22.6	1.000	PCS	TB2957B0	XEVC-0511-E VENTURI PIPE	1.000	PCS	VM1794A0	PLAQUETTE NOIRE 250X4.8 PA66	1.000	PCS
Code	Description	Qté	UOM																							
GN1544A0	JOINT ENTREE AIR	1.000	PCS																							
GN1584A0	CORNER FITTING D30-D16	1.000	PCS																							
RC1042A0	DOUBLE WIRE SPRING CLAMP D21.5-22.6	1.000	PCS																							
TB2957B0	XEVC-0511-E VENTURI PIPE	1.000	PCS																							
VM1794A0	PLAQUETTE NOIRE 250X4.8 PA66	1.000	PCS																							
KTB2956A	KIT TUYAU CONNECTEUR VENTURI XEVC-0311-E	<table border="1"> <thead> <tr> <th>Code</th> <th>Description</th> <th>Qté</th> <th>UOM</th> </tr> </thead> <tbody> <tr> <td>GN1544A0</td> <td>JOINT ENTREE AIR</td> <td>1.000</td> <td>PCS</td> </tr> <tr> <td>RC1042A0</td> <td>DOUBLE WIRE SPRING CLAMP D21.5-22.6</td> <td>1.000</td> <td>PCS</td> </tr> <tr> <td>TB2956A0</td> <td>XEVC-0311-E VENTURI PIPE</td> <td>1.000</td> <td>PCS</td> </tr> </tbody> </table>	Code	Description	Qté	UOM	GN1544A0	JOINT ENTREE AIR	1.000	PCS	RC1042A0	DOUBLE WIRE SPRING CLAMP D21.5-22.6	1.000	PCS	TB2956A0	XEVC-0311-E VENTURI PIPE	1.000	PCS								
Code	Description	Qté	UOM																							
GN1544A0	JOINT ENTREE AIR	1.000	PCS																							
RC1042A0	DOUBLE WIRE SPRING CLAMP D21.5-22.6	1.000	PCS																							
TB2956A0	XEVC-0311-E VENTURI PIPE	1.000	PCS																							
KTB2944A	KIT TUYAU CONNECT VENTURI	<table border="1"> <thead> <tr> <th>Code</th> <th>Description</th> <th>Qté</th> <th>UOM</th> </tr> </thead> <tbody> <tr> <td>GN1544A0</td> <td>JOINT ENTREE AIR</td> <td>2.000</td> <td>PCS</td> </tr> </tbody> </table>	Code	Description	Qté	UOM	GN1544A0	JOINT ENTREE AIR	2.000	PCS																
Code	Description	Qté	UOM																							
GN1544A0	JOINT ENTREE AIR	2.000	PCS																							

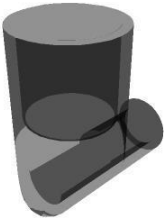
INF 20XX/16XX

COMPOSANT			PIÈCE DE RECHANGE																						
Code	Description	Image	Code	Description	Composants du kit																				
GN1544A	JOINT ENTREE AIR		KTB2944A	KIT TUYAU CONNECT VENTURI INF 20XX/16XX	<table border="1"> <thead> <tr> <th>Code</th> <th>Description</th> <th>Qté</th> <th>UOM</th> </tr> </thead> <tbody> <tr> <td>GN1584A0</td> <td>CORNER FITTING D30-D16</td> <td>1.000</td> <td>PCS</td> </tr> <tr> <td>RC1042A0</td> <td>DOUBLE WIRE SPRING CLAMP D21.5-22.6</td> <td>1.000</td> <td>PCS</td> </tr> <tr> <td>TB2944A1</td> <td>XEVC-2011 AIR INLET PIPE D3</td> <td>1.000</td> <td>PCS</td> </tr> <tr> <td>VM1794A0</td> <td>PLAQUETTE NOIRE 250X4.8 PA66</td> <td>1.000</td> <td>PCS</td> </tr> </tbody> </table>	Code	Description	Qté	UOM	GN1584A0	CORNER FITTING D30-D16	1.000	PCS	RC1042A0	DOUBLE WIRE SPRING CLAMP D21.5-22.6	1.000	PCS	TB2944A1	XEVC-2011 AIR INLET PIPE D3	1.000	PCS	VM1794A0	PLAQUETTE NOIRE 250X4.8 PA66	1.000	PCS
			Code	Description	Qté	UOM																			
			GN1584A0	CORNER FITTING D30-D16	1.000	PCS																			
RC1042A0	DOUBLE WIRE SPRING CLAMP D21.5-22.6	1.000	PCS																						
TB2944A1	XEVC-2011 AIR INLET PIPE D3	1.000	PCS																						
VM1794A0	PLAQUETTE NOIRE 250X4.8 PA66	1.000	PCS																						
KTB1323A	KIT TUYAU CONNECTEUR VENTURI XECC-05XX-E	<table border="1"> <thead> <tr> <th>Code</th> <th>Description</th> <th>Qté</th> <th>UOM</th> </tr> </thead> <tbody> <tr> <td>GN1544A0</td> <td>JOINT ENTREE AIR</td> <td>1.000</td> <td>PCS</td> </tr> <tr> <td>GN1584A0</td> <td>CORNER FITTING D30-D16</td> <td>1.000</td> <td>PCS</td> </tr> <tr> <td>RC1042A0</td> <td>DOUBLE WIRE SPRING CLAMP D21.5-22.6</td> <td>1.000</td> <td>PCS</td> </tr> <tr> <td>TB1323A1</td> <td>TUYEAU SORTIE AIR VENTURI XECC-05xx</td> <td>1.000</td> <td>PCS</td> </tr> </tbody> </table>	Code	Description	Qté	UOM	GN1544A0	JOINT ENTREE AIR	1.000	PCS	GN1584A0	CORNER FITTING D30-D16	1.000	PCS	RC1042A0	DOUBLE WIRE SPRING CLAMP D21.5-22.6	1.000	PCS	TB1323A1	TUYEAU SORTIE AIR VENTURI XECC-05xx	1.000	PCS			
Code	Description	Qté	UOM																						
GN1544A0	JOINT ENTREE AIR	1.000	PCS																						
GN1584A0	CORNER FITTING D30-D16	1.000	PCS																						
RC1042A0	DOUBLE WIRE SPRING CLAMP D21.5-22.6	1.000	PCS																						
TB1323A1	TUYEAU SORTIE AIR VENTURI XECC-05xx	1.000	PCS																						
KGN1544A	KIT JOINT ENTREE AIR 5 PCS	<table border="1"> <thead> <tr> <th>Code</th> <th>Description</th> <th>Qté</th> <th>UOM</th> </tr> </thead> <tbody> <tr> <td>GN1544A0</td> <td>JOINT ENTREE AIR</td> <td>5.000</td> <td>PCS</td> </tr> </tbody> </table>	Code	Description	Qté	UOM	GN1544A0	JOINT ENTREE AIR	5.000	PCS															
Code	Description	Qté	UOM																						
GN1544A0	JOINT ENTREE AIR	5.000	PCS																						
GN1584A	CORNER FITTING D30-D16		KGN1584A	KIT RACCORD CORNIERE D30-D16	<table border="1"> <thead> <tr> <th>Code</th> <th>Description</th> <th>Qté</th> <th>UOM</th> </tr> </thead> <tbody> <tr> <td>GN1584A0</td> <td>CORNER FITTING D30-D16</td> <td>1.000</td> <td>PCS</td> </tr> </tbody> </table>	Code	Description	Qté	UOM	GN1584A0	CORNER FITTING D30-D16	1.000	PCS												
Code	Description	Qté	UOM																						
GN1584A0	CORNER FITTING D30-D16	1.000	PCS																						
RC1042A	DOUBLE WIRE SPRING CLAMP D21.5-22.6		KTB3074B	KIT TUYAU CONNECTEUR VENTURI XEVC-0711-G	<table border="1"> <thead> <tr> <th>Code</th> <th>Description</th> <th>Qté</th> <th>UOM</th> </tr> </thead> <tbody> <tr> <td>GN1544A0</td> <td>JOINT ENTREE AIR</td> <td>1.000</td> <td>PCS</td> </tr> <tr> <td>GN1584A0</td> <td>CORNER FITTING D30-D16</td> <td>1.000</td> <td>PCS</td> </tr> <tr> <td>RC1042A0</td> <td>DOUBLE WIRE SPRING CLAMP D21.5-22.6</td> <td>1.000</td> <td>PCS</td> </tr> </tbody> </table>	Code	Description	Qté	UOM	GN1544A0	JOINT ENTREE AIR	1.000	PCS	GN1584A0	CORNER FITTING D30-D16	1.000	PCS	RC1042A0	DOUBLE WIRE SPRING CLAMP D21.5-22.6	1.000	PCS				
Code	Description	Qté	UOM																						
GN1544A0	JOINT ENTREE AIR	1.000	PCS																						
GN1584A0	CORNER FITTING D30-D16	1.000	PCS																						
RC1042A0	DOUBLE WIRE SPRING CLAMP D21.5-22.6	1.000	PCS																						

COMPOSANT			PIÈCE DE RECHANGE																								
Code	Description	Image	Code	Description	Composants du kit																						
RC1042A	DOUBLE WIRE SPRING CLAMP D21.5-22.6		KTB3074B	KIT TUYAU CONNECTEUR VENTURI XEVC-0711-G	<table border="1"> <thead> <tr> <th>Code</th> <th>Description</th> <th>Qté</th> <th>UOM</th> </tr> </thead> <tbody> <tr> <td>TB3074B0</td> <td>TUBE D.30 CAPTEUR VENTURI XEVC-07EU-G</td> <td>1.000</td> <td>PCS</td> </tr> <tr> <td>VM1794A0</td> <td>PLAQUETTE NOIRE 250X4.8 PA66</td> <td>1.000</td> <td>PCS</td> </tr> </tbody> </table>	Code	Description	Qté	UOM	TB3074B0	TUBE D.30 CAPTEUR VENTURI XEVC-07EU-G	1.000	PCS	VM1794A0	PLAQUETTE NOIRE 250X4.8 PA66	1.000	PCS										
					Code	Description	Qté	UOM																			
					TB3074B0	TUBE D.30 CAPTEUR VENTURI XEVC-07EU-G	1.000	PCS																			
					VM1794A0	PLAQUETTE NOIRE 250X4.8 PA66	1.000	PCS																			
			<table border="1"> <thead> <tr> <th>Code</th> <th>Description</th> <th>Qté</th> <th>UOM</th> </tr> </thead> <tbody> <tr> <td>GN1544A0</td> <td>JOINT ENTREE AIR</td> <td>2.000</td> <td>PCS</td> </tr> <tr> <td>GN1584A0</td> <td>CORNER FITTING D30-D16</td> <td>1.000</td> <td>PCS</td> </tr> <tr> <td>RC1042A0</td> <td>DOUBLE WIRE SPRING CLAMP D21.5-22.6</td> <td>1.000</td> <td>PCS</td> </tr> <tr> <td>TB3068B0</td> <td>XEBC-10 VENTURI AIR COLLECTOR PIPE D30</td> <td>1.000</td> <td>PCS</td> </tr> <tr> <td>VM1794A0</td> <td>PLAQUETTE NOIRE 250X4.8 PA66</td> <td>1.000</td> <td>PCS</td> </tr> </tbody> </table>	Code	Description	Qté	UOM	GN1544A0	JOINT ENTREE AIR	2.000	PCS	GN1584A0	CORNER FITTING D30-D16	1.000	PCS	RC1042A0	DOUBLE WIRE SPRING CLAMP D21.5-22.6	1.000	PCS	TB3068B0	XEBC-10 VENTURI AIR COLLECTOR PIPE D30	1.000	PCS	VM1794A0	PLAQUETTE NOIRE 250X4.8 PA66	1.000	PCS
			Code	Description	Qté	UOM																					
			GN1544A0	JOINT ENTREE AIR	2.000	PCS																					
			GN1584A0	CORNER FITTING D30-D16	1.000	PCS																					
			RC1042A0	DOUBLE WIRE SPRING CLAMP D21.5-22.6	1.000	PCS																					
			TB3068B0	XEBC-10 VENTURI AIR COLLECTOR PIPE D30	1.000	PCS																					
			VM1794A0	PLAQUETTE NOIRE 250X4.8 PA66	1.000	PCS																					
			KTB3068B	KIT TUYAU CONNECT. VENTURI 10FS/EU/21-G	<table border="1"> <thead> <tr> <th>Code</th> <th>Description</th> <th>Qté</th> <th>UOM</th> </tr> </thead> <tbody> <tr> <td>GN1544A0</td> <td>JOINT ENTREE AIR</td> <td>1.000</td> <td>PCS</td> </tr> <tr> <td>GN1584A0</td> <td>CORNER FITTING D30-D16</td> <td>1.000</td> <td>PCS</td> </tr> <tr> <td>RC1042A0</td> <td>DOUBLE WIRE SPRING CLAMP D21.5-22.6</td> <td>1.000</td> <td>PCS</td> </tr> <tr> <td>TB3068B0</td> <td>XEBC-10 VENTURI AIR COLLECTOR PIPE D30</td> <td>1.000</td> <td>PCS</td> </tr> <tr> <td>VM1794A0</td> <td>PLAQUETTE NOIRE 250X4.8 PA66</td> <td>1.000</td> <td>PCS</td> </tr> </tbody> </table>	Code	Description	Qté	UOM	GN1544A0	JOINT ENTREE AIR	1.000	PCS	GN1584A0	CORNER FITTING D30-D16	1.000	PCS	RC1042A0	DOUBLE WIRE SPRING CLAMP D21.5-22.6	1.000	PCS	TB3068B0	XEBC-10 VENTURI AIR COLLECTOR PIPE D30	1.000	PCS	VM1794A0	PLAQUETTE NOIRE 250X4.8 PA66
Code	Description	Qté			UOM																						
GN1544A0	JOINT ENTREE AIR	1.000			PCS																						
GN1584A0	CORNER FITTING D30-D16	1.000			PCS																						
RC1042A0	DOUBLE WIRE SPRING CLAMP D21.5-22.6	1.000	PCS																								
TB3068B0	XEBC-10 VENTURI AIR COLLECTOR PIPE D30	1.000	PCS																								
VM1794A0	PLAQUETTE NOIRE 250X4.8 PA66	1.000	PCS																								
KTB3019A	KIT TUYAU CONNECT VENTURI SUP 20XX/16XX	<table border="1"> <thead> <tr> <th>Code</th> <th>Description</th> <th>Qté</th> <th>UOM</th> </tr> </thead> <tbody> <tr> <td>GN1544A0</td> <td>JOINT ENTREE AIR</td> <td>1.000</td> <td>PCS</td> </tr> <tr> <td>GN1584A0</td> <td>CORNER FITTING D30-D16</td> <td>1.000</td> <td>PCS</td> </tr> <tr> <td>RC1042A0</td> <td>DOUBLE WIRE SPRING CLAMP D21.5-22.6</td> <td>1.000</td> <td>PCS</td> </tr> <tr> <td>TB3019A1</td> <td>XEVC-2011 UPPER AIR INLET PIPE D3</td> <td>1.000</td> <td>PCS</td> </tr> <tr> <td>VM1794A0</td> <td>PLAQUETTE NOIRE 250X4.8 PA66</td> <td>1.000</td> <td>PCS</td> </tr> </tbody> </table>	Code	Description	Qté	UOM	GN1544A0	JOINT ENTREE AIR	1.000	PCS	GN1584A0	CORNER FITTING D30-D16	1.000	PCS	RC1042A0	DOUBLE WIRE SPRING CLAMP D21.5-22.6	1.000	PCS	TB3019A1	XEVC-2011 UPPER AIR INLET PIPE D3	1.000	PCS	VM1794A0	PLAQUETTE NOIRE 250X4.8 PA66	1.000	PCS	
		Code	Description	Qté	UOM																						
		GN1544A0	JOINT ENTREE AIR	1.000	PCS																						
		GN1584A0	CORNER FITTING D30-D16	1.000	PCS																						
RC1042A0	DOUBLE WIRE SPRING CLAMP D21.5-22.6	1.000	PCS																								
TB3019A1	XEVC-2011 UPPER AIR INLET PIPE D3	1.000	PCS																								
VM1794A0	PLAQUETTE NOIRE 250X4.8 PA66	1.000	PCS																								
KTB2979C	KIT TUYAU CONNECTEUR VENTURI XEBC-10XX-E	<table border="1"> <thead> <tr> <th>Code</th> <th>Description</th> <th>Qté</th> <th>UOM</th> </tr> </thead> <tbody> <tr> <td>GN1544A0</td> <td>JOINT ENTREE AIR</td> <td>2.000</td> <td>PCS</td> </tr> <tr> <td>GN1584A0</td> <td>CORNER FITTING D30-D16</td> <td>1.000</td> <td>PCS</td> </tr> <tr> <td>RC1042A0</td> <td>DOUBLE WIRE SPRING CLAMP D21.5-22.6</td> <td>1.000</td> <td>PCS</td> </tr> </tbody> </table>	Code	Description	Qté	UOM	GN1544A0	JOINT ENTREE AIR	2.000	PCS	GN1584A0	CORNER FITTING D30-D16	1.000	PCS	RC1042A0	DOUBLE WIRE SPRING CLAMP D21.5-22.6	1.000	PCS									
		Code	Description	Qté	UOM																						
		GN1544A0	JOINT ENTREE AIR	2.000	PCS																						
		GN1584A0	CORNER FITTING D30-D16	1.000	PCS																						
RC1042A0	DOUBLE WIRE SPRING CLAMP D21.5-22.6	1.000	PCS																								

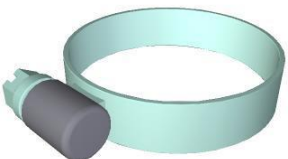

COMPOSANT			PIÈCE DE RECHANGE																							
Code	Description	Image	Code	Description	Composants du kit																					
RC1042A	DOUBLE WIRE SPRING CLAMP D21.5-22.6		KTB2979C	KIT TUYAU CONNECTEUR VENTURI XEBC-10XX-E	<table border="1"> <thead> <tr> <th>Code</th> <th>Description</th> <th>Qté</th> <th>UOM</th> </tr> </thead> <tbody> <tr> <td>TB2979C0</td> <td>XEBC-10 VENTURI AIR COLLECTOR PIPE D30</td> <td>1.000</td> <td>PCS</td> </tr> <tr> <td>VM1794A0</td> <td>PLAQUETTE NOIRE 250X4.8 PA66</td> <td>1.000</td> <td>PCS</td> </tr> </tbody> </table>	Code	Description	Qté	UOM	TB2979C0	XEBC-10 VENTURI AIR COLLECTOR PIPE D30	1.000	PCS	VM1794A0	PLAQUETTE NOIRE 250X4.8 PA66	1.000	PCS									
			Code	Description	Qté	UOM																				
			TB2979C0	XEBC-10 VENTURI AIR COLLECTOR PIPE D30	1.000	PCS																				
			VM1794A0	PLAQUETTE NOIRE 250X4.8 PA66	1.000	PCS																				
KTB2978B	KIT TUYAU CONNECTEUR VENTURI 06EU/FS/2	<table border="1"> <thead> <tr> <th>Code</th> <th>Description</th> <th>Qté</th> <th>UOM</th> </tr> </thead> <tbody> <tr> <td>GN1544A0</td> <td>JOINT ENTREE AIR</td> <td>1.000</td> <td>PCS</td> </tr> <tr> <td>GN1584A0</td> <td>CORNER FITTING D30-D16</td> <td>1.000</td> <td>PCS</td> </tr> <tr> <td>RC1042A0</td> <td>DOUBLE WIRE SPRING CLAMP D21.5-22.6</td> <td>1.000</td> <td>PCS</td> </tr> <tr> <td>TB2978B0</td> <td>XEBC-06 VENTURI AIR COLLECTOR PIPE D30</td> <td>1.000</td> <td>PCS</td> </tr> <tr> <td>VM1794A0</td> <td>PLAQUETTE NOIRE 250X4.8 PA66</td> <td>1.000</td> <td>PCS</td> </tr> </tbody> </table>	Code	Description	Qté	UOM	GN1544A0	JOINT ENTREE AIR	1.000	PCS	GN1584A0	CORNER FITTING D30-D16	1.000	PCS	RC1042A0	DOUBLE WIRE SPRING CLAMP D21.5-22.6	1.000	PCS	TB2978B0	XEBC-06 VENTURI AIR COLLECTOR PIPE D30	1.000	PCS	VM1794A0	PLAQUETTE NOIRE 250X4.8 PA66	1.000	PCS
Code	Description	Qté	UOM																							
GN1544A0	JOINT ENTREE AIR	1.000	PCS																							
GN1584A0	CORNER FITTING D30-D16	1.000	PCS																							
RC1042A0	DOUBLE WIRE SPRING CLAMP D21.5-22.6	1.000	PCS																							
TB2978B0	XEBC-06 VENTURI AIR COLLECTOR PIPE D30	1.000	PCS																							
VM1794A0	PLAQUETTE NOIRE 250X4.8 PA66	1.000	PCS																							
KTB2959B	KIT TUYAU CONNECTEUR VENTURI XEVC-1011-E	<table border="1"> <thead> <tr> <th>Code</th> <th>Description</th> <th>Qté</th> <th>UOM</th> </tr> </thead> <tbody> <tr> <td>GN1544A0</td> <td>JOINT ENTREE AIR</td> <td>2.000</td> <td>PCS</td> </tr> <tr> <td>GN1584A0</td> <td>CORNER FITTING D30-D16</td> <td>1.000</td> <td>PCS</td> </tr> <tr> <td>RC1042A0</td> <td>DOUBLE WIRE SPRING CLAMP D21.5-22.6</td> <td>1.000</td> <td>PCS</td> </tr> <tr> <td>TB2959B0</td> <td>XEVC-1011-E VENTURI PIPE</td> <td>1.000</td> <td>PCS</td> </tr> <tr> <td>VM1794A0</td> <td>PLAQUETTE NOIRE 250X4.8 PA66</td> <td>1.000</td> <td>PCS</td> </tr> </tbody> </table>	Code	Description	Qté	UOM	GN1544A0	JOINT ENTREE AIR	2.000	PCS	GN1584A0	CORNER FITTING D30-D16	1.000	PCS	RC1042A0	DOUBLE WIRE SPRING CLAMP D21.5-22.6	1.000	PCS	TB2959B0	XEVC-1011-E VENTURI PIPE	1.000	PCS	VM1794A0	PLAQUETTE NOIRE 250X4.8 PA66	1.000	PCS
Code	Description	Qté	UOM																							
GN1544A0	JOINT ENTREE AIR	2.000	PCS																							
GN1584A0	CORNER FITTING D30-D16	1.000	PCS																							
RC1042A0	DOUBLE WIRE SPRING CLAMP D21.5-22.6	1.000	PCS																							
TB2959B0	XEVC-1011-E VENTURI PIPE	1.000	PCS																							
VM1794A0	PLAQUETTE NOIRE 250X4.8 PA66	1.000	PCS																							
KTB2958B	KIT TUYAU CONNECTEUR VENTURI XEVC-0711-E	<table border="1"> <thead> <tr> <th>Code</th> <th>Description</th> <th>Qté</th> <th>UOM</th> </tr> </thead> <tbody> <tr> <td>GN1544A0</td> <td>JOINT ENTREE AIR</td> <td>1.000</td> <td>PCS</td> </tr> <tr> <td>GN1584A0</td> <td>CORNER FITTING D30-D16</td> <td>1.000</td> <td>PCS</td> </tr> <tr> <td>RC1042A0</td> <td>DOUBLE WIRE SPRING CLAMP D21.5-22.6</td> <td>1.000</td> <td>PCS</td> </tr> <tr> <td>TB2958B0</td> <td>XEVC-0711-E VENTURI PIPE</td> <td>1.000</td> <td>PCS</td> </tr> </tbody> </table>	Code	Description	Qté	UOM	GN1544A0	JOINT ENTREE AIR	1.000	PCS	GN1584A0	CORNER FITTING D30-D16	1.000	PCS	RC1042A0	DOUBLE WIRE SPRING CLAMP D21.5-22.6	1.000	PCS	TB2958B0	XEVC-0711-E VENTURI PIPE	1.000	PCS				
Code	Description	Qté	UOM																							
GN1544A0	JOINT ENTREE AIR	1.000	PCS																							
GN1584A0	CORNER FITTING D30-D16	1.000	PCS																							
RC1042A0	DOUBLE WIRE SPRING CLAMP D21.5-22.6	1.000	PCS																							
TB2958B0	XEVC-0711-E VENTURI PIPE	1.000	PCS																							

COMPOSANT			PIÈCE DE RECHANGE																										
Code	Description	Image	Code	Description	Composants du kit																								
RC1042A	DOUBLE WIRE SPRING CLAMP D21.5-22.6		KTB2957B	KIT TUYAU CONNECTEUR VENTURI 0511/04EU-E	<table border="1"> <thead> <tr> <th>Code</th> <th>Description</th> <th>Qté</th> <th>UOM</th> </tr> </thead> <tbody> <tr> <td>GN1544A0</td> <td>JOINT ENTREE AIR</td> <td>1.000</td> <td>PCS</td> </tr> <tr> <td>GN1584A0</td> <td>CORNER FITTING D30-D16</td> <td>1.000</td> <td>PCS</td> </tr> <tr> <td>RC1042A0</td> <td>DOUBLE WIRE SPRING CLAMP D21.5-22.6</td> <td>1.000</td> <td>PCS</td> </tr> <tr> <td>TB2957B0</td> <td>XEVC-0511-E VENTURI PIPE</td> <td>1.000</td> <td>PCS</td> </tr> <tr> <td>VM1794A0</td> <td>PLAQUETTE NOIRE 250X4.8 PA66</td> <td>1.000</td> <td>PCS</td> </tr> </tbody> </table>	Code	Description	Qté	UOM	GN1544A0	JOINT ENTREE AIR	1.000	PCS	GN1584A0	CORNER FITTING D30-D16	1.000	PCS	RC1042A0	DOUBLE WIRE SPRING CLAMP D21.5-22.6	1.000	PCS	TB2957B0	XEVC-0511-E VENTURI PIPE	1.000	PCS	VM1794A0	PLAQUETTE NOIRE 250X4.8 PA66	1.000	PCS
			Code	Description	Qté	UOM																							
			GN1544A0	JOINT ENTREE AIR	1.000	PCS																							
GN1584A0	CORNER FITTING D30-D16	1.000	PCS																										
RC1042A0	DOUBLE WIRE SPRING CLAMP D21.5-22.6	1.000	PCS																										
TB2957B0	XEVC-0511-E VENTURI PIPE	1.000	PCS																										
VM1794A0	PLAQUETTE NOIRE 250X4.8 PA66	1.000	PCS																										
KTB2956A	KIT TUYAU CONNECTEUR VENTURI XEVC-0311-E	<table border="1"> <thead> <tr> <th>Code</th> <th>Description</th> <th>Qté</th> <th>UOM</th> </tr> </thead> <tbody> <tr> <td>GN1544A0</td> <td>JOINT ENTREE AIR</td> <td>1.000</td> <td>PCS</td> </tr> <tr> <td>RC1042A0</td> <td>DOUBLE WIRE SPRING CLAMP D21.5-22.6</td> <td>1.000</td> <td>PCS</td> </tr> <tr> <td>TB2956A0</td> <td>XEVC-0311-E VENTURI PIPE</td> <td>1.000</td> <td>PCS</td> </tr> </tbody> </table>	Code	Description	Qté	UOM	GN1544A0	JOINT ENTREE AIR	1.000	PCS	RC1042A0	DOUBLE WIRE SPRING CLAMP D21.5-22.6	1.000	PCS	TB2956A0	XEVC-0311-E VENTURI PIPE	1.000	PCS											
Code	Description	Qté	UOM																										
GN1544A0	JOINT ENTREE AIR	1.000	PCS																										
RC1042A0	DOUBLE WIRE SPRING CLAMP D21.5-22.6	1.000	PCS																										
TB2956A0	XEVC-0311-E VENTURI PIPE	1.000	PCS																										
KTB2944A	KIT TUYAU CONNECT VENTURI INF 20XX/16XX	<table border="1"> <thead> <tr> <th>Code</th> <th>Description</th> <th>Qté</th> <th>UOM</th> </tr> </thead> <tbody> <tr> <td>GN1544A0</td> <td>JOINT ENTREE AIR</td> <td>2.000</td> <td>PCS</td> </tr> <tr> <td>GN1584A0</td> <td>CORNER FITTING D30-D16</td> <td>1.000</td> <td>PCS</td> </tr> <tr> <td>RC1042A0</td> <td>DOUBLE WIRE SPRING CLAMP D21.5-22.6</td> <td>1.000</td> <td>PCS</td> </tr> <tr> <td>TB2944A1</td> <td>XEVC-2011 AIR INLET PIPE D3</td> <td>1.000</td> <td>PCS</td> </tr> <tr> <td>VM1794A0</td> <td>PLAQUETTE NOIRE 250X4.8 PA66</td> <td>1.000</td> <td>PCS</td> </tr> </tbody> </table>	Code	Description	Qté	UOM	GN1544A0	JOINT ENTREE AIR	2.000	PCS	GN1584A0	CORNER FITTING D30-D16	1.000	PCS	RC1042A0	DOUBLE WIRE SPRING CLAMP D21.5-22.6	1.000	PCS	TB2944A1	XEVC-2011 AIR INLET PIPE D3	1.000	PCS	VM1794A0	PLAQUETTE NOIRE 250X4.8 PA66	1.000	PCS			
Code	Description	Qté	UOM																										
GN1544A0	JOINT ENTREE AIR	2.000	PCS																										
GN1584A0	CORNER FITTING D30-D16	1.000	PCS																										
RC1042A0	DOUBLE WIRE SPRING CLAMP D21.5-22.6	1.000	PCS																										
TB2944A1	XEVC-2011 AIR INLET PIPE D3	1.000	PCS																										
VM1794A0	PLAQUETTE NOIRE 250X4.8 PA66	1.000	PCS																										
KRC1042A	10PCS CLAMP BIFIL SPRING D21.5-22.6 KIT	<table border="1"> <thead> <tr> <th>Code</th> <th>Description</th> <th>Qté</th> <th>UOM</th> </tr> </thead> <tbody> <tr> <td>RC1042A0</td> <td>DOUBLE WIRE SPRING CLAMP D21.5-22.6</td> <td>10.000</td> <td>PCS</td> </tr> </tbody> </table>	Code	Description	Qté	UOM	RC1042A0	DOUBLE WIRE SPRING CLAMP D21.5-22.6	10.000	PCS																			
Code	Description	Qté	UOM																										
RC1042A0	DOUBLE WIRE SPRING CLAMP D21.5-22.6	10.000	PCS																										

COMPOSANT			PIÈCE DE RECHANGE																			
Code	Description	Image	Code	Description	Composants du kit																	
RC1378A	PINCE DURITE		KVM2379A	KIT SYSTEME ACTUATEUR VENTURI MM 200V	<table border="1"> <thead> <tr> <th>Code</th> <th>Description</th> <th>Qté</th> <th>UOM</th> </tr> </thead> <tbody> <tr> <td>RC1378A0</td> <td>PINCE DURITE</td> <td>3.000</td> <td>PCS</td> </tr> <tr> <td>TB1520A0</td> <td>TUBE D.Int=30 Epais=4 GOMME EPDM NOIR</td> <td>0.120</td> <td>M</td> </tr> <tr> <td>VM2379A1</td> <td>ASSEMBLAGE VENTURI 200V 50/60 HZ</td> <td>1.000</td> <td>PCS</td> </tr> </tbody> </table>	Code	Description	Qté	UOM	RC1378A0	PINCE DURITE	3.000	PCS	TB1520A0	TUBE D.Int=30 Epais=4 GOMME EPDM NOIR	0.120	M	VM2379A1	ASSEMBLAGE VENTURI 200V 50/60 HZ	1.000	PCS	
			Code	Description	Qté	UOM																
			RC1378A0	PINCE DURITE	3.000	PCS																
			TB1520A0	TUBE D.Int=30 Epais=4 GOMME EPDM NOIR	0.120	M																
			VM2379A1	ASSEMBLAGE VENTURI 200V 50/60 HZ	1.000	PCS																
KVM2378A	KIT SYSTEME ACTUATEUR VENTURI 240V MM	<table border="1"> <thead> <tr> <th>Code</th> <th>Description</th> <th>Qté</th> <th>UOM</th> </tr> </thead> <tbody> <tr> <td>RC1378A0</td> <td>PINCE DURITE</td> <td>3.000</td> <td>PCS</td> </tr> <tr> <td>TB1520A0</td> <td>TUBE D.Int=30 Epais=4 GOMME EPDM NOIR</td> <td>0.120</td> <td>M</td> </tr> <tr> <td>VM2378A1</td> <td>ASSEMBLAGE VENTURI 240V 50/60 HZ UL</td> <td>1.000</td> <td>PCS</td> </tr> </tbody> </table>	Code	Description	Qté	UOM	RC1378A0	PINCE DURITE	3.000	PCS	TB1520A0	TUBE D.Int=30 Epais=4 GOMME EPDM NOIR	0.120	M	VM2378A1	ASSEMBLAGE VENTURI 240V 50/60 HZ UL	1.000	PCS				
Code	Description	Qté	UOM																			
RC1378A0	PINCE DURITE	3.000	PCS																			
TB1520A0	TUBE D.Int=30 Epais=4 GOMME EPDM NOIR	0.120	M																			
VM2378A1	ASSEMBLAGE VENTURI 240V 50/60 HZ UL	1.000	PCS																			
KVM2377A	KIT SYSTEME ACTUATEUR VENTURI MM 220V	<table border="1"> <thead> <tr> <th>Code</th> <th>Description</th> <th>Qté</th> <th>UOM</th> </tr> </thead> <tbody> <tr> <td>RC1378A0</td> <td>PINCE DURITE</td> <td>3.000</td> <td>PCS</td> </tr> <tr> <td>TB1520A0</td> <td>TUBE D.Int=30 Epais=4 GOMME EPDM NOIR</td> <td>0.120</td> <td>M</td> </tr> <tr> <td>VM2377A1</td> <td>ASSEMBLAGE VENTURI 220V 50/60 HZ</td> <td>1.000</td> <td>PCS</td> </tr> </tbody> </table>	Code	Description	Qté	UOM	RC1378A0	PINCE DURITE	3.000	PCS	TB1520A0	TUBE D.Int=30 Epais=4 GOMME EPDM NOIR	0.120	M	VM2377A1	ASSEMBLAGE VENTURI 220V 50/60 HZ	1.000	PCS				
Code	Description	Qté	UOM																			
RC1378A0	PINCE DURITE	3.000	PCS																			
TB1520A0	TUBE D.Int=30 Epais=4 GOMME EPDM NOIR	0.120	M																			
VM2377A1	ASSEMBLAGE VENTURI 220V 50/60 HZ	1.000	PCS																			
KVE1140A	KIT BOBINE VENTURI S.5/5E JAPAN	<table border="1"> <thead> <tr> <th>Code</th> <th>Description</th> <th>Qté</th> <th>UOM</th> </tr> </thead> <tbody> <tr> <td>RC1378A0</td> <td>PINCE DURITE</td> <td>2.000</td> <td>PCS</td> </tr> <tr> <td>TB1520A0</td> <td>TUBE D.Int=30 Epais=4 GOMME EPDM NOIR</td> <td>0.050</td> <td>M</td> </tr> <tr> <td>VI1220A1</td> <td>VIS AUTOTARADE UX 4.2x12 TCB MARUTEX PRE</td> <td>1.000</td> <td>PCS</td> </tr> <tr> <td>VM2632A0</td> <td></td> <td>1.000</td> <td>PCS</td> </tr> </tbody> </table>	Code	Description	Qté	UOM	RC1378A0	PINCE DURITE	2.000	PCS	TB1520A0	TUBE D.Int=30 Epais=4 GOMME EPDM NOIR	0.050	M	VI1220A1	VIS AUTOTARADE UX 4.2x12 TCB MARUTEX PRE	1.000	PCS	VM2632A0		1.000	PCS
Code	Description	Qté	UOM																			
RC1378A0	PINCE DURITE	2.000	PCS																			
TB1520A0	TUBE D.Int=30 Epais=4 GOMME EPDM NOIR	0.050	M																			
VI1220A1	VIS AUTOTARADE UX 4.2x12 TCB MARUTEX PRE	1.000	PCS																			
VM2632A0		1.000	PCS																			
KVE1014A	KIT BOBINE VENTURI S.5 120V	<table border="1"> <thead> <tr> <th>Code</th> <th>Description</th> <th>Qté</th> <th>UOM</th> </tr> </thead> <tbody> <tr> <td>RC1378A0</td> <td>PINCE DURITE</td> <td>2.000</td> <td>PCS</td> </tr> <tr> <td>TB1520A0</td> <td>TUBE D.Int=30 Epais=4 GOMME EPDM NOIR</td> <td>0.050</td> <td>M</td> </tr> <tr> <td>VM2633A0</td> <td></td> <td>1.000</td> <td>PCS</td> </tr> </tbody> </table>	Code	Description	Qté	UOM	RC1378A0	PINCE DURITE	2.000	PCS	TB1520A0	TUBE D.Int=30 Epais=4 GOMME EPDM NOIR	0.050	M	VM2633A0		1.000	PCS				
Code	Description	Qté	UOM																			
RC1378A0	PINCE DURITE	2.000	PCS																			
TB1520A0	TUBE D.Int=30 Epais=4 GOMME EPDM NOIR	0.050	M																			
VM2633A0		1.000	PCS																			
KRC1378A	KIT 10PCS COLLIER DE TUYAU	<table border="1"> <thead> <tr> <th>Code</th> <th>Description</th> <th>Qté</th> <th>UOM</th> </tr> </thead> <tbody> <tr> <td>RC1378A0</td> <td>PINCE DURITE</td> <td>10.000</td> <td>PCS</td> </tr> </tbody> </table>	Code	Description	Qté	UOM	RC1378A0	PINCE DURITE	10.000	PCS												
Code	Description	Qté	UOM																			
RC1378A0	PINCE DURITE	10.000	PCS																			

COMPOSANT			PIÈCE DE RECHANGE																						
Code	Description	Image	Code	Description	Composants du kit																				
TB1956A	TB1520A-GREY SILICONE PIPE L=0,04M		KTB1002A	KIT TUBE EPDM NOIR 240MT TB1520	<table border="1"> <thead> <tr> <th>Code</th> <th>Description</th> <th>Qté</th> <th>UOM</th> </tr> </thead> <tbody> <tr> <td>TB1520A0</td> <td>TUBE D.Int=30 Epais=4 GOMME EPDM NOIR</td> <td>240.000</td> <td>M</td> </tr> </tbody> </table>	Code	Description	Qté	UOM	TB1520A0	TUBE D.Int=30 Epais=4 GOMME EPDM NOIR	240.000	M												
			Code	Description	Qté	UOM																			
			TB1520A0	TUBE D.Int=30 Epais=4 GOMME EPDM NOIR	240.000	M																			
KTB1001A	KIT TUBE EPDM NOIR 10MT TB1520A	<table border="1"> <thead> <tr> <th>Code</th> <th>Description</th> <th>Qté</th> <th>UOM</th> </tr> </thead> <tbody> <tr> <td>TB1520A0</td> <td>TUBE D.Int=30 Epais=4 GOMME EPDM NOIR</td> <td>10.000</td> <td>M</td> </tr> <tr> <td>VM1794A0</td> <td>PLAQUETTE NOIRE 250X4.8 PA66</td> <td>3.000</td> <td>PCS</td> </tr> </tbody> </table>	Code	Description	Qté	UOM	TB1520A0	TUBE D.Int=30 Epais=4 GOMME EPDM NOIR	10.000	M	VM1794A0	PLAQUETTE NOIRE 250X4.8 PA66	3.000	PCS											
Code	Description	Qté	UOM																						
TB1520A0	TUBE D.Int=30 Epais=4 GOMME EPDM NOIR	10.000	M																						
VM1794A0	PLAQUETTE NOIRE 250X4.8 PA66	3.000	PCS																						
KTB1000A	KIT TUYAU EPDM NOIR 2MT TB1520A	<table border="1"> <thead> <tr> <th>Code</th> <th>Description</th> <th>Qté</th> <th>UOM</th> </tr> </thead> <tbody> <tr> <td>RC1055A0</td> <td>COLLIER DE SERRAGE TUBE MÉTALLIQUE</td> <td>2.000</td> <td>PCS</td> </tr> <tr> <td>TB1520A0</td> <td>TUBE D.Int=30 Epais=4 GOMME EPDM NOIR</td> <td>2.000</td> <td>M</td> </tr> </tbody> </table>	Code	Description	Qté	UOM	RC1055A0	COLLIER DE SERRAGE TUBE MÉTALLIQUE	2.000	PCS	TB1520A0	TUBE D.Int=30 Epais=4 GOMME EPDM NOIR	2.000	M											
Code	Description	Qté	UOM																						
RC1055A0	COLLIER DE SERRAGE TUBE MÉTALLIQUE	2.000	PCS																						
TB1520A0	TUBE D.Int=30 Epais=4 GOMME EPDM NOIR	2.000	M																						
TB2958B	XEVC-0711-E VENTURI PIPE		KTB2958B	KIT TUYAU CONNECTEUR VENTURI XEVC-0711-E	<table border="1"> <thead> <tr> <th>Code</th> <th>Description</th> <th>Qté</th> <th>UOM</th> </tr> </thead> <tbody> <tr> <td>GN1544A0</td> <td>JOINT ENTREE AIR</td> <td>1.000</td> <td>PCS</td> </tr> <tr> <td>GN1584A0</td> <td>CORNER FITTING D30-D16</td> <td>1.000</td> <td>PCS</td> </tr> <tr> <td>RC1042A0</td> <td>DOUBLE WIRE SPRING CLAMP D21.5-22.6</td> <td>1.000</td> <td>PCS</td> </tr> <tr> <td>TB2958B0</td> <td>XEVC-0711-E VENTURI PIPE</td> <td>1.000</td> <td>PCS</td> </tr> </tbody> </table>	Code	Description	Qté	UOM	GN1544A0	JOINT ENTREE AIR	1.000	PCS	GN1584A0	CORNER FITTING D30-D16	1.000	PCS	RC1042A0	DOUBLE WIRE SPRING CLAMP D21.5-22.6	1.000	PCS	TB2958B0	XEVC-0711-E VENTURI PIPE	1.000	PCS
			Code	Description	Qté	UOM																			
			GN1544A0	JOINT ENTREE AIR	1.000	PCS																			
			GN1584A0	CORNER FITTING D30-D16	1.000	PCS																			
RC1042A0	DOUBLE WIRE SPRING CLAMP D21.5-22.6	1.000	PCS																						
TB2958B0	XEVC-0711-E VENTURI PIPE	1.000	PCS																						
VM2377A	ENSEMBLE VENTURI 220V50/60 HZ		KVM2377A	KIT SYSTEME ACTUATEUR VENTURI MM 220V	<table border="1"> <thead> <tr> <th>Code</th> <th>Description</th> <th>Qté</th> <th>UOM</th> </tr> </thead> <tbody> <tr> <td>RC1378A0</td> <td>PINCE DURITE</td> <td>3.000</td> <td>PCS</td> </tr> <tr> <td>TB1520A0</td> <td>TUBE D.Int=30 Epais=4 GOMME EPDM NOIR</td> <td>0.120</td> <td>M</td> </tr> <tr> <td>VM2377A1</td> <td>ASSEMBLAGE VENTURI 220V 50/60 HZ</td> <td>1.000</td> <td>PCS</td> </tr> </tbody> </table>	Code	Description	Qté	UOM	RC1378A0	PINCE DURITE	3.000	PCS	TB1520A0	TUBE D.Int=30 Epais=4 GOMME EPDM NOIR	0.120	M	VM2377A1	ASSEMBLAGE VENTURI 220V 50/60 HZ	1.000	PCS				
Code	Description	Qté	UOM																						
RC1378A0	PINCE DURITE	3.000	PCS																						
TB1520A0	TUBE D.Int=30 Epais=4 GOMME EPDM NOIR	0.120	M																						
VM2377A1	ASSEMBLAGE VENTURI 220V 50/60 HZ	1.000	PCS																						

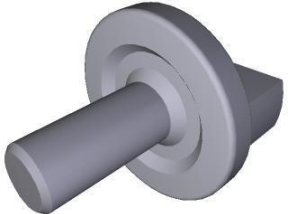
COMPOSANT			PIÈCE DE RECHANGE														
Code	Description	Image	Code	Description	Composants du kit												
VL1127A	RACCORD T BARBED 6mm		KVL1127A	KIT 10 PCS RACCORD T BARBED 6mm	<table border="1"> <thead> <tr> <th>Code</th> <th>Description</th> <th>Qté</th> <th>UOM</th> </tr> </thead> <tbody> <tr> <td>VL1127A1</td> <td>RACCORD T BARBED 6mm</td> <td>10.000</td> <td>PCS</td> </tr> </tbody> </table>	Code	Description	Qté	UOM	VL1127A1	RACCORD T BARBED 6mm	10.000	PCS				
Code	Description	Qté	UOM														
VL1127A1	RACCORD T BARBED 6mm	10.000	PCS														
RC1170A	ÉCROU M=14 H=7 CH=22 INOX		KRC1170A	KIT 10 ECROUS M14 H8 CH22 INOX	<table border="1"> <thead> <tr> <th>Code</th> <th>Description</th> <th>Qté</th> <th>UOM</th> </tr> </thead> <tbody> <tr> <td>RC1170A1</td> <td>ÉCROU M=14 H=7 CH=22 INOX</td> <td>10.000</td> <td>PCS</td> </tr> </tbody> </table>	Code	Description	Qté	UOM	RC1170A1	ÉCROU M=14 H=7 CH=22 INOX	10.000	PCS				
Code	Description	Qté	UOM														
RC1170A1	ÉCROU M=14 H=7 CH=22 INOX	10.000	PCS														
TB2937B	TUBE EXT HUMIDITE D10 AVEC RACCORD XEBC		TB3429A0	TUBE EXT HUMID D10 AVEC RACCORD XEVL EL													
TB3253A	TB3131A-T SHAPED EXT HUM PIPE CONNECTION		KTB3131A	KIT TUYAU REINF EPDM BLANC-NOIR 6X12 3M	<table border="1"> <thead> <tr> <th>Code</th> <th>Description</th> <th>Qté</th> <th>UOM</th> </tr> </thead> <tbody> <tr> <td>TB3131A0</td> <td>WHITE-BLACK EPDM TEXTILE BRAID HOSE 6x12</td> <td>3.000</td> <td>M</td> </tr> <tr> <td>VM1794A0</td> <td>PLAQUETTE NOIRE 250X4.8 PA66</td> <td>1.000</td> <td>PCS</td> </tr> </tbody> </table>	Code	Description	Qté	UOM	TB3131A0	WHITE-BLACK EPDM TEXTILE BRAID HOSE 6x12	3.000	M	VM1794A0	PLAQUETTE NOIRE 250X4.8 PA66	1.000	PCS
Code	Description	Qté	UOM														
TB3131A0	WHITE-BLACK EPDM TEXTILE BRAID HOSE 6x12	3.000	M														
VM1794A0	PLAQUETTE NOIRE 250X4.8 PA66	1.000	PCS														
GN1564A	0711 DOOR GASKET - GN1006A		KG1630A	KIT JOINT DE PORTE 0711	<table border="1"> <thead> <tr> <th>Code</th> <th>Description</th> <th>Qté</th> <th>UOM</th> </tr> </thead> <tbody> <tr> <td>GN1630A0</td> <td>GN1626A-JOIN T DE PORTE 0711 2320MM</td> <td>1.000</td> <td>PCS</td> </tr> <tr> <td>VM2277A0</td> <td>JONCTION INTERNE JOINT DE PORTE</td> <td>1.000</td> <td>PCS</td> </tr> </tbody> </table>	Code	Description	Qté	UOM	GN1630A0	GN1626A-JOIN T DE PORTE 0711 2320MM	1.000	PCS	VM2277A0	JONCTION INTERNE JOINT DE PORTE	1.000	PCS
Code	Description	Qté	UOM														
GN1630A0	GN1626A-JOIN T DE PORTE 0711 2320MM	1.000	PCS														
VM2277A0	JONCTION INTERNE JOINT DE PORTE	1.000	PCS														

COMPOSANT			PIÈCE DE RECHANGE										
Code	Description	Image	Code	Description	Composants du kit								
VL1037A	WASHING SYSTEM ROTOR ARM		KVL1037A	KIT RECHANGE TOURNIQUET LAVAGE	<table border="1"> <thead> <tr> <th>Code</th> <th>Description</th> <th>Qté</th> <th>UOM</th> </tr> </thead> <tbody> <tr> <td>VL1037A3</td> <td>SYSTEME LAVAGE 1 BRA</td> <td>1.000</td> <td>PCS</td> </tr> </tbody> </table>	Code	Description	Qté	UOM	VL1037A3	SYSTEME LAVAGE 1 BRA	1.000	PCS
Code	Description	Qté	UOM										
VL1037A3	SYSTEME LAVAGE 1 BRA	1.000	PCS										
VM1820A	LATERAL SUPPORTS M6 FIXING BOLT		KVM1820A	KIT 10 VIS	<table border="1"> <thead> <tr> <th>Code</th> <th>Description</th> <th>Qté</th> <th>UOM</th> </tr> </thead> <tbody> <tr> <td>VM1820A0</td> <td>LATERAL SUPPORTS M6 FIXING BOLT</td> <td>10.000</td> <td>PCS</td> </tr> </tbody> </table>	Code	Description	Qté	UOM	VM1820A0	LATERAL SUPPORTS M6 FIXING BOLT	10.000	PCS
Code	Description	Qté	UOM										
VM1820A0	LATERAL SUPPORTS M6 FIXING BOLT	10.000	PCS										
VM2331A	FAN GUARD-TRAYS HOLDER PIN		KVM2331A	KIT 4PC FIXATION CARTER-SUPPORT PLAQUES	<table border="1"> <thead> <tr> <th>Code</th> <th>Description</th> <th>Qté</th> <th>UOM</th> </tr> </thead> <tbody> <tr> <td>VM2331A0</td> <td>FAN GUARD-TRAY S HOLDER PIN</td> <td>4.000</td> <td>PCS</td> </tr> </tbody> </table>	Code	Description	Qté	UOM	VM2331A0	FAN GUARD-TRAY S HOLDER PIN	4.000	PCS
Code	Description	Qté	UOM										
VM2331A0	FAN GUARD-TRAY S HOLDER PIN	4.000	PCS										

ASM2917A/0.D01 - Couverture extérieure - FACE AVANT



ASM2917A/0.D01 - Couverture extérieure - ARRIÈRE

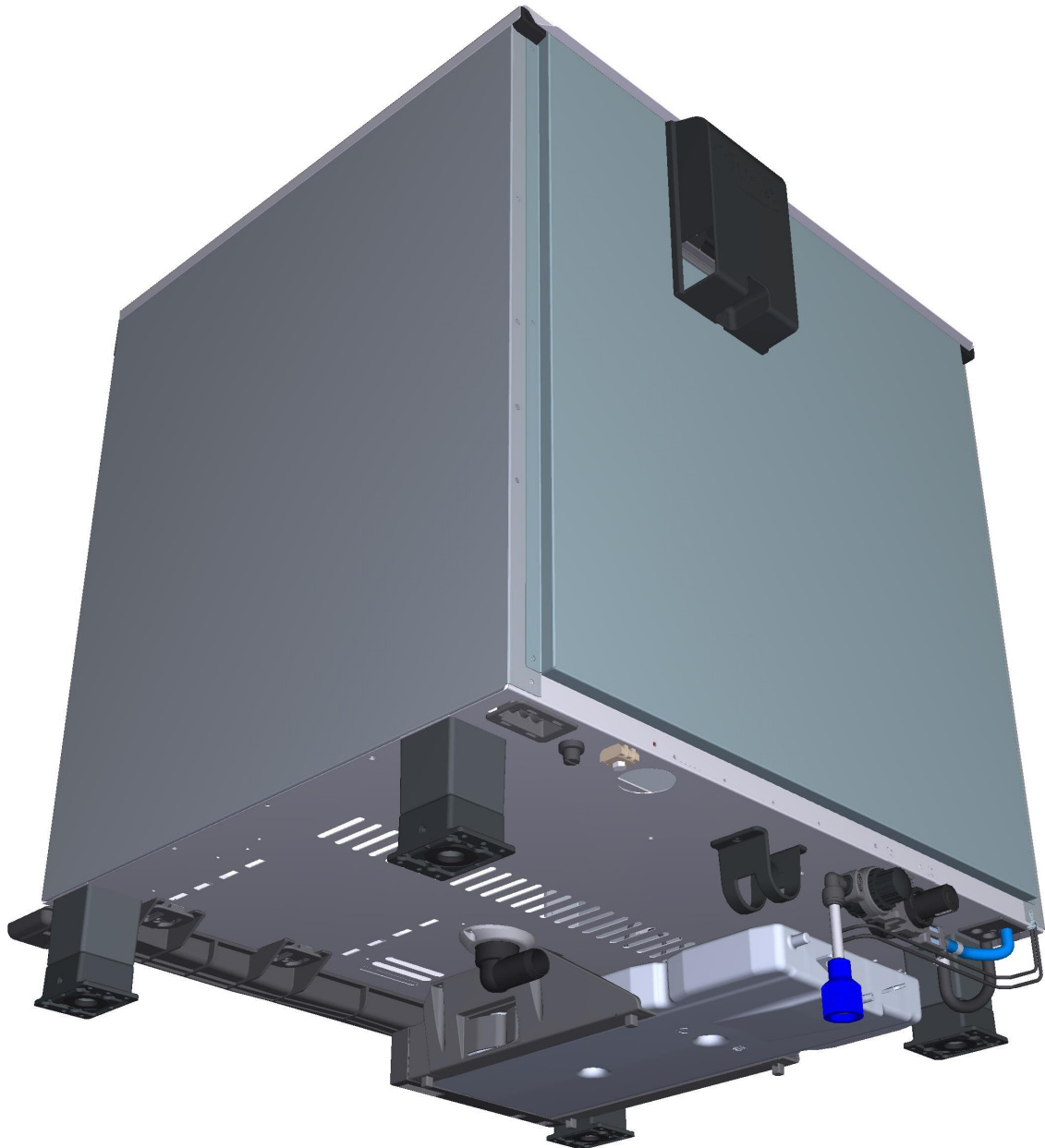





COMPOSANT			PIÈCE DE RECHANGE		
Code	Description	Image	Code	Description	Composants du kit
0D2295A	COUVERCLE HEVC GN1-1		0D2295A0	COUVERCLE HEVC GN1-1	
0D2300A	COTE GAUCHE XEVC-0711		0D2300A2	COTE GAUCHE XEVC-0711	
0D2301A	COTE DROIT XEVC-0711		0D2301A2	COTE DROIT XEVC-0711	
0E1350B	FOND EXTERIEUR XEVC GN1-1		0E1350B0	FOND EXTERIEUR XEVC GN1-1	
0F1497A	PANNEAU POSTERIEUR XEVC-0711-E		0F1497A0	PANNEAU POSTERIEUR XEVC-0711-E	

COMPOSANT			PIÈCE DE RECHANGE																																	
Code	Description	Image	Code	Description	Composants du kit																															
0H7291A	CHIMNEY HOLDING DISC		KVP1168A	KIT D'ANNEAU D'ÉTANCHÉITÉ POUR CHEMINÉE	<table border="1"> <thead> <tr> <th>Code</th> <th>Description</th> <th>Qté</th> <th>UOM</th> </tr> </thead> <tbody> <tr> <td>VI1220A1</td> <td>VIS AUTOTARADE UX 4.2x12 TCB MARUTEX PRE</td> <td>3.000</td> <td>PCS</td> </tr> <tr> <td>VP1168A0</td> <td>COLLET TENUE CHEMINEE</td> <td>1.000</td> <td>PCS</td> </tr> </tbody> </table>	Code	Description	Qté	UOM	VI1220A1	VIS AUTOTARADE UX 4.2x12 TCB MARUTEX PRE	3.000	PCS	VP1168A0	COLLET TENUE CHEMINEE	1.000	PCS																			
Code	Description	Qté	UOM																																	
VI1220A1	VIS AUTOTARADE UX 4.2x12 TCB MARUTEX PRE	3.000	PCS																																	
VP1168A0	COLLET TENUE CHEMINEE	1.000	PCS																																	
VM1190A	CT BT RIGHT DOOR SPRING LATCH		KVM1190A	KIT GACHE POIGNEE DROIT CT BT	<table border="1"> <thead> <tr> <th>Code</th> <th>Description</th> <th>Qté</th> <th>UOM</th> </tr> </thead> <tbody> <tr> <td>VI0239A1</td> <td>VIS AUTOPERCEU SE 4.2X25 TCB+INOX</td> <td>2.000</td> <td>PCS</td> </tr> <tr> <td>VI1220A1</td> <td>VIS AUTOTARADE UX 4.2x12 TCB MARUTEX PRE</td> <td>2.000</td> <td>PCS</td> </tr> <tr> <td>VM1460A0</td> <td>COUVERCLE LOQUET DROIT PORTE XBC/XVC</td> <td>1.000</td> <td>PCS</td> </tr> <tr> <td>VP1530A0</td> <td>FERMETURE POGNEE DROIT CT BT</td> <td>1.000</td> <td>PCS</td> </tr> </tbody> </table>	Code	Description	Qté	UOM	VI0239A1	VIS AUTOPERCEU SE 4.2X25 TCB+INOX	2.000	PCS	VI1220A1	VIS AUTOTARADE UX 4.2x12 TCB MARUTEX PRE	2.000	PCS	VM1460A0	COUVERCLE LOQUET DROIT PORTE XBC/XVC	1.000	PCS	VP1530A0	FERMETURE POGNEE DROIT CT BT	1.000	PCS											
Code	Description	Qté	UOM																																	
VI0239A1	VIS AUTOPERCEU SE 4.2X25 TCB+INOX	2.000	PCS																																	
VI1220A1	VIS AUTOTARADE UX 4.2x12 TCB MARUTEX PRE	2.000	PCS																																	
VM1460A0	COUVERCLE LOQUET DROIT PORTE XBC/XVC	1.000	PCS																																	
VP1530A0	FERMETURE POGNEE DROIT CT BT	1.000	PCS																																	
VM1192A	CT BT DOOR SPRING LATCH BACK COVER		<p>KVM1191A</p> <p>KIT GACHE POIGNEE GAUCHE CT BT</p> <p>KVM1190A</p> <p>KIT GACHE POIGNEE DROIT CT BT</p>	<table border="1"> <thead> <tr> <th>Code</th> <th>Description</th> <th>Qté</th> <th>UOM</th> </tr> </thead> <tbody> <tr> <td>VI0239A1</td> <td>VIS AUTOPERCEU SE 4.2X25 TCB+INOX</td> <td>2.000</td> <td>PCS</td> </tr> <tr> <td>VI1220A1</td> <td>VIS AUTOTARADE UX 4.2x12 TCB MARUTEX PRE</td> <td>2.000</td> <td>PCS</td> </tr> <tr> <td>VM1460A0</td> <td>COUVERCLE LOQUET DROIT PORTE XBC/XVC</td> <td>1.000</td> <td>PCS</td> </tr> <tr> <td>VP1531A0</td> <td>FERMETURE POGNEE GAUCHE CT B</td> <td>1.000</td> <td>PCS</td> </tr> </tbody> </table> <table border="1"> <thead> <tr> <th>Code</th> <th>Description</th> <th>Qté</th> <th>UOM</th> </tr> </thead> <tbody> <tr> <td>VI0239A1</td> <td>VIS AUTOPERCEU SE 4.2X25 TCB+INOX</td> <td>2.000</td> <td>PCS</td> </tr> <tr> <td>VI1220A1</td> <td>VIS AUTOTARADE UX 4.2x12 TCB MARUTEX PRE</td> <td>2.000</td> <td>PCS</td> </tr> </tbody> </table>	Code	Description	Qté	UOM	VI0239A1	VIS AUTOPERCEU SE 4.2X25 TCB+INOX	2.000	PCS	VI1220A1	VIS AUTOTARADE UX 4.2x12 TCB MARUTEX PRE	2.000	PCS	VM1460A0	COUVERCLE LOQUET DROIT PORTE XBC/XVC	1.000	PCS	VP1531A0	FERMETURE POGNEE GAUCHE CT B	1.000	PCS	Code	Description	Qté	UOM	VI0239A1	VIS AUTOPERCEU SE 4.2X25 TCB+INOX	2.000	PCS	VI1220A1	VIS AUTOTARADE UX 4.2x12 TCB MARUTEX PRE	2.000	PCS
Code	Description	Qté	UOM																																	
VI0239A1	VIS AUTOPERCEU SE 4.2X25 TCB+INOX	2.000	PCS																																	
VI1220A1	VIS AUTOTARADE UX 4.2x12 TCB MARUTEX PRE	2.000	PCS																																	
VM1460A0	COUVERCLE LOQUET DROIT PORTE XBC/XVC	1.000	PCS																																	
VP1531A0	FERMETURE POGNEE GAUCHE CT B	1.000	PCS																																	
Code	Description	Qté	UOM																																	
VI0239A1	VIS AUTOPERCEU SE 4.2X25 TCB+INOX	2.000	PCS																																	
VI1220A1	VIS AUTOTARADE UX 4.2x12 TCB MARUTEX PRE	2.000	PCS																																	

COMPOSANT			PIÈCE DE RECHANGE																						
Code	Description	Image	Code	Description	Composants du kit																				
VM1192A	CT BT DOOR SPRING LATCH BACK COVER		KVM1190A	KIT GACHE POIGNEE DROIT CT BT	<table border="1"> <thead> <tr> <th>Code</th> <th>Description</th> <th>Qté</th> <th>UOM</th> </tr> </thead> <tbody> <tr> <td>VM1460A0</td> <td>COUVERCLE LOQUET DROIT PORTE XBC/XVC</td> <td>1.000</td> <td>PCS</td> </tr> <tr> <td>VP1530A0</td> <td>FERMETURE POGNEE DROIT CT BT</td> <td>1.000</td> <td>PCS</td> </tr> </tbody> </table>	Code	Description	Qté	UOM	VM1460A0	COUVERCLE LOQUET DROIT PORTE XBC/XVC	1.000	PCS	VP1530A0	FERMETURE POGNEE DROIT CT BT	1.000	PCS								
Code	Description	Qté	UOM																						
VM1460A0	COUVERCLE LOQUET DROIT PORTE XBC/XVC	1.000	PCS																						
VP1530A0	FERMETURE POGNEE DROIT CT BT	1.000	PCS																						
VM1630A	BOUCHON POUSSE-VITRE INTERNE		KVM1630A	KIT COUVERCLE PRESSE-VITRE INTERNE 10PCS	<table border="1"> <thead> <tr> <th>Code</th> <th>Description</th> <th>Qté</th> <th>UOM</th> </tr> </thead> <tbody> <tr> <td>VM1630A1</td> <td>BOUCHON POUSSE-VITR E INTERNE</td> <td>10.000</td> <td>PCS</td> </tr> </tbody> </table>	Code	Description	Qté	UOM	VM1630A1	BOUCHON POUSSE-VITR E INTERNE	10.000	PCS												
Code	Description	Qté	UOM																						
VM1630A1	BOUCHON POUSSE-VITR E INTERNE	10.000	PCS																						
VM2280A	PLAQUE COUVERTURE GACHE		KVM2280A	KIT PLAQUETTE COUVRE-TROUS GACHE	<table border="1"> <thead> <tr> <th>Code</th> <th>Description</th> <th>Qté</th> <th>UOM</th> </tr> </thead> <tbody> <tr> <td>VI1074A0</td> <td>VIS POUR PLASTIQUE 4X16 TCB+INO</td> <td>2.000</td> <td>PCS</td> </tr> <tr> <td>VM1630A1</td> <td>BOUCHON POUSSE-VITR E INTERNE</td> <td>2.000</td> <td>PCS</td> </tr> <tr> <td>VM2280A1</td> <td>PLAQUE COUVERTURE GACHE</td> <td>1.000</td> <td>PCS</td> </tr> </tbody> </table>	Code	Description	Qté	UOM	VI1074A0	VIS POUR PLASTIQUE 4X16 TCB+INO	2.000	PCS	VM1630A1	BOUCHON POUSSE-VITR E INTERNE	2.000	PCS	VM2280A1	PLAQUE COUVERTURE GACHE	1.000	PCS				
Code	Description	Qté	UOM																						
VI1074A0	VIS POUR PLASTIQUE 4X16 TCB+INO	2.000	PCS																						
VM1630A1	BOUCHON POUSSE-VITR E INTERNE	2.000	PCS																						
VM2280A1	PLAQUE COUVERTURE GACHE	1.000	PCS																						
VM1191A	CT BT LEFT DOOR SPRING LATCH		KVM1191A	KIT GACHE POIGNEE GAUCHE CT BT	<table border="1"> <thead> <tr> <th>Code</th> <th>Description</th> <th>Qté</th> <th>UOM</th> </tr> </thead> <tbody> <tr> <td>VI0239A1</td> <td>VIS AUTOPERCEU SE 4.2X25 TCB+INOX</td> <td>2.000</td> <td>PCS</td> </tr> <tr> <td>VI1220A1</td> <td>VIS AUTOTARADE UX 4.2x12 TCB MARUTEX PRE</td> <td>2.000</td> <td>PCS</td> </tr> <tr> <td>VM1460A0</td> <td>COUVERCLE LOQUET DROIT PORTE XBC/XVC</td> <td>1.000</td> <td>PCS</td> </tr> <tr> <td>VP1531A0</td> <td>FERMETURE POGNEE GAUCHE CT B</td> <td>1.000</td> <td>PCS</td> </tr> </tbody> </table>	Code	Description	Qté	UOM	VI0239A1	VIS AUTOPERCEU SE 4.2X25 TCB+INOX	2.000	PCS	VI1220A1	VIS AUTOTARADE UX 4.2x12 TCB MARUTEX PRE	2.000	PCS	VM1460A0	COUVERCLE LOQUET DROIT PORTE XBC/XVC	1.000	PCS	VP1531A0	FERMETURE POGNEE GAUCHE CT B	1.000	PCS
Code	Description	Qté	UOM																						
VI0239A1	VIS AUTOPERCEU SE 4.2X25 TCB+INOX	2.000	PCS																						
VI1220A1	VIS AUTOTARADE UX 4.2x12 TCB MARUTEX PRE	2.000	PCS																						
VM1460A0	COUVERCLE LOQUET DROIT PORTE XBC/XVC	1.000	PCS																						
VP1531A0	FERMETURE POGNEE GAUCHE CT B	1.000	PCS																						

COMPOSANT			PIÈCE DE RECHANGE																						
Code	Description	Image	Code	Description	Composants du kit																				
VM1192A	CT BT DOOR SPRING LATCH BACK COVER		KVM1191A	KIT GACHE POIGNEE GAUCHE CT BT	<table border="1"> <thead> <tr> <th>Code</th> <th>Description</th> <th>Qté</th> <th>UOM</th> </tr> </thead> <tbody> <tr> <td>VI0239A1</td> <td>VIS AUTOPERCEU SE 4.2X25 TCB+INOX</td> <td>2.000</td> <td>PCS</td> </tr> <tr> <td>VI1220A1</td> <td>VIS AUTOTARADE UX 4.2x12 TCB MARUTEX PRE</td> <td>2.000</td> <td>PCS</td> </tr> <tr> <td>VM1460A0</td> <td>COUVERCLE LOQUET DROIT PORTE XBC/XVC</td> <td>1.000</td> <td>PCS</td> </tr> <tr> <td>VP1531A0</td> <td>FERMETURE POGNEE GAUCHE CT B</td> <td>1.000</td> <td>PCS</td> </tr> </tbody> </table>	Code	Description	Qté	UOM	VI0239A1	VIS AUTOPERCEU SE 4.2X25 TCB+INOX	2.000	PCS	VI1220A1	VIS AUTOTARADE UX 4.2x12 TCB MARUTEX PRE	2.000	PCS	VM1460A0	COUVERCLE LOQUET DROIT PORTE XBC/XVC	1.000	PCS	VP1531A0	FERMETURE POGNEE GAUCHE CT B	1.000	PCS
			Code	Description	Qté	UOM																			
VI0239A1	VIS AUTOPERCEU SE 4.2X25 TCB+INOX	2.000	PCS																						
VI1220A1	VIS AUTOTARADE UX 4.2x12 TCB MARUTEX PRE	2.000	PCS																						
VM1460A0	COUVERCLE LOQUET DROIT PORTE XBC/XVC	1.000	PCS																						
VP1531A0	FERMETURE POGNEE GAUCHE CT B	1.000	PCS																						
KVM1190A	KIT GACHE POIGNEE DROIT CT BT	<table border="1"> <thead> <tr> <th>Code</th> <th>Description</th> <th>Qté</th> <th>UOM</th> </tr> </thead> <tbody> <tr> <td>VI0239A1</td> <td>VIS AUTOPERCEU SE 4.2X25 TCB+INOX</td> <td>2.000</td> <td>PCS</td> </tr> <tr> <td>VI1220A1</td> <td>VIS AUTOTARADE UX 4.2x12 TCB MARUTEX PRE</td> <td>2.000</td> <td>PCS</td> </tr> <tr> <td>VM1460A0</td> <td>COUVERCLE LOQUET DROIT PORTE XBC/XVC</td> <td>1.000</td> <td>PCS</td> </tr> <tr> <td>VP1530A0</td> <td>FERMETURE POGNEE DROIT CT BT</td> <td>1.000</td> <td>PCS</td> </tr> </tbody> </table>	Code	Description	Qté	UOM	VI0239A1	VIS AUTOPERCEU SE 4.2X25 TCB+INOX	2.000	PCS	VI1220A1	VIS AUTOTARADE UX 4.2x12 TCB MARUTEX PRE	2.000	PCS	VM1460A0	COUVERCLE LOQUET DROIT PORTE XBC/XVC	1.000	PCS	VP1530A0	FERMETURE POGNEE DROIT CT BT	1.000	PCS			
Code	Description	Qté	UOM																						
VI0239A1	VIS AUTOPERCEU SE 4.2X25 TCB+INOX	2.000	PCS																						
VI1220A1	VIS AUTOTARADE UX 4.2x12 TCB MARUTEX PRE	2.000	PCS																						
VM1460A0	COUVERCLE LOQUET DROIT PORTE XBC/XVC	1.000	PCS																						
VP1530A0	FERMETURE POGNEE DROIT CT BT	1.000	PCS																						
VM2281A	PLAQUETTE COUVRE TROUS		KVM2281A	KIT PLAQUETTE COUVRE -TROUS VM2281A0	<table border="1"> <thead> <tr> <th>Code</th> <th>Description</th> <th>Qté</th> <th>UOM</th> </tr> </thead> <tbody> <tr> <td>VM2281A0</td> <td>PLAQUETTE COUVRE TROUS</td> <td>1.000</td> <td>PCS</td> </tr> </tbody> </table>	Code	Description	Qté	UOM	VM2281A0	PLAQUETTE COUVRE TROUS	1.000	PCS												
Code	Description	Qté	UOM																						
VM2281A0	PLAQUETTE COUVRE TROUS	1.000	PCS																						
SB1015A	4L DETERGENT TAN		KSB1015A	KIT RESERVOIR DETERGENT 4L	<table border="1"> <thead> <tr> <th>Code</th> <th>Description</th> <th>Qté</th> <th>UOM</th> </tr> </thead> <tbody> <tr> <td>SB1015A3</td> <td>BAC A PRODUIT 4L + PERCE-OPER CULE</td> <td>1.000</td> <td>PCS</td> </tr> </tbody> </table>	Code	Description	Qté	UOM	SB1015A3	BAC A PRODUIT 4L + PERCE-OPER CULE	1.000	PCS												
Code	Description	Qté	UOM																						
SB1015A3	BAC A PRODUIT 4L + PERCE-OPER CULE	1.000	PCS																						

COMPOSANT			PIÈCE DE RECHANGE																										
Code	Description	Image	Code	Description	Composants du kit																								
VM1118A	DET&Rinse PLUS TANK LEFT GUIDE		KVM1118A	KIT GUIDE GAUCHE RESERVOIR DET.M	<table border="1"> <thead> <tr> <th>Code</th> <th>Description</th> <th>Qté</th> <th>UOM</th> </tr> </thead> <tbody> <tr> <td>VI1220A1</td> <td>VIS AUTOTARADE UX 4.2x12 TCB MARUTEX PRE</td> <td>2.000</td> <td>PCS</td> </tr> <tr> <td>VM1118A0</td> <td>DET&Rinse PLUS TANK LEFT GUIDE</td> <td>1.000</td> <td>PCS</td> </tr> </tbody> </table>	Code	Description	Qté	UOM	VI1220A1	VIS AUTOTARADE UX 4.2x12 TCB MARUTEX PRE	2.000	PCS	VM1118A0	DET&Rinse PLUS TANK LEFT GUIDE	1.000	PCS												
					Code	Description	Qté	UOM																					
VI1220A1	VIS AUTOTARADE UX 4.2x12 TCB MARUTEX PRE	2.000	PCS																										
VM1118A0	DET&Rinse PLUS TANK LEFT GUIDE	1.000	PCS																										
<table border="1"> <thead> <tr> <th>Code</th> <th>Description</th> <th>Qté</th> <th>UOM</th> </tr> </thead> <tbody> <tr> <td>VI1220A1</td> <td>VIS AUTOTARADE UX 4.2x12 TCB MARUTEX PRE</td> <td>2.000</td> <td>PCS</td> </tr> <tr> <td>VM1119A0</td> <td>GUIDE DROITE RESERVOIR DET&RINSE PLUS</td> <td>1.000</td> <td>PCS</td> </tr> </tbody> </table>	Code	Description	Qté	UOM	VI1220A1	VIS AUTOTARADE UX 4.2x12 TCB MARUTEX PRE	2.000	PCS	VM1119A0	GUIDE DROITE RESERVOIR DET&RINSE PLUS	1.000	PCS																	
Code	Description	Qté	UOM																										
VI1220A1	VIS AUTOTARADE UX 4.2x12 TCB MARUTEX PRE	2.000	PCS																										
VM1119A0	GUIDE DROITE RESERVOIR DET&RINSE PLUS	1.000	PCS																										
VM1119A	GUIDE DROITE RESERVOIR DET&RINSE PLUS		KVM1119A	KIT GUIDE DROITE RESERVOIR DET.M	<table border="1"> <thead> <tr> <th>Code</th> <th>Description</th> <th>Qté</th> <th>UOM</th> </tr> </thead> <tbody> <tr> <td>VI1220A1</td> <td>VIS AUTOTARADE UX 4.2x12 TCB MARUTEX PRE</td> <td>2.000</td> <td>PCS</td> </tr> <tr> <td>VM1119A0</td> <td>GUIDE DROITE RESERVOIR DET&RINSE PLUS</td> <td>1.000</td> <td>PCS</td> </tr> </tbody> </table>	Code	Description	Qté	UOM	VI1220A1	VIS AUTOTARADE UX 4.2x12 TCB MARUTEX PRE	2.000	PCS	VM1119A0	GUIDE DROITE RESERVOIR DET&RINSE PLUS	1.000	PCS												
					Code	Description	Qté	UOM																					
VI1220A1	VIS AUTOTARADE UX 4.2x12 TCB MARUTEX PRE	2.000	PCS																										
VM1119A0	GUIDE DROITE RESERVOIR DET&RINSE PLUS	1.000	PCS																										
<table border="1"> <thead> <tr> <th>Code</th> <th>Description</th> <th>Qté</th> <th>UOM</th> </tr> </thead> <tbody> <tr> <td>VI1220A1</td> <td>VIS AUTOTARADE UX 4.2x12 TCB MARUTEX PRE</td> <td>4.000</td> <td>PCS</td> </tr> <tr> <td>VL1014B3</td> <td></td> <td>1.000</td> <td>PCS</td> </tr> <tr> <td>VL1034C0</td> <td>MESH WATER FILTER D10</td> <td>1.000</td> <td>PCS</td> </tr> <tr> <td>VL1062C0</td> <td>PRESSURE REDUCER-FIL TER LOCKING FORK</td> <td>1.000</td> <td>PCS</td> </tr> <tr> <td>VM1054A0</td> <td>BAGUE REDUCTEUR DE PRESSION H7.8</td> <td>1.000</td> <td>PCS</td> </tr> </tbody> </table>	Code	Description	Qté	UOM	VI1220A1	VIS AUTOTARADE UX 4.2x12 TCB MARUTEX PRE	4.000	PCS	VL1014B3		1.000	PCS	VL1034C0	MESH WATER FILTER D10	1.000	PCS	VL1062C0	PRESSURE REDUCER-FIL TER LOCKING FORK	1.000	PCS	VM1054A0	BAGUE REDUCTEUR DE PRESSION H7.8	1.000	PCS					
Code	Description	Qté	UOM																										
VI1220A1	VIS AUTOTARADE UX 4.2x12 TCB MARUTEX PRE	4.000	PCS																										
VL1014B3		1.000	PCS																										
VL1034C0	MESH WATER FILTER D10	1.000	PCS																										
VL1062C0	PRESSURE REDUCER-FIL TER LOCKING FORK	1.000	PCS																										
VM1054A0	BAGUE REDUCTEUR DE PRESSION H7.8	1.000	PCS																										
0H7472A	DISTRIBUTOR SUPPORT PLATE		KVL1117A	KIT FILTRE RED. PRESS. EUR MM 2016+LMTop	<table border="1"> <thead> <tr> <th>Code</th> <th>Description</th> <th>Qté</th> <th>UOM</th> </tr> </thead> <tbody> <tr> <td>0H7472A1</td> <td>DISTRIBUTOR SUPPORT PLATE</td> <td>1.000</td> <td>PCS</td> </tr> <tr> <td>RC1004A0</td> <td>Ø10-Ø8-8 Y CONNECTION</td> <td>1.000</td> <td>PCS</td> </tr> <tr> <td>RC1243A0</td> <td>Ø10F-Ø10M ELBOW CONNECTION + JG END KIT</td> <td>1.000</td> <td>PCS</td> </tr> <tr> <td>RC1372A0</td> <td>RACCORD DROIT Ø10M-1/4 M CI</td> <td>2.000</td> <td>PCS</td> </tr> <tr> <td>VI1220A1</td> <td>VIS AUTOTARADE UX 4.2x12 TCB MARUTEX PRE</td> <td>4.000</td> <td>PCS</td> </tr> </tbody> </table>	Code	Description	Qté	UOM	0H7472A1	DISTRIBUTOR SUPPORT PLATE	1.000	PCS	RC1004A0	Ø10-Ø8-8 Y CONNECTION	1.000	PCS	RC1243A0	Ø10F-Ø10M ELBOW CONNECTION + JG END KIT	1.000	PCS	RC1372A0	RACCORD DROIT Ø10M-1/4 M CI	2.000	PCS	VI1220A1	VIS AUTOTARADE UX 4.2x12 TCB MARUTEX PRE	4.000	PCS
					Code	Description	Qté	UOM																					
0H7472A1	DISTRIBUTOR SUPPORT PLATE	1.000	PCS																										
RC1004A0	Ø10-Ø8-8 Y CONNECTION	1.000	PCS																										
RC1243A0	Ø10F-Ø10M ELBOW CONNECTION + JG END KIT	1.000	PCS																										
RC1372A0	RACCORD DROIT Ø10M-1/4 M CI	2.000	PCS																										
VI1220A1	VIS AUTOTARADE UX 4.2x12 TCB MARUTEX PRE	4.000	PCS																										
<table border="1"> <thead> <tr> <th>Code</th> <th>Description</th> <th>Qté</th> <th>UOM</th> </tr> </thead> <tbody> <tr> <td>0H7472A1</td> <td>DISTRIBUTOR SUPPORT PLATE</td> <td>1.000</td> <td>PCS</td> </tr> </tbody> </table>	Code	Description	Qté	UOM	0H7472A1	DISTRIBUTOR SUPPORT PLATE	1.000	PCS																					
Code	Description	Qté	UOM																										
0H7472A1	DISTRIBUTOR SUPPORT PLATE	1.000	PCS																										
			K0H7472A	KIT SUPPORT DISTRIBUTEUR																									

COMPOSANT			PIÈCE DE RECHANGE																																																													
Code	Description	Image	Code	Description	Composants du kit																																																											
RC1372A	RACCORD DROIT Ø10M-1/4 M CIL		KVL1163A	KIT RACCORD HYDRIQUE MM	<table border="1"> <thead> <tr> <th>Code</th> <th>Description</th> <th>Qté</th> <th>UOM</th> </tr> </thead> <tbody> <tr> <td>0H8038A0</td> <td>TOLE SUPPORT REDUCTEUR MM</td> <td>1.000</td> <td>PCS</td> </tr> <tr> <td>0H8039A0</td> <td>TOLE SUPPORT REDUCTEUR COMPACT MM</td> <td>1.000</td> <td>PCS</td> </tr> <tr> <td>CH1026A0</td> <td>CLÉ JOHN GUEST UNOX Ø8-Ø10</td> <td>1.000</td> <td>PCS</td> </tr> <tr> <td>RC1243A0</td> <td>Ø10F-Ø10M ELBOW CONNECTION + JG END KIT</td> <td>2.000</td> <td>PCS</td> </tr> <tr> <td>RC1396A0</td> <td>EXTREMITE DROITE JG D10-1/4</td> <td>2.000</td> <td>PCS</td> </tr> <tr> <td>TB2243A0</td> <td>TUYAU DIAMETRE 10 TRANSPAREN</td> <td>1.500</td> <td>M</td> </tr> <tr> <td>VI1220A1</td> <td>VIS AUTOTARADE UX 4.2x12 TCB MARUTEX PRE</td> <td>2.000</td> <td>PCS</td> </tr> <tr> <td>VI1950A0</td> <td>VIS AUTOPERCEU SE 4.2X13 TCB INOX</td> <td>1.000</td> <td>PCS</td> </tr> <tr> <td>VL1014B3</td> <td></td> <td>1.000</td> <td>PCS</td> </tr> <tr> <td>VL1135A1</td> <td>3/4-JG10 CONNECTOR + FILTER AND NRV</td> <td>1.000</td> <td>PCS</td> </tr> <tr> <td>VM1054A0</td> <td>BAGUE REDUCTEUR DE PRESSION H7.8</td> <td>1.000</td> <td>PCS</td> </tr> </tbody> </table>	Code	Description	Qté	UOM	0H8038A0	TOLE SUPPORT REDUCTEUR MM	1.000	PCS	0H8039A0	TOLE SUPPORT REDUCTEUR COMPACT MM	1.000	PCS	CH1026A0	CLÉ JOHN GUEST UNOX Ø8-Ø10	1.000	PCS	RC1243A0	Ø10F-Ø10M ELBOW CONNECTION + JG END KIT	2.000	PCS	RC1396A0	EXTREMITE DROITE JG D10-1/4	2.000	PCS	TB2243A0	TUYAU DIAMETRE 10 TRANSPAREN	1.500	M	VI1220A1	VIS AUTOTARADE UX 4.2x12 TCB MARUTEX PRE	2.000	PCS	VI1950A0	VIS AUTOPERCEU SE 4.2X13 TCB INOX	1.000	PCS	VL1014B3		1.000	PCS	VL1135A1	3/4-JG10 CONNECTOR + FILTER AND NRV	1.000	PCS	VM1054A0	BAGUE REDUCTEUR DE PRESSION H7.8	1.000	PCS	KRC1372A	KIT RACCORD DROIT D 10M-1/4 M CIL	<table border="1"> <thead> <tr> <th>Code</th> <th>Description</th> <th>Qté</th> <th>UOM</th> </tr> </thead> <tbody> <tr> <td>RC1372A0</td> <td>RACCORD DROIT Ø10M-1/4 M CI</td> <td>1.000</td> <td>PCS</td> </tr> </tbody> </table>	Code	Description	Qté	UOM	RC1372A0	RACCORD DROIT Ø10M-1/4 M CI	1.000	PCS
			Code	Description	Qté	UOM																																																										
0H8038A0	TOLE SUPPORT REDUCTEUR MM	1.000	PCS																																																													
0H8039A0	TOLE SUPPORT REDUCTEUR COMPACT MM	1.000	PCS																																																													
CH1026A0	CLÉ JOHN GUEST UNOX Ø8-Ø10	1.000	PCS																																																													
RC1243A0	Ø10F-Ø10M ELBOW CONNECTION + JG END KIT	2.000	PCS																																																													
RC1396A0	EXTREMITE DROITE JG D10-1/4	2.000	PCS																																																													
TB2243A0	TUYAU DIAMETRE 10 TRANSPAREN	1.500	M																																																													
VI1220A1	VIS AUTOTARADE UX 4.2x12 TCB MARUTEX PRE	2.000	PCS																																																													
VI1950A0	VIS AUTOPERCEU SE 4.2X13 TCB INOX	1.000	PCS																																																													
VL1014B3		1.000	PCS																																																													
VL1135A1	3/4-JG10 CONNECTOR + FILTER AND NRV	1.000	PCS																																																													
VM1054A0	BAGUE REDUCTEUR DE PRESSION H7.8	1.000	PCS																																																													
Code	Description	Qté	UOM																																																													
RC1372A0	RACCORD DROIT Ø10M-1/4 M CI	1.000	PCS																																																													
RC1396A	EXTREMITE DROITE JG D10-1/4		KVL0014B	KIT REDUCTEUR DE PRESSION MM ≥201	<table border="1"> <thead> <tr> <th>Code</th> <th>Description</th> <th>Qté</th> <th>UOM</th> </tr> </thead> <tbody> <tr> <td>RC1372A0</td> <td>RACCORD DROIT Ø10M-1/4 M CI</td> <td>1.000</td> <td>PCS</td> </tr> <tr> <td>RC1396A0</td> <td>EXTREMITE DROITE JG D10-1/4</td> <td>1.000</td> <td>PCS</td> </tr> <tr> <td>VL1014B3</td> <td></td> <td>1.000</td> <td>PCS</td> </tr> <tr> <td>VM1054A0</td> <td>BAGUE REDUCTEUR DE PRESSION H7.8</td> <td>1.000</td> <td>PCS</td> </tr> </tbody> </table>	Code	Description	Qté	UOM	RC1372A0	RACCORD DROIT Ø10M-1/4 M CI	1.000	PCS	RC1396A0	EXTREMITE DROITE JG D10-1/4	1.000	PCS	VL1014B3		1.000	PCS	VM1054A0	BAGUE REDUCTEUR DE PRESSION H7.8	1.000	PCS																																							
Code	Description	Qté	UOM																																																													
RC1372A0	RACCORD DROIT Ø10M-1/4 M CI	1.000	PCS																																																													
RC1396A0	EXTREMITE DROITE JG D10-1/4	1.000	PCS																																																													
VL1014B3		1.000	PCS																																																													
VM1054A0	BAGUE REDUCTEUR DE PRESSION H7.8	1.000	PCS																																																													





COMPOSANT			PIÈCE DE RECHANGE																										
Code	Description	Image	Code	Description	Composants du kit																								
VL1014B	REDUCTEUR DE PRESSION AVEC DISTRIBUTEUR		KVL0020A	KIT RED PRESS 03-05XX≥OCT18/MM -LUX≥MAR19	<table border="1"> <thead> <tr> <th>Code</th> <th>Description</th> <th>Qté</th> <th>UOM</th> </tr> </thead> <tbody> <tr> <td>RC1396A0</td> <td>EXTREMITE DROITE JG D10-1/4</td> <td>2.000</td> <td>PCS</td> </tr> <tr> <td>VL1014B3</td> <td></td> <td>1.000</td> <td>PCS</td> </tr> <tr> <td>VM1054A0</td> <td>BAGUE REDUCTEUR DE PRESSION H7.8</td> <td>1.000</td> <td>PCS</td> </tr> </tbody> </table>	Code	Description	Qté	UOM	RC1396A0	EXTREMITE DROITE JG D10-1/4	2.000	PCS	VL1014B3		1.000	PCS	VM1054A0	BAGUE REDUCTEUR DE PRESSION H7.8	1.000	PCS								
			Code	Description	Qté	UOM																							
			RC1396A0	EXTREMITE DROITE JG D10-1/4	2.000	PCS																							
			VL1014B3		1.000	PCS																							
VM1054A0	BAGUE REDUCTEUR DE PRESSION H7.8	1.000	PCS																										
KVL0014B	KIT REDUCTEUR DE PRESSION MM ≥201	<table border="1"> <thead> <tr> <th>Code</th> <th>Description</th> <th>Qté</th> <th>UOM</th> </tr> </thead> <tbody> <tr> <td>RC1372A0</td> <td>RACCORD DROIT Ø10M-1/4 M CI</td> <td>1.000</td> <td>PCS</td> </tr> <tr> <td>RC1396A0</td> <td>EXTREMITE DROITE JG D10-1/4</td> <td>1.000</td> <td>PCS</td> </tr> <tr> <td>VL1014B3</td> <td></td> <td>1.000</td> <td>PCS</td> </tr> <tr> <td>VM1054A0</td> <td>BAGUE REDUCTEUR DE PRESSION H7.8</td> <td>1.000</td> <td>PCS</td> </tr> </tbody> </table>	Code	Description	Qté	UOM	RC1372A0	RACCORD DROIT Ø10M-1/4 M CI	1.000	PCS	RC1396A0	EXTREMITE DROITE JG D10-1/4	1.000	PCS	VL1014B3		1.000	PCS	VM1054A0	BAGUE REDUCTEUR DE PRESSION H7.8	1.000	PCS							
Code	Description	Qté	UOM																										
RC1372A0	RACCORD DROIT Ø10M-1/4 M CI	1.000	PCS																										
RC1396A0	EXTREMITE DROITE JG D10-1/4	1.000	PCS																										
VL1014B3		1.000	PCS																										
VM1054A0	BAGUE REDUCTEUR DE PRESSION H7.8	1.000	PCS																										
KVL0014A	KIT REDUCTEUR DE PRESSION MM ≤2016 / LUX	<table border="1"> <thead> <tr> <th>Code</th> <th>Description</th> <th>Qté</th> <th>UOM</th> </tr> </thead> <tbody> <tr> <td>RC1372A0</td> <td>RACCORD DROIT Ø10M-1/4 M CI</td> <td>2.000</td> <td>PCS</td> </tr> <tr> <td>VL1014B3</td> <td></td> <td>1.000</td> <td>PCS</td> </tr> <tr> <td>VM1054A0</td> <td>BAGUE REDUCTEUR DE PRESSION H7.8</td> <td>1.000</td> <td>PCS</td> </tr> </tbody> </table>	Code	Description	Qté	UOM	RC1372A0	RACCORD DROIT Ø10M-1/4 M CI	2.000	PCS	VL1014B3		1.000	PCS	VM1054A0	BAGUE REDUCTEUR DE PRESSION H7.8	1.000	PCS											
Code	Description	Qté	UOM																										
RC1372A0	RACCORD DROIT Ø10M-1/4 M CI	2.000	PCS																										
VL1014B3		1.000	PCS																										
VM1054A0	BAGUE REDUCTEUR DE PRESSION H7.8	1.000	PCS																										
KVL0010A	KIT REDUCTEUR DE PRESSION SERIE 4 ET 5	<table border="1"> <thead> <tr> <th>Code</th> <th>Description</th> <th>Qté</th> <th>UOM</th> </tr> </thead> <tbody> <tr> <td>EL1210A0</td> <td>D8-BSP1/4 JG STRAIGHT END CONNECTION</td> <td>2.000</td> <td>PCS</td> </tr> <tr> <td>VL1014B3</td> <td></td> <td>1.000</td> <td>PCS</td> </tr> </tbody> </table>	Code	Description	Qté	UOM	EL1210A0	D8-BSP1/4 JG STRAIGHT END CONNECTION	2.000	PCS	VL1014B3		1.000	PCS															
Code	Description	Qté	UOM																										
EL1210A0	D8-BSP1/4 JG STRAIGHT END CONNECTION	2.000	PCS																										
VL1014B3		1.000	PCS																										
RC1243A	Ø10F-Ø10M ELBOW CONNECTION + JG END KIT		KVL1413A	KIT LAVAGE HOTTE SPX EU	<table border="1"> <thead> <tr> <th>Code</th> <th>Description</th> <th>Qté</th> <th>UOM</th> </tr> </thead> <tbody> <tr> <td>0H2514A1</td> <td>TOLE SOUTIEN EL1440</td> <td>1.000</td> <td>PCS</td> </tr> <tr> <td>0H5472A0</td> <td></td> <td>1.000</td> <td>PCS</td> </tr> <tr> <td>EL1440A0</td> <td>ELECTROVAN NE H20 AUTONETTOY ANTE BAIONNET</td> <td>1.000</td> <td>PCS</td> </tr> <tr> <td>GN1526A0</td> <td>O-RING D.INT6,9 SP1.8</td> <td>2.000</td> <td>PCS</td> </tr> <tr> <td>RC1018A0</td> <td>COLLIER ELASTIQUE D12 ZINGUE</td> <td>4.000</td> <td>PCS</td> </tr> </tbody> </table>	Code	Description	Qté	UOM	0H2514A1	TOLE SOUTIEN EL1440	1.000	PCS	0H5472A0		1.000	PCS	EL1440A0	ELECTROVAN NE H20 AUTONETTOY ANTE BAIONNET	1.000	PCS	GN1526A0	O-RING D.INT6,9 SP1.8	2.000	PCS	RC1018A0	COLLIER ELASTIQUE D12 ZINGUE	4.000	PCS
Code	Description	Qté	UOM																										
0H2514A1	TOLE SOUTIEN EL1440	1.000	PCS																										
0H5472A0		1.000	PCS																										
EL1440A0	ELECTROVAN NE H20 AUTONETTOY ANTE BAIONNET	1.000	PCS																										
GN1526A0	O-RING D.INT6,9 SP1.8	2.000	PCS																										
RC1018A0	COLLIER ELASTIQUE D12 ZINGUE	4.000	PCS																										



COMPOSANT			PIÈCE DE RECHANGE																																																																																																				
Code	Description	Image	Code	Description	Composants du kit																																																																																																		
RC1243A	Ø10F-Ø10M ELBOW CONNECTION + JG END KIT		KVL1413A	KIT LAVAGE HOTTE SPX EU	<table border="1"> <thead> <tr> <th>Code</th> <th>Description</th> <th>Qté</th> <th>UOM</th> </tr> </thead> <tbody> <tr> <td>RC1243A0</td> <td>Ø10F-Ø10M ELBOW CONNECTION + JG END KIT</td> <td>1.000</td> <td>PCS</td> </tr> <tr> <td>RC1396A0</td> <td>EXTREMITE DROITE JG D10-1/4</td> <td>2.000</td> <td>PCS</td> </tr> <tr> <td>TB3252A0</td> <td>TB3252A0</td> <td>1.000</td> <td>PCS</td> </tr> <tr> <td>TB3426A0</td> <td></td> <td>1.000</td> <td>PCS</td> </tr> <tr> <td>VI1220A1</td> <td>VIS AUTOTARADE UX 4.2x12 TCB MARUTEX PRE</td> <td>2.000</td> <td>PCS</td> </tr> <tr> <td>VL1014B3</td> <td></td> <td>1.000</td> <td>PCS</td> </tr> <tr> <td>VL1095A0</td> <td>RACC DROIT M-M RACC CANNELE D7.8-D10</td> <td>1.000</td> <td>PCS</td> </tr> <tr> <td>VL1165A0</td> <td>RACCORD DROIT BAM-BB6</td> <td>2.000</td> <td>PCS</td> </tr> <tr> <td>VM1054A0</td> <td>BAGUE REDUCTEUR DE PRESSION H7.8</td> <td>1.000</td> <td>PCS</td> </tr> <tr> <td>VM1605A0</td> <td>CLIP TWIST LOCK DIAM. 10.2-12.7 MM</td> <td>1.000</td> <td>PCS</td> </tr> <tr> <td>VM2652A0</td> <td>SELLE DE FIL</td> <td>1.000</td> <td>PCS</td> </tr> </tbody> </table>	Code	Description	Qté	UOM	RC1243A0	Ø10F-Ø10M ELBOW CONNECTION + JG END KIT	1.000	PCS	RC1396A0	EXTREMITE DROITE JG D10-1/4	2.000	PCS	TB3252A0	TB3252A0	1.000	PCS	TB3426A0		1.000	PCS	VI1220A1	VIS AUTOTARADE UX 4.2x12 TCB MARUTEX PRE	2.000	PCS	VL1014B3		1.000	PCS	VL1095A0	RACC DROIT M-M RACC CANNELE D7.8-D10	1.000	PCS	VL1165A0	RACCORD DROIT BAM-BB6	2.000	PCS	VM1054A0	BAGUE REDUCTEUR DE PRESSION H7.8	1.000	PCS	VM1605A0	CLIP TWIST LOCK DIAM. 10.2-12.7 MM	1.000	PCS	VM2652A0	SELLE DE FIL	1.000	PCS	KVL1407A	KIT REDUCTEUR DE PRESSION 1.3 BAR CBX	<table border="1"> <thead> <tr> <th>Code</th> <th>Description</th> <th>Qté</th> <th>UOM</th> </tr> </thead> <tbody> <tr> <td>RC1243A0</td> <td>Ø10F-Ø10M ELBOW CONNECTION + JG END KIT</td> <td>1.000</td> <td>PCS</td> </tr> <tr> <td>RC1396A0</td> <td>EXTREMITE DROITE JG D10-1/4</td> <td>2.000</td> <td>PCS</td> </tr> <tr> <td>VL1279A1</td> <td>REDUCTEUR DE PRESSION</td> <td>1.000</td> <td>PCS</td> </tr> </tbody> </table>	Code	Description	Qté	UOM	RC1243A0	Ø10F-Ø10M ELBOW CONNECTION + JG END KIT	1.000	PCS	RC1396A0	EXTREMITE DROITE JG D10-1/4	2.000	PCS	VL1279A1	REDUCTEUR DE PRESSION	1.000	PCS	KVL1315A	KIT RESERV RECIRC (SANS POMPE) CBX	<table border="1"> <thead> <tr> <th>Code</th> <th>Description</th> <th>Qté</th> <th>UOM</th> </tr> </thead> <tbody> <tr> <td>OH6686A0</td> <td></td> <td>1.000</td> <td>PCS</td> </tr> <tr> <td>GN1400A0</td> <td>U-TRAP SEAL</td> <td>1.000</td> <td>PCS</td> </tr> <tr> <td>RC1019A0</td> <td>COLLIER ELASTIQUE D10 ZINGUE</td> <td>2.000</td> <td>PCS</td> </tr> <tr> <td>RC1243A0</td> <td>Ø10F-Ø10M ELBOW CONNECTION + JG END KIT</td> <td>1.000</td> <td>PCS</td> </tr> <tr> <td>RC1360A0</td> <td>10 - 10 JG ELBOW FITTIN</td> <td>2.000</td> <td>PCS</td> </tr> <tr> <td>RC1378A0</td> <td>PINCE DURITE</td> <td>1.000</td> <td>PCS</td> </tr> </tbody> </table>	Code	Description	Qté	UOM	OH6686A0		1.000	PCS	GN1400A0	U-TRAP SEAL	1.000	PCS	RC1019A0	COLLIER ELASTIQUE D10 ZINGUE	2.000	PCS	RC1243A0	Ø10F-Ø10M ELBOW CONNECTION + JG END KIT	1.000	PCS	RC1360A0	10 - 10 JG ELBOW FITTIN	2.000	PCS	RC1378A0	PINCE DURITE	1.000	PCS
			Code	Description	Qté	UOM																																																																																																	
			RC1243A0	Ø10F-Ø10M ELBOW CONNECTION + JG END KIT	1.000	PCS																																																																																																	
RC1396A0	EXTREMITE DROITE JG D10-1/4	2.000	PCS																																																																																																				
TB3252A0	TB3252A0	1.000	PCS																																																																																																				
TB3426A0		1.000	PCS																																																																																																				
VI1220A1	VIS AUTOTARADE UX 4.2x12 TCB MARUTEX PRE	2.000	PCS																																																																																																				
VL1014B3		1.000	PCS																																																																																																				
VL1095A0	RACC DROIT M-M RACC CANNELE D7.8-D10	1.000	PCS																																																																																																				
VL1165A0	RACCORD DROIT BAM-BB6	2.000	PCS																																																																																																				
VM1054A0	BAGUE REDUCTEUR DE PRESSION H7.8	1.000	PCS																																																																																																				
VM1605A0	CLIP TWIST LOCK DIAM. 10.2-12.7 MM	1.000	PCS																																																																																																				
VM2652A0	SELLE DE FIL	1.000	PCS																																																																																																				
Code	Description	Qté	UOM																																																																																																				
RC1243A0	Ø10F-Ø10M ELBOW CONNECTION + JG END KIT	1.000	PCS																																																																																																				
RC1396A0	EXTREMITE DROITE JG D10-1/4	2.000	PCS																																																																																																				
VL1279A1	REDUCTEUR DE PRESSION	1.000	PCS																																																																																																				
Code	Description	Qté	UOM																																																																																																				
OH6686A0		1.000	PCS																																																																																																				
GN1400A0	U-TRAP SEAL	1.000	PCS																																																																																																				
RC1019A0	COLLIER ELASTIQUE D10 ZINGUE	2.000	PCS																																																																																																				
RC1243A0	Ø10F-Ø10M ELBOW CONNECTION + JG END KIT	1.000	PCS																																																																																																				
RC1360A0	10 - 10 JG ELBOW FITTIN	2.000	PCS																																																																																																				
RC1378A0	PINCE DURITE	1.000	PCS																																																																																																				



COMPOSANT			PIÈCE DE RECHANGE																																																																																													
Code	Description	Image	Code	Description	Composants du kit																																																																																											
RC1243A	Ø10F-Ø10M ELBOW CONNECTION + JG END KIT		KVL1315A	KIT RESERV RECIRC (SANS POMPE) CBX	<table border="1"> <thead> <tr> <th>Code</th> <th>Description</th> <th>Qté</th> <th>UOM</th> </tr> </thead> <tbody> <tr> <td>RC1410A0</td> <td>BANDE SERRAGE TUYAU D16-27 INOX</td> <td>2.000</td> <td>PCS</td> </tr> <tr> <td>SN1053A0</td> <td></td> <td>1.000</td> <td>PCS</td> </tr> <tr> <td>SN1061A0</td> <td>D4x175MM NTC PROBE</td> <td>1.000</td> <td>PCS</td> </tr> <tr> <td>TB3822A0</td> <td></td> <td>1.000</td> <td>PCS</td> </tr> <tr> <td>TB4135A0</td> <td></td> <td>1.000</td> <td>PCS</td> </tr> <tr> <td>TB4160A0</td> <td></td> <td>1.000</td> <td>PCS</td> </tr> <tr> <td>VI1103A0</td> <td>VIS POUR PLASTIQUE 40X12 TPBS+INOX</td> <td>6.000</td> <td>PCS</td> </tr> <tr> <td>VL1315A1</td> <td>ASM BLOCAGE RESERVOIR POMPE DID</td> <td>1.000</td> <td>PCS</td> </tr> <tr> <td>VL1340A0</td> <td>RACCORD BYPASS M-M JG10 DID</td> <td>1.000</td> <td>PCS</td> </tr> <tr> <td>VL1400A0</td> <td>COUDE ÉVACUATION BORD PARTIE</td> <td>1.000</td> <td>PCS</td> </tr> <tr> <td>VL1407A1</td> <td>ASM REDUCTEUR DID</td> <td>1.000</td> <td>PCS</td> </tr> <tr> <td>VM1802A0</td> <td>GOUPILLE DE ROTATION PORTE RÉSERVOIR DI</td> <td>1.000</td> <td>PCS</td> </tr> <tr> <td>VM2039A0</td> <td>ANNEAU FIXAGE COURBE DE DECHARGE</td> <td>1.000</td> <td>PCS</td> </tr> <tr> <td>VM2640A0</td> <td>PROTECTION POMPE D'ÉVACUATIO</td> <td>1.000</td> <td>PCS</td> </tr> </tbody> </table>	Code	Description	Qté	UOM	RC1410A0	BANDE SERRAGE TUYAU D16-27 INOX	2.000	PCS	SN1053A0		1.000	PCS	SN1061A0	D4x175MM NTC PROBE	1.000	PCS	TB3822A0		1.000	PCS	TB4135A0		1.000	PCS	TB4160A0		1.000	PCS	VI1103A0	VIS POUR PLASTIQUE 40X12 TPBS+INOX	6.000	PCS	VL1315A1	ASM BLOCAGE RESERVOIR POMPE DID	1.000	PCS	VL1340A0	RACCORD BYPASS M-M JG10 DID	1.000	PCS	VL1400A0	COUDE ÉVACUATION BORD PARTIE	1.000	PCS	VL1407A1	ASM REDUCTEUR DID	1.000	PCS	VM1802A0	GOUPILLE DE ROTATION PORTE RÉSERVOIR DI	1.000	PCS	VM2039A0	ANNEAU FIXAGE COURBE DE DECHARGE	1.000	PCS	VM2640A0	PROTECTION POMPE D'ÉVACUATIO	1.000	PCS	KVL1310A	KIT COMPLET GROUP RESERV RECIRC CBX	<table border="1"> <thead> <tr> <th>Code</th> <th>Description</th> <th>Qté</th> <th>UOM</th> </tr> </thead> <tbody> <tr> <td>0H5760A0</td> <td>COVER CONDENSATE UR CN1016</td> <td>1.000</td> <td>PCS</td> </tr> <tr> <td>0H6686A0</td> <td></td> <td>1.000</td> <td>PCS</td> </tr> <tr> <td>CE2054A0</td> <td>CABLE RAST 5 POMPE D'ÉVACUATIO</td> <td>1.000</td> <td>PCS</td> </tr> <tr> <td>CE2055A0</td> <td>CABLE RAST 5 POMPE RECIRCULATI ON</td> <td>1.000</td> <td>PCS</td> </tr> <tr> <td>CN1016A0</td> <td>CONDENSATE UR 2.5 µF 500V CE/UL</td> <td>1.000</td> <td>PCS</td> </tr> <tr> <td>GN1400A0</td> <td>U-TRAP SEAL</td> <td>1.000</td> <td>PCS</td> </tr> </tbody> </table>	Code	Description	Qté	UOM	0H5760A0	COVER CONDENSATE UR CN1016	1.000	PCS	0H6686A0		1.000	PCS	CE2054A0	CABLE RAST 5 POMPE D'ÉVACUATIO	1.000	PCS	CE2055A0	CABLE RAST 5 POMPE RECIRCULATI ON	1.000	PCS	CN1016A0	CONDENSATE UR 2.5 µF 500V CE/UL	1.000	PCS	GN1400A0	U-TRAP SEAL	1.000	PCS
			Code	Description	Qté	UOM																																																																																										
RC1410A0	BANDE SERRAGE TUYAU D16-27 INOX	2.000	PCS																																																																																													
SN1053A0		1.000	PCS																																																																																													
SN1061A0	D4x175MM NTC PROBE	1.000	PCS																																																																																													
TB3822A0		1.000	PCS																																																																																													
TB4135A0		1.000	PCS																																																																																													
TB4160A0		1.000	PCS																																																																																													
VI1103A0	VIS POUR PLASTIQUE 40X12 TPBS+INOX	6.000	PCS																																																																																													
VL1315A1	ASM BLOCAGE RESERVOIR POMPE DID	1.000	PCS																																																																																													
VL1340A0	RACCORD BYPASS M-M JG10 DID	1.000	PCS																																																																																													
VL1400A0	COUDE ÉVACUATION BORD PARTIE	1.000	PCS																																																																																													
VL1407A1	ASM REDUCTEUR DID	1.000	PCS																																																																																													
VM1802A0	GOUPILLE DE ROTATION PORTE RÉSERVOIR DI	1.000	PCS																																																																																													
VM2039A0	ANNEAU FIXAGE COURBE DE DECHARGE	1.000	PCS																																																																																													
VM2640A0	PROTECTION POMPE D'ÉVACUATIO	1.000	PCS																																																																																													
Code	Description	Qté	UOM																																																																																													
0H5760A0	COVER CONDENSATE UR CN1016	1.000	PCS																																																																																													
0H6686A0		1.000	PCS																																																																																													
CE2054A0	CABLE RAST 5 POMPE D'ÉVACUATIO	1.000	PCS																																																																																													
CE2055A0	CABLE RAST 5 POMPE RECIRCULATI ON	1.000	PCS																																																																																													
CN1016A0	CONDENSATE UR 2.5 µF 500V CE/UL	1.000	PCS																																																																																													
GN1400A0	U-TRAP SEAL	1.000	PCS																																																																																													

COMPOSANT			PIÈCE DE RECHANGE																																																																																										
Code	Description	Image	Code	Description	Composants du kit																																																																																								
RC1243A	Ø10F-Ø10M ELBOW CONNECTION + JG END KIT		KVL1310A	KIT COMPLET GROUP RESERV RECIRC CBX	<table border="1"> <thead> <tr> <th>Code</th> <th>Description</th> <th>Qté</th> <th>UOM</th> </tr> </thead> <tbody> <tr> <td>PM1013A0</td> <td>240V 32W DRAIN PUMP</td> <td>1.000</td> <td>PCS</td> </tr> <tr> <td>PM1018A0</td> <td>POMPE RECYCLAGE 240V 100W</td> <td>1.000</td> <td>PCS</td> </tr> <tr> <td>RC1019A0</td> <td>COLLIER ELASTIQUE D10 ZINGUE</td> <td>2.000</td> <td>PCS</td> </tr> <tr> <td>RC1046A0</td> <td>COLLIER DE SERRAGE TUBE D10-16 H9 INOX</td> <td>1.000</td> <td>PCS</td> </tr> <tr> <td>RC1360A0</td> <td>10 - 10 JG ELBOW FITTIN</td> <td>2.000</td> <td>PCS</td> </tr> <tr> <td>RC1378A0</td> <td>PINCE DURITE</td> <td>1.000</td> <td>PCS</td> </tr> <tr> <td>RC1410A0</td> <td>BANDE SERRAGE TUYAU D16-27 INOX</td> <td>6.000</td> <td>PCS</td> </tr> <tr> <td>SN1053A0</td> <td></td> <td>1.000</td> <td>PCS</td> </tr> <tr> <td>SN1061A0</td> <td>D4x175MM NTC PROBE</td> <td>1.000</td> <td>PCS</td> </tr> <tr> <td>TB3822A0</td> <td></td> <td>2.000</td> <td>PCS</td> </tr> <tr> <td>TB4135A0</td> <td></td> <td>1.000</td> <td>PCS</td> </tr> <tr> <td>TB4160A0</td> <td></td> <td>1.000</td> <td>PCS</td> </tr> <tr> <td>VI1103A0</td> <td>VIS POUR PLASTIQUE 40X12 TPBS+INOX</td> <td>9.000</td> <td>PCS</td> </tr> <tr> <td>VI1220A1</td> <td>VIS AUTOTARADE UX 4.2x12 TCB MARUTEX PRE</td> <td>2.000</td> <td>PCS</td> </tr> <tr> <td>VI1931A0</td> <td>ECROU M6x1,65 H4 CH13 ZINGUE</td> <td>1.000</td> <td>PCS</td> </tr> <tr> <td>VL1178A0</td> <td>O RING D INTERIEUR 10,8 CORDE 1,78 EPDM</td> <td>2.000</td> <td>PCS</td> </tr> <tr> <td>VL1315A1</td> <td>ASM BLOCAGE RESERVOIR POMPE DID</td> <td>1.000</td> <td>PCS</td> </tr> <tr> <td>VL1318A0</td> <td>SUPPORT POMPE DE RECIRCULATI ON DID</td> <td>1.000</td> <td>PCS</td> </tr> <tr> <td>VL1329A0</td> <td>RACCORD D24-D16</td> <td>1.000</td> <td>PCS</td> </tr> <tr> <td>VL1332A0</td> <td>BOUCHON RESERVOIR DI</td> <td>1.000</td> <td>PCS</td> </tr> <tr> <td>VL1340A0</td> <td>RACCORD BYPASS M-M JG10 DID</td> <td>1.000</td> <td>PCS</td> </tr> </tbody> </table>	Code	Description	Qté	UOM	PM1013A0	240V 32W DRAIN PUMP	1.000	PCS	PM1018A0	POMPE RECYCLAGE 240V 100W	1.000	PCS	RC1019A0	COLLIER ELASTIQUE D10 ZINGUE	2.000	PCS	RC1046A0	COLLIER DE SERRAGE TUBE D10-16 H9 INOX	1.000	PCS	RC1360A0	10 - 10 JG ELBOW FITTIN	2.000	PCS	RC1378A0	PINCE DURITE	1.000	PCS	RC1410A0	BANDE SERRAGE TUYAU D16-27 INOX	6.000	PCS	SN1053A0		1.000	PCS	SN1061A0	D4x175MM NTC PROBE	1.000	PCS	TB3822A0		2.000	PCS	TB4135A0		1.000	PCS	TB4160A0		1.000	PCS	VI1103A0	VIS POUR PLASTIQUE 40X12 TPBS+INOX	9.000	PCS	VI1220A1	VIS AUTOTARADE UX 4.2x12 TCB MARUTEX PRE	2.000	PCS	VI1931A0	ECROU M6x1,65 H4 CH13 ZINGUE	1.000	PCS	VL1178A0	O RING D INTERIEUR 10,8 CORDE 1,78 EPDM	2.000	PCS	VL1315A1	ASM BLOCAGE RESERVOIR POMPE DID	1.000	PCS	VL1318A0	SUPPORT POMPE DE RECIRCULATI ON DID	1.000	PCS	VL1329A0	RACCORD D24-D16	1.000	PCS	VL1332A0	BOUCHON RESERVOIR DI	1.000	PCS	VL1340A0	RACCORD BYPASS M-M JG10 DID	1.000	PCS
Code	Description	Qté	UOM																																																																																										
PM1013A0	240V 32W DRAIN PUMP	1.000	PCS																																																																																										
PM1018A0	POMPE RECYCLAGE 240V 100W	1.000	PCS																																																																																										
RC1019A0	COLLIER ELASTIQUE D10 ZINGUE	2.000	PCS																																																																																										
RC1046A0	COLLIER DE SERRAGE TUBE D10-16 H9 INOX	1.000	PCS																																																																																										
RC1360A0	10 - 10 JG ELBOW FITTIN	2.000	PCS																																																																																										
RC1378A0	PINCE DURITE	1.000	PCS																																																																																										
RC1410A0	BANDE SERRAGE TUYAU D16-27 INOX	6.000	PCS																																																																																										
SN1053A0		1.000	PCS																																																																																										
SN1061A0	D4x175MM NTC PROBE	1.000	PCS																																																																																										
TB3822A0		2.000	PCS																																																																																										
TB4135A0		1.000	PCS																																																																																										
TB4160A0		1.000	PCS																																																																																										
VI1103A0	VIS POUR PLASTIQUE 40X12 TPBS+INOX	9.000	PCS																																																																																										
VI1220A1	VIS AUTOTARADE UX 4.2x12 TCB MARUTEX PRE	2.000	PCS																																																																																										
VI1931A0	ECROU M6x1,65 H4 CH13 ZINGUE	1.000	PCS																																																																																										
VL1178A0	O RING D INTERIEUR 10,8 CORDE 1,78 EPDM	2.000	PCS																																																																																										
VL1315A1	ASM BLOCAGE RESERVOIR POMPE DID	1.000	PCS																																																																																										
VL1318A0	SUPPORT POMPE DE RECIRCULATI ON DID	1.000	PCS																																																																																										
VL1329A0	RACCORD D24-D16	1.000	PCS																																																																																										
VL1332A0	BOUCHON RESERVOIR DI	1.000	PCS																																																																																										
VL1340A0	RACCORD BYPASS M-M JG10 DID	1.000	PCS																																																																																										

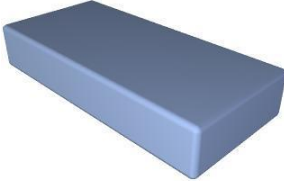
COMPOSANT			PIÈCE DE RECHANGE																																															
Code	Description	Image	Code	Description	Composants du kit																																													
RC1243A	Ø10F-Ø10M ELBOW CONNECTION + JG END KIT		KVL1310A	KIT COMPLET GROUP RESERV RECIRC CBX	<table border="1"> <thead> <tr> <th>Code</th> <th>Description</th> <th>Qté</th> <th>UOM</th> </tr> </thead> <tbody> <tr> <td>VL1400A0</td> <td>COUDE ÉVACUATION BORD PARTIE</td> <td>1.000</td> <td>PCS</td> </tr> <tr> <td>VL1407A1</td> <td>ASM REDUCTEUR DID</td> <td>1.000</td> <td>PCS</td> </tr> <tr> <td>VM1794A0</td> <td>PLAQUETTE NOIRE 250X4.8 PA66</td> <td>1.000</td> <td>PCS</td> </tr> <tr> <td>VM1802A0</td> <td>GOUPILLE DE ROTATION PORTE RÉSERVOIR DI</td> <td>1.000</td> <td>PCS</td> </tr> <tr> <td>VM2039A0</td> <td>ANNEAU FIXAGE COURBE DE DECHARGE</td> <td>1.000</td> <td>PCS</td> </tr> <tr> <td>VM2640A0</td> <td>PROTECTION POMPE D'ÉVACUATIO</td> <td>1.000</td> <td>PCS</td> </tr> </tbody> </table>	Code	Description	Qté	UOM	VL1400A0	COUDE ÉVACUATION BORD PARTIE	1.000	PCS	VL1407A1	ASM REDUCTEUR DID	1.000	PCS	VM1794A0	PLAQUETTE NOIRE 250X4.8 PA66	1.000	PCS	VM1802A0	GOUPILLE DE ROTATION PORTE RÉSERVOIR DI	1.000	PCS	VM2039A0	ANNEAU FIXAGE COURBE DE DECHARGE	1.000	PCS	VM2640A0	PROTECTION POMPE D'ÉVACUATIO	1.000	PCS																	
			Code	Description	Qté	UOM																																												
VL1400A0	COUDE ÉVACUATION BORD PARTIE	1.000	PCS																																															
VL1407A1	ASM REDUCTEUR DID	1.000	PCS																																															
VM1794A0	PLAQUETTE NOIRE 250X4.8 PA66	1.000	PCS																																															
VM1802A0	GOUPILLE DE ROTATION PORTE RÉSERVOIR DI	1.000	PCS																																															
VM2039A0	ANNEAU FIXAGE COURBE DE DECHARGE	1.000	PCS																																															
VM2640A0	PROTECTION POMPE D'ÉVACUATIO	1.000	PCS																																															
KVL1163A	KIT RACCORDMENT HYDRIQUE MM	<table border="1"> <thead> <tr> <th>Code</th> <th>Description</th> <th>Qté</th> <th>UOM</th> </tr> </thead> <tbody> <tr> <td>0H8038A0</td> <td>TOLE SUPPORT REDUCTEUR MM</td> <td>1.000</td> <td>PCS</td> </tr> <tr> <td>0H8039A0</td> <td>TOLE SUPPORT REDUCTEUR COMPACT MM</td> <td>1.000</td> <td>PCS</td> </tr> <tr> <td>CH1026A0</td> <td>CLÉ JOHN GUEST UNOX Ø8-Ø10</td> <td>1.000</td> <td>PCS</td> </tr> <tr> <td>RC1243A0</td> <td>Ø10F-Ø10M ELBOW CONNECTION + JG END KIT</td> <td>2.000</td> <td>PCS</td> </tr> <tr> <td>RC1396A0</td> <td>EXTREMITÉ DROITE JG D10-1/4</td> <td>2.000</td> <td>PCS</td> </tr> <tr> <td>TB2243A0</td> <td>TUYAU DIAMETRE 10 TRANSPAREN</td> <td>1.500</td> <td>M</td> </tr> <tr> <td>VI1220A1</td> <td>VIS AUTOTARADE UX 4.2x12 TCB MARUTEX PRE</td> <td>2.000</td> <td>PCS</td> </tr> <tr> <td>VI1950A0</td> <td>VIS AUTOPERCEU SE 4.2X13 TCB INOX</td> <td>1.000</td> <td>PCS</td> </tr> <tr> <td>VL1014B3</td> <td></td> <td>1.000</td> <td>PCS</td> </tr> <tr> <td>VL1135A1</td> <td>3/4-JG10 CONNECTOR + FILTER AND NRV</td> <td>1.000</td> <td>PCS</td> </tr> <tr> <td>VM1054A0</td> <td>BAGUE REDUCTEUR DE PRESSION H7.8</td> <td>1.000</td> <td>PCS</td> </tr> </tbody> </table>	Code	Description	Qté	UOM	0H8038A0	TOLE SUPPORT REDUCTEUR MM	1.000	PCS	0H8039A0	TOLE SUPPORT REDUCTEUR COMPACT MM	1.000	PCS	CH1026A0	CLÉ JOHN GUEST UNOX Ø8-Ø10	1.000	PCS	RC1243A0	Ø10F-Ø10M ELBOW CONNECTION + JG END KIT	2.000	PCS	RC1396A0	EXTREMITÉ DROITE JG D10-1/4	2.000	PCS	TB2243A0	TUYAU DIAMETRE 10 TRANSPAREN	1.500	M	VI1220A1	VIS AUTOTARADE UX 4.2x12 TCB MARUTEX PRE	2.000	PCS	VI1950A0	VIS AUTOPERCEU SE 4.2X13 TCB INOX	1.000	PCS	VL1014B3		1.000	PCS	VL1135A1	3/4-JG10 CONNECTOR + FILTER AND NRV	1.000	PCS	VM1054A0	BAGUE REDUCTEUR DE PRESSION H7.8	1.000	PCS
Code	Description	Qté	UOM																																															
0H8038A0	TOLE SUPPORT REDUCTEUR MM	1.000	PCS																																															
0H8039A0	TOLE SUPPORT REDUCTEUR COMPACT MM	1.000	PCS																																															
CH1026A0	CLÉ JOHN GUEST UNOX Ø8-Ø10	1.000	PCS																																															
RC1243A0	Ø10F-Ø10M ELBOW CONNECTION + JG END KIT	2.000	PCS																																															
RC1396A0	EXTREMITÉ DROITE JG D10-1/4	2.000	PCS																																															
TB2243A0	TUYAU DIAMETRE 10 TRANSPAREN	1.500	M																																															
VI1220A1	VIS AUTOTARADE UX 4.2x12 TCB MARUTEX PRE	2.000	PCS																																															
VI1950A0	VIS AUTOPERCEU SE 4.2X13 TCB INOX	1.000	PCS																																															
VL1014B3		1.000	PCS																																															
VL1135A1	3/4-JG10 CONNECTOR + FILTER AND NRV	1.000	PCS																																															
VM1054A0	BAGUE REDUCTEUR DE PRESSION H7.8	1.000	PCS																																															



COMPOSANT			PIÈCE DE RECHANGE																						
Code	Description	Image	Code	Description	Composants du kit																				
RC1243A	Ø10F-Ø10M ELBOW CONNECTION + JG END KIT		KRC1243A	KIT 10 PCS RACCORD COUDE QUEUE D10F-D10M	<table border="1"> <thead> <tr> <th>Code</th> <th>Description</th> <th>Qté</th> <th>UOM</th> </tr> </thead> <tbody> <tr> <td>RC1243A0</td> <td>Ø10F-Ø10M ELBOW CONNECTION + JG END KIT</td> <td>10.000</td> <td>PCS</td> </tr> </tbody> </table>	Code	Description	Qté	UOM	RC1243A0	Ø10F-Ø10M ELBOW CONNECTION + JG END KIT	10.000	PCS												
Code	Description	Qté	UOM																						
RC1243A0	Ø10F-Ø10M ELBOW CONNECTION + JG END KIT	10.000	PCS																						
RC1365A	3/4"-10 JG FEMALE CONNECTION		KVL1145A KVL1135A	KIT RACCORD 3/4-JG8 AVEC FILTRE ET VNR KIT RACCORD 3/4-JG10 AVEC FILTRE ET VNR	<table border="1"> <thead> <tr> <th>Code</th> <th>Description</th> <th>Qté</th> <th>UOM</th> </tr> </thead> <tbody> <tr> <td>VL1145A1</td> <td></td> <td>1.000</td> <td>PCS</td> </tr> </tbody> </table> <table border="1"> <thead> <tr> <th>Code</th> <th>Description</th> <th>Qté</th> <th>UOM</th> </tr> </thead> <tbody> <tr> <td>RC1360A0</td> <td>10 - 10 JG ELBOW FITTING</td> <td>1.000</td> <td>PCS</td> </tr> <tr> <td>VL1135A1</td> <td>3/4-JG10 CONNECTOR + FILTER AND NRV</td> <td>1.000</td> <td>PCS</td> </tr> </tbody> </table>	Code	Description	Qté	UOM	VL1145A1		1.000	PCS	Code	Description	Qté	UOM	RC1360A0	10 - 10 JG ELBOW FITTING	1.000	PCS	VL1135A1	3/4-JG10 CONNECTOR + FILTER AND NRV	1.000	PCS
Code	Description	Qté	UOM																						
VL1145A1		1.000	PCS																						
Code	Description	Qté	UOM																						
RC1360A0	10 - 10 JG ELBOW FITTING	1.000	PCS																						
VL1135A1	3/4-JG10 CONNECTOR + FILTER AND NRV	1.000	PCS																						
TB1099A	TB3130A-D10 WATER CONNECTING PIPE		KTB2599A KTB2598A	KIT TUYAU PET D10 L=100M TB2243A KIT TUBE PET D10 L=3M TB2243A0	<table border="1"> <thead> <tr> <th>Code</th> <th>Description</th> <th>Qté</th> <th>UOM</th> </tr> </thead> <tbody> <tr> <td>TB2243A0</td> <td>TUYAU DIAMETRE 10 TRANSPAREN</td> <td>100.000</td> <td>M</td> </tr> </tbody> </table> <table border="1"> <thead> <tr> <th>Code</th> <th>Description</th> <th>Qté</th> <th>UOM</th> </tr> </thead> <tbody> <tr> <td>TB2243A0</td> <td>TUYAU DIAMETRE 10 TRANSPAREN</td> <td>3.000</td> <td>M</td> </tr> </tbody> </table>	Code	Description	Qté	UOM	TB2243A0	TUYAU DIAMETRE 10 TRANSPAREN	100.000	M	Code	Description	Qté	UOM	TB2243A0	TUYAU DIAMETRE 10 TRANSPAREN	3.000	M				
Code	Description	Qté	UOM																						
TB2243A0	TUYAU DIAMETRE 10 TRANSPAREN	100.000	M																						
Code	Description	Qté	UOM																						
TB2243A0	TUYAU DIAMETRE 10 TRANSPAREN	3.000	M																						
VL1034C	MESH WATER FILTER D10		KVL1135A	KIT RACCORD 3/4-JG10 AVEC FILTRE ET VNR	<table border="1"> <thead> <tr> <th>Code</th> <th>Description</th> <th>Qté</th> <th>UOM</th> </tr> </thead> <tbody> <tr> <td>RC1360A0</td> <td>10 - 10 JG ELBOW FITTING</td> <td>1.000</td> <td>PCS</td> </tr> <tr> <td>VL1135A1</td> <td>3/4-JG10 CONNECTOR + FILTER AND NRV</td> <td>1.000</td> <td>PCS</td> </tr> </tbody> </table>	Code	Description	Qté	UOM	RC1360A0	10 - 10 JG ELBOW FITTING	1.000	PCS	VL1135A1	3/4-JG10 CONNECTOR + FILTER AND NRV	1.000	PCS								
Code	Description	Qté	UOM																						
RC1360A0	10 - 10 JG ELBOW FITTING	1.000	PCS																						
VL1135A1	3/4-JG10 CONNECTOR + FILTER AND NRV	1.000	PCS																						
VL1062C	PRESSURE REDUCER-FILTER LOCKING FORK		KVL1163A	KIT RACCORDEMENT HYDRIQUE MM	<table border="1"> <thead> <tr> <th>Code</th> <th>Description</th> <th>Qté</th> <th>UOM</th> </tr> </thead> <tbody> <tr> <td>0H8038A0</td> <td>TOLE SUPPORT REDUCTEUR MM</td> <td>1.000</td> <td>PCS</td> </tr> <tr> <td>0H8039A0</td> <td>TOLE SUPPORT REDUCTEUR COMPACT MM</td> <td>1.000</td> <td>PCS</td> </tr> <tr> <td>CH1026A0</td> <td>CLÉ JOHN GUEST UNOX Ø8-Ø10</td> <td>1.000</td> <td>PCS</td> </tr> </tbody> </table>	Code	Description	Qté	UOM	0H8038A0	TOLE SUPPORT REDUCTEUR MM	1.000	PCS	0H8039A0	TOLE SUPPORT REDUCTEUR COMPACT MM	1.000	PCS	CH1026A0	CLÉ JOHN GUEST UNOX Ø8-Ø10	1.000	PCS				
Code	Description	Qté	UOM																						
0H8038A0	TOLE SUPPORT REDUCTEUR MM	1.000	PCS																						
0H8039A0	TOLE SUPPORT REDUCTEUR COMPACT MM	1.000	PCS																						
CH1026A0	CLÉ JOHN GUEST UNOX Ø8-Ø10	1.000	PCS																						

COMPOSANT			PIÈCE DE RECHANGE																																						
Code	Description	Image	Code	Description	Composants du kit																																				
VL1062C	PRESSURE REDUCER-FILTER LOCKING FORK		KVL1163A	KIT RACCORDEMENT HYDRIQUE MM	<table border="1"> <thead> <tr> <th>Code</th> <th>Description</th> <th>Qté</th> <th>UOM</th> </tr> </thead> <tbody> <tr> <td>RC1243A0</td> <td>Ø10F-Ø10M ELBOW CONNECTION + JG END KIT</td> <td>2.000</td> <td>PCS</td> </tr> <tr> <td>RC1396A0</td> <td>EXTREMITE DROITE JG D10-1/4</td> <td>2.000</td> <td>PCS</td> </tr> <tr> <td>TB2243A0</td> <td>TUYAU DIAMETRE 10 TRANSPAREN</td> <td>1.500</td> <td>M</td> </tr> <tr> <td>VI1220A1</td> <td>VIS AUTOTARADE UX 4.2x12 TCB MARUTEX PRE</td> <td>2.000</td> <td>PCS</td> </tr> <tr> <td>VI1950A0</td> <td>VIS AUTOPERCEU SE 4.2X13 TCB INOX</td> <td>1.000</td> <td>PCS</td> </tr> <tr> <td>VL1014B3</td> <td></td> <td>1.000</td> <td>PCS</td> </tr> <tr> <td>VL1135A1</td> <td>3/4-JG10 CONNECTOR + FILTER AND NRV</td> <td>1.000</td> <td>PCS</td> </tr> <tr> <td>VM1054A0</td> <td>BAGUE REDUCTEUR DE PRESSION H7.8</td> <td>1.000</td> <td>PCS</td> </tr> </tbody> </table>	Code	Description	Qté	UOM	RC1243A0	Ø10F-Ø10M ELBOW CONNECTION + JG END KIT	2.000	PCS	RC1396A0	EXTREMITE DROITE JG D10-1/4	2.000	PCS	TB2243A0	TUYAU DIAMETRE 10 TRANSPAREN	1.500	M	VI1220A1	VIS AUTOTARADE UX 4.2x12 TCB MARUTEX PRE	2.000	PCS	VI1950A0	VIS AUTOPERCEU SE 4.2X13 TCB INOX	1.000	PCS	VL1014B3		1.000	PCS	VL1135A1	3/4-JG10 CONNECTOR + FILTER AND NRV	1.000	PCS	VM1054A0	BAGUE REDUCTEUR DE PRESSION H7.8	1.000	PCS
Code	Description	Qté	UOM																																						
RC1243A0	Ø10F-Ø10M ELBOW CONNECTION + JG END KIT	2.000	PCS																																						
RC1396A0	EXTREMITE DROITE JG D10-1/4	2.000	PCS																																						
TB2243A0	TUYAU DIAMETRE 10 TRANSPAREN	1.500	M																																						
VI1220A1	VIS AUTOTARADE UX 4.2x12 TCB MARUTEX PRE	2.000	PCS																																						
VI1950A0	VIS AUTOPERCEU SE 4.2X13 TCB INOX	1.000	PCS																																						
VL1014B3		1.000	PCS																																						
VL1135A1	3/4-JG10 CONNECTOR + FILTER AND NRV	1.000	PCS																																						
VM1054A0	BAGUE REDUCTEUR DE PRESSION H7.8	1.000	PCS																																						
VL1086A	AIMANT NEODYME ANTICALCAIRE		KVL1086A	KIT AIMANT NEODYME ANTICALCAIRE																																					
VL1096A	2 PCS RACCORD T-PORTEGOM D6-D10-AIMAN		KVL1483A	KIT ASM RACCORDO A T CON MAGNETI	<table border="1"> <thead> <tr> <th>Code</th> <th>Description</th> <th>Qté</th> <th>UOM</th> </tr> </thead> <tbody> <tr> <td>GN1526A0</td> <td>O-RING D.INT6.9 SP1.8</td> <td>1.000</td> <td>PCS</td> </tr> <tr> <td>RC1414A1</td> <td>COLLIER A COMPRESSIO N D11.5-12.5</td> <td>2.000</td> <td>PCS</td> </tr> <tr> <td>TB4131A0</td> <td></td> <td>1.000</td> <td>PCS</td> </tr> <tr> <td>VL1166A0</td> <td>RACCORD EN L BB6-AL6</td> <td>1.000</td> <td>PCS</td> </tr> <tr> <td>VL1277A0</td> <td>CLIP RACCORD BAIONETTE POLYMERE</td> <td>1.000</td> <td>PCS</td> </tr> <tr> <td>VL1483A0</td> <td>ENSEMBLE RACCORD T AVEC AIMANT</td> <td>1.000</td> <td>PCS</td> </tr> </tbody> </table>	Code	Description	Qté	UOM	GN1526A0	O-RING D.INT6.9 SP1.8	1.000	PCS	RC1414A1	COLLIER A COMPRESSIO N D11.5-12.5	2.000	PCS	TB4131A0		1.000	PCS	VL1166A0	RACCORD EN L BB6-AL6	1.000	PCS	VL1277A0	CLIP RACCORD BAIONETTE POLYMERE	1.000	PCS	VL1483A0	ENSEMBLE RACCORD T AVEC AIMANT	1.000	PCS								
Code	Description	Qté	UOM																																						
GN1526A0	O-RING D.INT6.9 SP1.8	1.000	PCS																																						
RC1414A1	COLLIER A COMPRESSIO N D11.5-12.5	2.000	PCS																																						
TB4131A0		1.000	PCS																																						
VL1166A0	RACCORD EN L BB6-AL6	1.000	PCS																																						
VL1277A0	CLIP RACCORD BAIONETTE POLYMERE	1.000	PCS																																						
VL1483A0	ENSEMBLE RACCORD T AVEC AIMANT	1.000	PCS																																						

COMPOSANT			PIÈCE DE RECHANGE																																							
Code	Description	Image	Code	Description	Composants du kit																																					
VM1054A	BAGUE REDUCTEUR DE PRESSION H7.8		KVM1054A	KIT BAGUE REDUCTEUR DE PRESSION	<table border="1"> <thead> <tr> <th>Code</th> <th>Description</th> <th>Qté</th> <th>UOM</th> </tr> </thead> <tbody> <tr> <td>VM1054A0</td> <td>BAGUE REDUCTEUR DE PRESSION H7.8</td> <td>1.000</td> <td>PCS</td> </tr> </tbody> </table>	Code	Description	Qté	UOM	VM1054A0	BAGUE REDUCTEUR DE PRESSION H7.8	1.000	PCS																													
			Code	Description	Qté	UOM																																				
VM1054A0	BAGUE REDUCTEUR DE PRESSION H7.8	1.000	PCS																																							
KVL1117A	KIT FILTRE RED. PRESS. EUR MM 2016+LMTop	<table border="1"> <thead> <tr> <th>Code</th> <th>Description</th> <th>Qté</th> <th>UOM</th> </tr> </thead> <tbody> <tr> <td>0H7472A1</td> <td>DISTRIBUTOR SUPPORT PLATE</td> <td>1.000</td> <td>PCS</td> </tr> <tr> <td>RC1004A0</td> <td>Ø10-Ø8-8 Y CONNECTION</td> <td>1.000</td> <td>PCS</td> </tr> <tr> <td>RC1243A0</td> <td>Ø10F-Ø10M ELBOW CONNECTION + JG END KIT</td> <td>1.000</td> <td>PCS</td> </tr> <tr> <td>RC1372A0</td> <td>RACCORD DROIT Ø10M-1/4 M CI</td> <td>2.000</td> <td>PCS</td> </tr> <tr> <td>VI1220A1</td> <td>VIS AUTOTARADE UX 4.2x12 TCB MARUTEX PRE</td> <td>4.000</td> <td>PCS</td> </tr> <tr> <td>VL1014B3</td> <td></td> <td>1.000</td> <td>PCS</td> </tr> <tr> <td>VL1034C0</td> <td>MESH WATER FILTER D10</td> <td>1.000</td> <td>PCS</td> </tr> <tr> <td>VL1062C0</td> <td>PRESSURE REDUCER-FILTER LOCKING FORK</td> <td>1.000</td> <td>PCS</td> </tr> <tr> <td>VM1054A0</td> <td>BAGUE REDUCTEUR DE PRESSION H7.8</td> <td>1.000</td> <td>PCS</td> </tr> </tbody> </table>	Code	Description	Qté	UOM	0H7472A1	DISTRIBUTOR SUPPORT PLATE	1.000	PCS	RC1004A0	Ø10-Ø8-8 Y CONNECTION	1.000	PCS	RC1243A0	Ø10F-Ø10M ELBOW CONNECTION + JG END KIT	1.000	PCS	RC1372A0	RACCORD DROIT Ø10M-1/4 M CI	2.000	PCS	VI1220A1	VIS AUTOTARADE UX 4.2x12 TCB MARUTEX PRE	4.000	PCS	VL1014B3		1.000	PCS	VL1034C0	MESH WATER FILTER D10	1.000	PCS	VL1062C0	PRESSURE REDUCER-FILTER LOCKING FORK	1.000	PCS	VM1054A0	BAGUE REDUCTEUR DE PRESSION H7.8	1.000	PCS
Code	Description	Qté	UOM																																							
0H7472A1	DISTRIBUTOR SUPPORT PLATE	1.000	PCS																																							
RC1004A0	Ø10-Ø8-8 Y CONNECTION	1.000	PCS																																							
RC1243A0	Ø10F-Ø10M ELBOW CONNECTION + JG END KIT	1.000	PCS																																							
RC1372A0	RACCORD DROIT Ø10M-1/4 M CI	2.000	PCS																																							
VI1220A1	VIS AUTOTARADE UX 4.2x12 TCB MARUTEX PRE	4.000	PCS																																							
VL1014B3		1.000	PCS																																							
VL1034C0	MESH WATER FILTER D10	1.000	PCS																																							
VL1062C0	PRESSURE REDUCER-FILTER LOCKING FORK	1.000	PCS																																							
VM1054A0	BAGUE REDUCTEUR DE PRESSION H7.8	1.000	PCS																																							
VL1026A	COURBE POUR TUYAU DECHARGE		KVL1026A	KIT COURBE POUR TUYAU DECHARGE	<table border="1"> <thead> <tr> <th>Code</th> <th>Description</th> <th>Qté</th> <th>UOM</th> </tr> </thead> <tbody> <tr> <td>GN1400A0</td> <td>U-TRAP SEAL</td> <td>1.000</td> <td>PCS</td> </tr> <tr> <td>VL1026A0</td> <td>COURBE POUR TUYAU DECHARGE</td> <td>1.000</td> <td>PCS</td> </tr> <tr> <td>VM2039A0</td> <td>ANNEAU FIXAGE COURBE DE DECHARGE</td> <td>1.000</td> <td>PCS</td> </tr> </tbody> </table>	Code	Description	Qté	UOM	GN1400A0	U-TRAP SEAL	1.000	PCS	VL1026A0	COURBE POUR TUYAU DECHARGE	1.000	PCS	VM2039A0	ANNEAU FIXAGE COURBE DE DECHARGE	1.000	PCS																					
			Code	Description	Qté	UOM																																				
			GN1400A0	U-TRAP SEAL	1.000	PCS																																				
VL1026A0	COURBE POUR TUYAU DECHARGE	1.000	PCS																																							
VM2039A0	ANNEAU FIXAGE COURBE DE DECHARGE	1.000	PCS																																							
VM2039A	ANNEAU FIXAGE COURBE DE DECHARGE		KVL1315A	KIT RESERV RECIRC (SANS POMPE) CBX	<table border="1"> <thead> <tr> <th>Code</th> <th>Description</th> <th>Qté</th> <th>UOM</th> </tr> </thead> <tbody> <tr> <td>0H6686A0</td> <td></td> <td>1.000</td> <td>PCS</td> </tr> <tr> <td>GN1400A0</td> <td>U-TRAP SEAL</td> <td>1.000</td> <td>PCS</td> </tr> <tr> <td>RC1019A0</td> <td>COLLIER ELASTIQUE D10 ZINGUE</td> <td>2.000</td> <td>PCS</td> </tr> <tr> <td>RC1243A0</td> <td>Ø10F-Ø10M ELBOW CONNECTION + JG END KIT</td> <td>1.000</td> <td>PCS</td> </tr> </tbody> </table>	Code	Description	Qté	UOM	0H6686A0		1.000	PCS	GN1400A0	U-TRAP SEAL	1.000	PCS	RC1019A0	COLLIER ELASTIQUE D10 ZINGUE	2.000	PCS	RC1243A0	Ø10F-Ø10M ELBOW CONNECTION + JG END KIT	1.000	PCS																	
Code	Description	Qté	UOM																																							
0H6686A0		1.000	PCS																																							
GN1400A0	U-TRAP SEAL	1.000	PCS																																							
RC1019A0	COLLIER ELASTIQUE D10 ZINGUE	2.000	PCS																																							
RC1243A0	Ø10F-Ø10M ELBOW CONNECTION + JG END KIT	1.000	PCS																																							

COMPOSANT			PIÈCE DE RECHANGE																																																																																													
Code	Description	Image	Code	Description	Composants du kit																																																																																											
VM2039A	ANNEAU FIXAGE COURBE DE DECHARGE		KVL1315A	KIT RESERV RECIRC (SANS POMPE) CBX	<table border="1"> <thead> <tr> <th>Code</th> <th>Description</th> <th>Qté</th> <th>UOM</th> </tr> </thead> <tbody> <tr> <td>RC1360A0</td> <td>10 - 10 JG ELBOW FITTING</td> <td>2.000</td> <td>PCS</td> </tr> <tr> <td>RC1378A0</td> <td>PINCE DURITE</td> <td>1.000</td> <td>PCS</td> </tr> <tr> <td>RC1410A0</td> <td>BANDE SERRAGE TUYAU D16-27 INOX</td> <td>2.000</td> <td>PCS</td> </tr> <tr> <td>SN1053A0</td> <td></td> <td>1.000</td> <td>PCS</td> </tr> <tr> <td>SN1061A0</td> <td>D4x175MM NTC PROBE</td> <td>1.000</td> <td>PCS</td> </tr> <tr> <td>TB3822A0</td> <td></td> <td>1.000</td> <td>PCS</td> </tr> <tr> <td>TB4135A0</td> <td></td> <td>1.000</td> <td>PCS</td> </tr> <tr> <td>TB4160A0</td> <td></td> <td>1.000</td> <td>PCS</td> </tr> <tr> <td>VI1103A0</td> <td>VIS POUR PLASTIQUE 40X12 TPBS+INOX</td> <td>6.000</td> <td>PCS</td> </tr> <tr> <td>VL1315A1</td> <td>ASM BLOCAGE RESERVOIR POMPE DID</td> <td>1.000</td> <td>PCS</td> </tr> <tr> <td>VL1340A0</td> <td>RACCORD BYPASS M-M JG10 DID</td> <td>1.000</td> <td>PCS</td> </tr> <tr> <td>VL1400A0</td> <td>COUDE ÉVACUATION BORD PARTIE</td> <td>1.000</td> <td>PCS</td> </tr> <tr> <td>VL1407A1</td> <td>ASM REDUCTEUR DID</td> <td>1.000</td> <td>PCS</td> </tr> <tr> <td>VM1802A0</td> <td>GOUPILLE DE ROTATION PORTE RESERVOIR DI</td> <td>1.000</td> <td>PCS</td> </tr> <tr> <td>VM2039A0</td> <td>ANNEAU FIXAGE COURBE DE DECHARGE</td> <td>1.000</td> <td>PCS</td> </tr> <tr> <td>VM2640A0</td> <td>PROTECTION POMPE D'ÉVACUATIO</td> <td>1.000</td> <td>PCS</td> </tr> </tbody> </table>	Code	Description	Qté	UOM	RC1360A0	10 - 10 JG ELBOW FITTING	2.000	PCS	RC1378A0	PINCE DURITE	1.000	PCS	RC1410A0	BANDE SERRAGE TUYAU D16-27 INOX	2.000	PCS	SN1053A0		1.000	PCS	SN1061A0	D4x175MM NTC PROBE	1.000	PCS	TB3822A0		1.000	PCS	TB4135A0		1.000	PCS	TB4160A0		1.000	PCS	VI1103A0	VIS POUR PLASTIQUE 40X12 TPBS+INOX	6.000	PCS	VL1315A1	ASM BLOCAGE RESERVOIR POMPE DID	1.000	PCS	VL1340A0	RACCORD BYPASS M-M JG10 DID	1.000	PCS	VL1400A0	COUDE ÉVACUATION BORD PARTIE	1.000	PCS	VL1407A1	ASM REDUCTEUR DID	1.000	PCS	VM1802A0	GOUPILLE DE ROTATION PORTE RESERVOIR DI	1.000	PCS	VM2039A0	ANNEAU FIXAGE COURBE DE DECHARGE	1.000	PCS	VM2640A0	PROTECTION POMPE D'ÉVACUATIO	1.000	PCS	KVL1310A	KIT COMPLET GROUP RESERV RECIRC CBX	<table border="1"> <thead> <tr> <th>Code</th> <th>Description</th> <th>Qté</th> <th>UOM</th> </tr> </thead> <tbody> <tr> <td>0H5760A0</td> <td>COVER CONDENSATE UR CN1016</td> <td>1.000</td> <td>PCS</td> </tr> <tr> <td>0H6686A0</td> <td></td> <td>1.000</td> <td>PCS</td> </tr> <tr> <td>CE2054A0</td> <td>CABLE RAST 5 POMPE D'ÉVACUATIO</td> <td>1.000</td> <td>PCS</td> </tr> <tr> <td>CE2055A0</td> <td>CABLE RAST 5 POMPE RECIRCULATI ON</td> <td>1.000</td> <td>PCS</td> </tr> </tbody> </table>	Code	Description	Qté	UOM	0H5760A0	COVER CONDENSATE UR CN1016	1.000	PCS	0H6686A0		1.000	PCS	CE2054A0	CABLE RAST 5 POMPE D'ÉVACUATIO	1.000	PCS	CE2055A0	CABLE RAST 5 POMPE RECIRCULATI ON	1.000	PCS
			Code	Description	Qté	UOM																																																																																										
RC1360A0	10 - 10 JG ELBOW FITTING	2.000	PCS																																																																																													
RC1378A0	PINCE DURITE	1.000	PCS																																																																																													
RC1410A0	BANDE SERRAGE TUYAU D16-27 INOX	2.000	PCS																																																																																													
SN1053A0		1.000	PCS																																																																																													
SN1061A0	D4x175MM NTC PROBE	1.000	PCS																																																																																													
TB3822A0		1.000	PCS																																																																																													
TB4135A0		1.000	PCS																																																																																													
TB4160A0		1.000	PCS																																																																																													
VI1103A0	VIS POUR PLASTIQUE 40X12 TPBS+INOX	6.000	PCS																																																																																													
VL1315A1	ASM BLOCAGE RESERVOIR POMPE DID	1.000	PCS																																																																																													
VL1340A0	RACCORD BYPASS M-M JG10 DID	1.000	PCS																																																																																													
VL1400A0	COUDE ÉVACUATION BORD PARTIE	1.000	PCS																																																																																													
VL1407A1	ASM REDUCTEUR DID	1.000	PCS																																																																																													
VM1802A0	GOUPILLE DE ROTATION PORTE RESERVOIR DI	1.000	PCS																																																																																													
VM2039A0	ANNEAU FIXAGE COURBE DE DECHARGE	1.000	PCS																																																																																													
VM2640A0	PROTECTION POMPE D'ÉVACUATIO	1.000	PCS																																																																																													
Code	Description	Qté	UOM																																																																																													
0H5760A0	COVER CONDENSATE UR CN1016	1.000	PCS																																																																																													
0H6686A0		1.000	PCS																																																																																													
CE2054A0	CABLE RAST 5 POMPE D'ÉVACUATIO	1.000	PCS																																																																																													
CE2055A0	CABLE RAST 5 POMPE RECIRCULATI ON	1.000	PCS																																																																																													

COMPOSANT			PIÈCE DE RECHANGE																																																																																										
Code	Description	Image	Code	Description	Composants du kit																																																																																								
VM2039A	ANNEAU FIXAGE COURBE DE DECHARGE		KVL1310A	KIT COMPLET GROUP RESERV RECIRC CBX	<table border="1"> <thead> <tr> <th>Code</th> <th>Description</th> <th>Qté</th> <th>UOM</th> </tr> </thead> <tbody> <tr> <td>CN1016A0</td> <td>CONDENSATE UR 2.5 µF 500V CE/UL</td> <td>1.000</td> <td>PCS</td> </tr> <tr> <td>GN1400A0</td> <td>U-TRAP SEAL</td> <td>1.000</td> <td>PCS</td> </tr> <tr> <td>PM1013A0</td> <td>240V 32W DRAIN PUMP</td> <td>1.000</td> <td>PCS</td> </tr> <tr> <td>PM1018A0</td> <td>POMPE RECYCLAGE 240V 100W</td> <td>1.000</td> <td>PCS</td> </tr> <tr> <td>RC1019A0</td> <td>COLLIER ELASTIQUE D10 ZINGUE</td> <td>2.000</td> <td>PCS</td> </tr> <tr> <td>RC1046A0</td> <td>COLLIER DE SERRAGE TUBE D10-16 H9 INOX</td> <td>1.000</td> <td>PCS</td> </tr> <tr> <td>RC1360A0</td> <td>10 - 10 JG ELBOW FITTIN</td> <td>2.000</td> <td>PCS</td> </tr> <tr> <td>RC1378A0</td> <td>PINCE DURITE</td> <td>1.000</td> <td>PCS</td> </tr> <tr> <td>RC1410A0</td> <td>BANDE SERRAGE TUYAU D16-27 INOX</td> <td>6.000</td> <td>PCS</td> </tr> <tr> <td>SN1053A0</td> <td></td> <td>1.000</td> <td>PCS</td> </tr> <tr> <td>SN1061A0</td> <td>D4x175MM NTC PROBE</td> <td>1.000</td> <td>PCS</td> </tr> <tr> <td>TB3822A0</td> <td></td> <td>2.000</td> <td>PCS</td> </tr> <tr> <td>TB4135A0</td> <td></td> <td>1.000</td> <td>PCS</td> </tr> <tr> <td>TB4160A0</td> <td></td> <td>1.000</td> <td>PCS</td> </tr> <tr> <td>VI1103A0</td> <td>VIS POUR PLASTIQUE 40X12 TPBS+INOX</td> <td>9.000</td> <td>PCS</td> </tr> <tr> <td>VI1220A1</td> <td>VIS AUTOTARADE UX 4.2x12 TCB MARUTEX PRE</td> <td>2.000</td> <td>PCS</td> </tr> <tr> <td>VI1931A0</td> <td>ECROU M8x1,65 H4 CH13 ZINGUE</td> <td>1.000</td> <td>PCS</td> </tr> <tr> <td>VL1178A0</td> <td>O RING D INTERIEUR 10,8 CORDE 1,78 EPDM</td> <td>2.000</td> <td>PCS</td> </tr> <tr> <td>VL1315A1</td> <td>ASM BLOCAGE RESERVOIR POMPE DID</td> <td>1.000</td> <td>PCS</td> </tr> <tr> <td>VL1318A0</td> <td>SUPPORT POMPE DE RECIRCULATI ON DID</td> <td>1.000</td> <td>PCS</td> </tr> <tr> <td>VL1329A0</td> <td>RACCORD D24-D16</td> <td>1.000</td> <td>PCS</td> </tr> </tbody> </table>	Code	Description	Qté	UOM	CN1016A0	CONDENSATE UR 2.5 µF 500V CE/UL	1.000	PCS	GN1400A0	U-TRAP SEAL	1.000	PCS	PM1013A0	240V 32W DRAIN PUMP	1.000	PCS	PM1018A0	POMPE RECYCLAGE 240V 100W	1.000	PCS	RC1019A0	COLLIER ELASTIQUE D10 ZINGUE	2.000	PCS	RC1046A0	COLLIER DE SERRAGE TUBE D10-16 H9 INOX	1.000	PCS	RC1360A0	10 - 10 JG ELBOW FITTIN	2.000	PCS	RC1378A0	PINCE DURITE	1.000	PCS	RC1410A0	BANDE SERRAGE TUYAU D16-27 INOX	6.000	PCS	SN1053A0		1.000	PCS	SN1061A0	D4x175MM NTC PROBE	1.000	PCS	TB3822A0		2.000	PCS	TB4135A0		1.000	PCS	TB4160A0		1.000	PCS	VI1103A0	VIS POUR PLASTIQUE 40X12 TPBS+INOX	9.000	PCS	VI1220A1	VIS AUTOTARADE UX 4.2x12 TCB MARUTEX PRE	2.000	PCS	VI1931A0	ECROU M8x1,65 H4 CH13 ZINGUE	1.000	PCS	VL1178A0	O RING D INTERIEUR 10,8 CORDE 1,78 EPDM	2.000	PCS	VL1315A1	ASM BLOCAGE RESERVOIR POMPE DID	1.000	PCS	VL1318A0	SUPPORT POMPE DE RECIRCULATI ON DID	1.000	PCS	VL1329A0	RACCORD D24-D16	1.000	PCS
Code	Description	Qté	UOM																																																																																										
CN1016A0	CONDENSATE UR 2.5 µF 500V CE/UL	1.000	PCS																																																																																										
GN1400A0	U-TRAP SEAL	1.000	PCS																																																																																										
PM1013A0	240V 32W DRAIN PUMP	1.000	PCS																																																																																										
PM1018A0	POMPE RECYCLAGE 240V 100W	1.000	PCS																																																																																										
RC1019A0	COLLIER ELASTIQUE D10 ZINGUE	2.000	PCS																																																																																										
RC1046A0	COLLIER DE SERRAGE TUBE D10-16 H9 INOX	1.000	PCS																																																																																										
RC1360A0	10 - 10 JG ELBOW FITTIN	2.000	PCS																																																																																										
RC1378A0	PINCE DURITE	1.000	PCS																																																																																										
RC1410A0	BANDE SERRAGE TUYAU D16-27 INOX	6.000	PCS																																																																																										
SN1053A0		1.000	PCS																																																																																										
SN1061A0	D4x175MM NTC PROBE	1.000	PCS																																																																																										
TB3822A0		2.000	PCS																																																																																										
TB4135A0		1.000	PCS																																																																																										
TB4160A0		1.000	PCS																																																																																										
VI1103A0	VIS POUR PLASTIQUE 40X12 TPBS+INOX	9.000	PCS																																																																																										
VI1220A1	VIS AUTOTARADE UX 4.2x12 TCB MARUTEX PRE	2.000	PCS																																																																																										
VI1931A0	ECROU M8x1,65 H4 CH13 ZINGUE	1.000	PCS																																																																																										
VL1178A0	O RING D INTERIEUR 10,8 CORDE 1,78 EPDM	2.000	PCS																																																																																										
VL1315A1	ASM BLOCAGE RESERVOIR POMPE DID	1.000	PCS																																																																																										
VL1318A0	SUPPORT POMPE DE RECIRCULATI ON DID	1.000	PCS																																																																																										
VL1329A0	RACCORD D24-D16	1.000	PCS																																																																																										

COMPOSANT			PIÈCE DE RECHANGE																																						
Code	Description	Image	Code	Description	Composants du kit																																				
VM2039A	ANNEAU FIXAGE COURBE DE DECHARGE		KVL1310A	KIT COMPLET GROUP RESERV RECIRC CBX	<table border="1"> <thead> <tr> <th>Code</th> <th>Description</th> <th>Qté</th> <th>UOM</th> </tr> </thead> <tbody> <tr> <td>VL1332A0</td> <td>BOUCHON RESERVOIR DI</td> <td>1.000</td> <td>PCS</td> </tr> <tr> <td>VL1340A0</td> <td>RACCORD BYPASS M-M JG10 DID</td> <td>1.000</td> <td>PCS</td> </tr> <tr> <td>VL1400A0</td> <td>COUDE ÉVACUATION BORD PARTIE</td> <td>1.000</td> <td>PCS</td> </tr> <tr> <td>VL1407A1</td> <td>ASM REDUCTEUR DID</td> <td>1.000</td> <td>PCS</td> </tr> <tr> <td>VM1794A0</td> <td>PLAQUETTE NOIRE 250X4.8 PA66</td> <td>1.000</td> <td>PCS</td> </tr> <tr> <td>VM1802A0</td> <td>GOUPILLE DE ROTATION PORTE RÉSERVOIR DI</td> <td>1.000</td> <td>PCS</td> </tr> <tr> <td>VM2039A0</td> <td>ANNEAU FIXAGE COURBE DE DECHARGE</td> <td>1.000</td> <td>PCS</td> </tr> <tr> <td>VM2640A0</td> <td>PROTECTION POMPE D'ÉVACUATIO</td> <td>1.000</td> <td>PCS</td> </tr> </tbody> </table>	Code	Description	Qté	UOM	VL1332A0	BOUCHON RESERVOIR DI	1.000	PCS	VL1340A0	RACCORD BYPASS M-M JG10 DID	1.000	PCS	VL1400A0	COUDE ÉVACUATION BORD PARTIE	1.000	PCS	VL1407A1	ASM REDUCTEUR DID	1.000	PCS	VM1794A0	PLAQUETTE NOIRE 250X4.8 PA66	1.000	PCS	VM1802A0	GOUPILLE DE ROTATION PORTE RÉSERVOIR DI	1.000	PCS	VM2039A0	ANNEAU FIXAGE COURBE DE DECHARGE	1.000	PCS	VM2640A0	PROTECTION POMPE D'ÉVACUATIO	1.000	PCS
			Code		Description	Qté	UOM																																		
VL1332A0	BOUCHON RESERVOIR DI	1.000	PCS																																						
VL1340A0	RACCORD BYPASS M-M JG10 DID	1.000	PCS																																						
VL1400A0	COUDE ÉVACUATION BORD PARTIE	1.000	PCS																																						
VL1407A1	ASM REDUCTEUR DID	1.000	PCS																																						
VM1794A0	PLAQUETTE NOIRE 250X4.8 PA66	1.000	PCS																																						
VM1802A0	GOUPILLE DE ROTATION PORTE RÉSERVOIR DI	1.000	PCS																																						
VM2039A0	ANNEAU FIXAGE COURBE DE DECHARGE	1.000	PCS																																						
VM2640A0	PROTECTION POMPE D'ÉVACUATIO	1.000	PCS																																						
KVL1026A	KIT COURBE POUR TUYAU DECHARGE	<table border="1"> <thead> <tr> <th>Code</th> <th>Description</th> <th>Qté</th> <th>UOM</th> </tr> </thead> <tbody> <tr> <td>GN1400A0</td> <td>U-TRAP SEAL</td> <td>1.000</td> <td>PCS</td> </tr> <tr> <td>VL1026A0</td> <td>COURBE POUR TUYAU DECHARGE</td> <td>1.000</td> <td>PCS</td> </tr> <tr> <td>VM2039A0</td> <td>ANNEAU FIXAGE COURBE DE DECHARGE</td> <td>1.000</td> <td>PCS</td> </tr> </tbody> </table>	Code	Description	Qté	UOM	GN1400A0	U-TRAP SEAL	1.000	PCS	VL1026A0	COURBE POUR TUYAU DECHARGE	1.000	PCS	VM2039A0	ANNEAU FIXAGE COURBE DE DECHARGE	1.000	PCS																							
Code	Description	Qté	UOM																																						
GN1400A0	U-TRAP SEAL	1.000	PCS																																						
VL1026A0	COURBE POUR TUYAU DECHARGE	1.000	PCS																																						
VM2039A0	ANNEAU FIXAGE COURBE DE DECHARGE	1.000	PCS																																						
VM1555A	SUPPORT TURBINE REFROIDISS. CT BT		KVN1165A	KIT VENTIL. REFR. 230V S.5E ADV/MM	<table border="1"> <thead> <tr> <th>Code</th> <th>Description</th> <th>Qté</th> <th>UOM</th> </tr> </thead> <tbody> <tr> <td>V11099A0</td> <td>VIS AUTOPERCEU SE 4.8X13 TCB+ZN</td> <td>4.000</td> <td>PCS</td> </tr> <tr> <td>VM1555A2</td> <td>SUPPORT TURBINE REFROIDISS. CT BT</td> <td>1.000</td> <td>PCS</td> </tr> <tr> <td>VN1165A0</td> <td>TURBINE DE REFROIDISSE MENT 230Vac 50/60H</td> <td>1.000</td> <td>PCS</td> </tr> </tbody> </table>	Code	Description	Qté	UOM	V11099A0	VIS AUTOPERCEU SE 4.8X13 TCB+ZN	4.000	PCS	VM1555A2	SUPPORT TURBINE REFROIDISS. CT BT	1.000	PCS	VN1165A0	TURBINE DE REFROIDISSE MENT 230Vac 50/60H	1.000	PCS																				
Code	Description	Qté	UOM																																						
V11099A0	VIS AUTOPERCEU SE 4.8X13 TCB+ZN	4.000	PCS																																						
VM1555A2	SUPPORT TURBINE REFROIDISS. CT BT	1.000	PCS																																						
VN1165A0	TURBINE DE REFROIDISSE MENT 230Vac 50/60H	1.000	PCS																																						





COMPOSANT			PIÈCE DE RECHANGE																		
Code	Description	Image	Code	Description	Composants du kit																
VM1555A	SUPPORT TURBINE REFROIDISS. CT BT		KVN1164A	KIT TURBINE REFROIDISSEMENT 12VDC S.5/5E	<table border="1"> <thead> <tr> <th>Code</th> <th>Description</th> <th>Qté</th> <th>UOM</th> </tr> </thead> <tbody> <tr> <td>VI1099A0</td> <td>VIS AUTOPERCEU SE 4.8X13 TCB+ZN</td> <td>4.000</td> <td>PCS</td> </tr> <tr> <td>VM1555A2</td> <td>SUPPORT TURBINE REFROIDISS. CT BT</td> <td>1.000</td> <td>PCS</td> </tr> <tr> <td>VN1164A0</td> <td>TURBINE REFROIDISSE MENT 12VDC</td> <td>1.000</td> <td>PCS</td> </tr> </tbody> </table>	Code	Description	Qté	UOM	VI1099A0	VIS AUTOPERCEU SE 4.8X13 TCB+ZN	4.000	PCS	VM1555A2	SUPPORT TURBINE REFROIDISS. CT BT	1.000	PCS	VN1164A0	TURBINE REFROIDISSE MENT 12VDC	1.000	PCS
Code	Description	Qté	UOM																		
VI1099A0	VIS AUTOPERCEU SE 4.8X13 TCB+ZN	4.000	PCS																		
VM1555A2	SUPPORT TURBINE REFROIDISS. CT BT	1.000	PCS																		
VN1164A0	TURBINE REFROIDISSE MENT 12VDC	1.000	PCS																		
VM1556A	PROTECTION TURBINE DE REFROIDISSEMENT		KVM1556A	KIT DE PROTECTION TURBINE DE REFROIDISS	<table border="1"> <thead> <tr> <th>Code</th> <th>Description</th> <th>Qté</th> <th>UOM</th> </tr> </thead> <tbody> <tr> <td>VM1556A0</td> <td>PROTECTION TURBINE DE REFROIDISSE MENT</td> <td>1.000</td> <td>PCS</td> </tr> </tbody> </table>	Code	Description	Qté	UOM	VM1556A0	PROTECTION TURBINE DE REFROIDISSE MENT	1.000	PCS								
Code	Description	Qté	UOM																		
VM1556A0	PROTECTION TURBINE DE REFROIDISSE MENT	1.000	PCS																		
VN1165A	TURBINE DE REFROIDISSEMENT 230Vac 50/60H		KVN1165A	KIT VENTIL. REFR. 230V S.5E ADV/MM	<table border="1"> <thead> <tr> <th>Code</th> <th>Description</th> <th>Qté</th> <th>UOM</th> </tr> </thead> <tbody> <tr> <td>VI1099A0</td> <td>VIS AUTOPERCEU SE 4.8X13 TCB+ZN</td> <td>4.000</td> <td>PCS</td> </tr> <tr> <td>VM1555A2</td> <td>SUPPORT TURBINE REFROIDISS. CT BT</td> <td>1.000</td> <td>PCS</td> </tr> <tr> <td>VN1165A0</td> <td>TURBINE DE REFROIDISSE MENT 230Vac 50/60H</td> <td>1.000</td> <td>PCS</td> </tr> </tbody> </table>	Code	Description	Qté	UOM	VI1099A0	VIS AUTOPERCEU SE 4.8X13 TCB+ZN	4.000	PCS	VM1555A2	SUPPORT TURBINE REFROIDISS. CT BT	1.000	PCS	VN1165A0	TURBINE DE REFROIDISSE MENT 230Vac 50/60H	1.000	PCS
Code	Description	Qté	UOM																		
VI1099A0	VIS AUTOPERCEU SE 4.8X13 TCB+ZN	4.000	PCS																		
VM1555A2	SUPPORT TURBINE REFROIDISS. CT BT	1.000	PCS																		
VN1165A0	TURBINE DE REFROIDISSE MENT 230Vac 50/60H	1.000	PCS																		
0H2561A	CONTRE ETRIER PORTE MM		0H2561A0	CONTRE ETRIER PORTE MM																	

COMPOSANT			PIÈCE DE RECHANGE																										
Code	Description	Image	Code	Description	Composants du kit																								
VI1995A	VIS M5x25 TCEI INO		VI1995A0	VIS M5x25 TCEI INO																									
VM1240A	BOUCHON NYLON SUPPORTCONTRE- BRIDE		KVM1240A	KIT BOUCHON SUPPORT CONTRE-BRIDE 4 PCS	<table border="1"> <thead> <tr> <th>Code</th> <th>Description</th> <th>Qté</th> <th>UOM</th> </tr> </thead> <tbody> <tr> <td>VM1240A0</td> <td>BOUCHON NYLON SUPPORTCON TRE-BRIDE</td> <td>4.000</td> <td>PCS</td> </tr> </tbody> </table>	Code	Description	Qté	UOM	VM1240A0	BOUCHON NYLON SUPPORTCON TRE-BRIDE	4.000	PCS																
Code	Description	Qté	UOM																										
VM1240A0	BOUCHON NYLON SUPPORTCON TRE-BRIDE	4.000	PCS																										
VM2273A	MM DOOR LEFT LOWER BRACKET		KVM2273A	KIT SUPPORT INF PORTE MIND.Maps GAUCHE	<table border="1"> <thead> <tr> <th>Code</th> <th>Description</th> <th>Qté</th> <th>UOM</th> </tr> </thead> <tbody> <tr> <td>0H7330A0</td> <td>RONDELLE ETRIER INFERIEUR PORTE MM</td> <td>2.000</td> <td>PCS</td> </tr> <tr> <td>VI1995A0</td> <td>VIS M5x25 TCEI INOX</td> <td>4.000</td> <td>PCS</td> </tr> <tr> <td>VM2273A1</td> <td>MM DOOR LEFT LOWER BRACKET</td> <td>1.000</td> <td>PCS</td> </tr> <tr> <td>VM2352A0</td> <td>CAPUCHON G COUVREVIS ETRIER PORTE INF M</td> <td>1.000</td> <td>PCS</td> </tr> <tr> <td>VM2353A0</td> <td>CAPUCHON COUVRE VIS ETRIER PORTE INF M</td> <td>1.000</td> <td>PCS</td> </tr> </tbody> </table>	Code	Description	Qté	UOM	0H7330A0	RONDELLE ETRIER INFERIEUR PORTE MM	2.000	PCS	VI1995A0	VIS M5x25 TCEI INOX	4.000	PCS	VM2273A1	MM DOOR LEFT LOWER BRACKET	1.000	PCS	VM2352A0	CAPUCHON G COUVREVIS ETRIER PORTE INF M	1.000	PCS	VM2353A0	CAPUCHON COUVRE VIS ETRIER PORTE INF M	1.000	PCS
Code	Description	Qté	UOM																										
0H7330A0	RONDELLE ETRIER INFERIEUR PORTE MM	2.000	PCS																										
VI1995A0	VIS M5x25 TCEI INOX	4.000	PCS																										
VM2273A1	MM DOOR LEFT LOWER BRACKET	1.000	PCS																										
VM2352A0	CAPUCHON G COUVREVIS ETRIER PORTE INF M	1.000	PCS																										
VM2353A0	CAPUCHON COUVRE VIS ETRIER PORTE INF M	1.000	PCS																										
VM2352A	CAPUCHON G COUVREVIS ETRIER PORTE INF MM		VM2352A0	CAPUCHON G COUVREVIS ETRIER PORTE INF MM																									

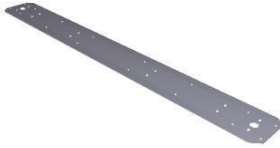

COMPOSANT			PIÈCE DE RECHANGE																										
Code	Description	Image	Code	Description	Composants du kit																								
VM2353A	CAPUCHON COUVRE VIS ETRIER PORTE INF MM		VM2353A0	CAPUCHON COUVRE VIS ETRIER PORTE INF MM																									
0H2561A	CONTRE ETRIER PORTE MM		0H2561A0	CONTRE ETRIER PORTE MM																									
VI1995A	VIS M5x25 TCEI INO		VI1995A0	VIS M5x25 TCEI INO																									
VM1240A	BOUCHON NYLON SUPPORTCONTRE- BRIDE		KVM1240A	KIT BOUCHON SUPPORT CONTRE-BRIDE 4 PCS	<table border="1"> <thead> <tr> <th>Code</th> <th>Description</th> <th>Qté</th> <th>UOM</th> </tr> </thead> <tbody> <tr> <td>VM1240A0</td> <td>BOUCHON NYLON SUPPORTCON TRE-BRIDE</td> <td>4.000</td> <td>PCS</td> </tr> </tbody> </table>	Code	Description	Qté	UOM	VM1240A0	BOUCHON NYLON SUPPORTCON TRE-BRIDE	4.000	PCS																
Code	Description	Qté	UOM																										
VM1240A0	BOUCHON NYLON SUPPORTCON TRE-BRIDE	4.000	PCS																										
VM2271A	SUPPORT SUPERIEUR PORTE MM GAUCHE		KVM2271A	KIT ETRIER SUPER PORTE MIND.MAPS GAUCHE	<table border="1"> <thead> <tr> <th>Code</th> <th>Description</th> <th>Qté</th> <th>UOM</th> </tr> </thead> <tbody> <tr> <td>VI1220A1</td> <td>VIS AUTOTARADE UX 4.2x12 TCB MARUTEX PRE</td> <td>2.000</td> <td>PCS</td> </tr> <tr> <td>VI1995A0</td> <td>VIS M5x25 TCEI INOX</td> <td>4.000</td> <td>PCS</td> </tr> <tr> <td>VI1997A0</td> <td>5x10X1 FLAT WASHER</td> <td>4.000</td> <td>PCS</td> </tr> <tr> <td>VM2271A0</td> <td>SUPPORT SUPERIEUR PORTE MM GAUCHE</td> <td>1.000</td> <td>PCS</td> </tr> <tr> <td>VM2298A0</td> <td>COUVERCLE SUPER SUPPORT PORTE MM</td> <td>1.000</td> <td>PCS</td> </tr> </tbody> </table>	Code	Description	Qté	UOM	VI1220A1	VIS AUTOTARADE UX 4.2x12 TCB MARUTEX PRE	2.000	PCS	VI1995A0	VIS M5x25 TCEI INOX	4.000	PCS	VI1997A0	5x10X1 FLAT WASHER	4.000	PCS	VM2271A0	SUPPORT SUPERIEUR PORTE MM GAUCHE	1.000	PCS	VM2298A0	COUVERCLE SUPER SUPPORT PORTE MM	1.000	PCS
Code	Description	Qté	UOM																										
VI1220A1	VIS AUTOTARADE UX 4.2x12 TCB MARUTEX PRE	2.000	PCS																										
VI1995A0	VIS M5x25 TCEI INOX	4.000	PCS																										
VI1997A0	5x10X1 FLAT WASHER	4.000	PCS																										
VM2271A0	SUPPORT SUPERIEUR PORTE MM GAUCHE	1.000	PCS																										
VM2298A0	COUVERCLE SUPER SUPPORT PORTE MM	1.000	PCS																										

COMPOSANT			PIÈCE DE RECHANGE																																						
Code	Description	Image	Code	Description	Composants du kit																																				
VM2298A	COUVERCLE SUPER SUPPORT PORTE M		KVM2298A	KIT COUVERCLE SUPPORT DE FIXATION SUP. P	<table border="1"> <thead> <tr> <th>Code</th> <th>Description</th> <th>Qté</th> <th>UOM</th> </tr> </thead> <tbody> <tr> <td>VI1220A1</td> <td>VIS AUTOTARADE UX 4.2x12 TCB MARUTEX PRE</td> <td>2.000</td> <td>PCS</td> </tr> <tr> <td>VM2298A0</td> <td>COUVERCLE SUPER SUPPORT PORTE MM</td> <td>1.000</td> <td>PCS</td> </tr> </tbody> </table>	Code	Description	Qté	UOM	VI1220A1	VIS AUTOTARADE UX 4.2x12 TCB MARUTEX PRE	2.000	PCS	VM2298A0	COUVERCLE SUPER SUPPORT PORTE MM	1.000	PCS																								
Code	Description	Qté	UOM																																						
VI1220A1	VIS AUTOTARADE UX 4.2x12 TCB MARUTEX PRE	2.000	PCS																																						
VM2298A0	COUVERCLE SUPER SUPPORT PORTE MM	1.000	PCS																																						
0H2561A	CONTRE ETRIER PORTE MM		0H2561A0	CONTRE ETRIER PORTE MM																																					
VE1020B	CONTACT DE PORTE MAGNETIQUE AVEC MINIFIT		KVE1020B	KIT MICROPORTE	<table border="1"> <thead> <tr> <th>Code</th> <th>Description</th> <th>Qté</th> <th>UOM</th> </tr> </thead> <tbody> <tr> <td>CE1030A0</td> <td>FASTON FEMELLE 6.3X0.8 0.5-1 MMQ</td> <td>2.000</td> <td>PCS</td> </tr> <tr> <td>CE1660A0</td> <td>COUVERTURE FASTON FEMELLE 6.3X0.8</td> <td>2.000</td> <td>PCS</td> </tr> <tr> <td>CE1730A0</td> <td>CABLE PVC NP 0.150 X AWG22 STYLE 2095</td> <td>0.150</td> <td>M</td> </tr> <tr> <td>CE1740A0</td> <td>BORNE MINIFIT MALE</td> <td>2.000</td> <td>PCS</td> </tr> <tr> <td>CE1745A0</td> <td>CONNECTEUR MINIFIT FEMELLE 2 VOIES</td> <td>1.000</td> <td>PCS</td> </tr> <tr> <td>VE1020B0</td> <td>CONTACT DE PORTE MAGNETIQUE AVEC MINIFIT</td> <td>1.000</td> <td>PCS</td> </tr> <tr> <td>VE1030A1</td> <td>AIMANT D=22.9mm POUR MICROPORTE</td> <td>1.000</td> <td>PCS</td> </tr> <tr> <td>VI1192A0</td> <td>BOULON M10X0.75 H3 LAITON NICKELE</td> <td>1.000</td> <td>PCS</td> </tr> </tbody> </table>	Code	Description	Qté	UOM	CE1030A0	FASTON FEMELLE 6.3X0.8 0.5-1 MMQ	2.000	PCS	CE1660A0	COUVERTURE FASTON FEMELLE 6.3X0.8	2.000	PCS	CE1730A0	CABLE PVC NP 0.150 X AWG22 STYLE 2095	0.150	M	CE1740A0	BORNE MINIFIT MALE	2.000	PCS	CE1745A0	CONNECTEUR MINIFIT FEMELLE 2 VOIES	1.000	PCS	VE1020B0	CONTACT DE PORTE MAGNETIQUE AVEC MINIFIT	1.000	PCS	VE1030A1	AIMANT D=22.9mm POUR MICROPORTE	1.000	PCS	VI1192A0	BOULON M10X0.75 H3 LAITON NICKELE	1.000	PCS
Code	Description	Qté	UOM																																						
CE1030A0	FASTON FEMELLE 6.3X0.8 0.5-1 MMQ	2.000	PCS																																						
CE1660A0	COUVERTURE FASTON FEMELLE 6.3X0.8	2.000	PCS																																						
CE1730A0	CABLE PVC NP 0.150 X AWG22 STYLE 2095	0.150	M																																						
CE1740A0	BORNE MINIFIT MALE	2.000	PCS																																						
CE1745A0	CONNECTEUR MINIFIT FEMELLE 2 VOIES	1.000	PCS																																						
VE1020B0	CONTACT DE PORTE MAGNETIQUE AVEC MINIFIT	1.000	PCS																																						
VE1030A1	AIMANT D=22.9mm POUR MICROPORTE	1.000	PCS																																						
VI1192A0	BOULON M10X0.75 H3 LAITON NICKELE	1.000	PCS																																						

COMPOSANT			PIÈCE DE RECHANGE										
Code	Description	Image	Code	Description	Composants du kit								
VM1240A	BOUCHON NYLON SUPPORTCONTRE- BRIDE		KVM1240A	KIT BOUCHON SUPPORT CONTRE-BRIDE 4 PCS	<table border="1"> <thead> <tr> <th>Code</th> <th>Description</th> <th>Qté</th> <th>UOM</th> </tr> </thead> <tbody> <tr> <td>VM1240A0</td> <td>BOUCHON NYLON SUPPORTCON TRE-BRIDE</td> <td>4.000</td> <td>PCS</td> </tr> </tbody> </table>	Code	Description	Qté	UOM	VM1240A0	BOUCHON NYLON SUPPORTCON TRE-BRIDE	4.000	PCS
Code	Description	Qté	UOM										
VM1240A0	BOUCHON NYLON SUPPORTCON TRE-BRIDE	4.000	PCS										
VM2282A	MICROSWITCH SUPPORT COVER		KVM2282A	KIT PLAQUE SUPPORT MICROPORTE	<table border="1"> <thead> <tr> <th>Code</th> <th>Description</th> <th>Qté</th> <th>UOM</th> </tr> </thead> <tbody> <tr> <td>VM2282A0</td> <td>MICROSWITC H SUPPORT COVER</td> <td>1.000</td> <td>PCS</td> </tr> </tbody> </table>	Code	Description	Qté	UOM	VM2282A0	MICROSWITC H SUPPORT COVER	1.000	PCS
Code	Description	Qté	UOM										
VM2282A0	MICROSWITC H SUPPORT COVER	1.000	PCS										
0H2561A	CONTRE ETRIER PORTE MM		0H2561A0	CONTRE ETRIER PORTE MM									
VM1240A	BOUCHON NYLON SUPPORTCONTRE- BRIDE		KVM1240A	KIT BOUCHON SUPPORT CONTRE-BRIDE 4 PCS	<table border="1"> <thead> <tr> <th>Code</th> <th>Description</th> <th>Qté</th> <th>UOM</th> </tr> </thead> <tbody> <tr> <td>VM1240A0</td> <td>BOUCHON NYLON SUPPORTCON TRE-BRIDE</td> <td>4.000</td> <td>PCS</td> </tr> </tbody> </table>	Code	Description	Qté	UOM	VM1240A0	BOUCHON NYLON SUPPORTCON TRE-BRIDE	4.000	PCS
Code	Description	Qté	UOM										
VM1240A0	BOUCHON NYLON SUPPORTCON TRE-BRIDE	4.000	PCS										
VM2310A	PLAQUE L COUVRE TROUS SUPPORT SUP		KVM2310A	KIT PLAQUETTE AL COUVRE-TROUS ETRIER SUP	<table border="1"> <thead> <tr> <th>Code</th> <th>Description</th> <th>Qté</th> <th>UOM</th> </tr> </thead> <tbody> <tr> <td>VM2310A0</td> <td>PLAQUE L COUVRE TROUS SUPPORT SUP</td> <td>1.000</td> <td>PCS</td> </tr> </tbody> </table>	Code	Description	Qté	UOM	VM2310A0	PLAQUE L COUVRE TROUS SUPPORT SUP	1.000	PCS
Code	Description	Qté	UOM										
VM2310A0	PLAQUE L COUVRE TROUS SUPPORT SUP	1.000	PCS										

COMPOSANT			PIÈCE DE RECHANGE																		
Code	Description	Image	Code	Description	Composants du kit																
0H1019A	TOLE RENFORCEMENT PIEDS H100 CT		K0H1019A	KIT RENFORCEMENT TOLE POUR PIEDS H100 CT	<table border="1"> <thead> <tr> <th>Code</th> <th>Description</th> <th>Qté</th> <th>UOM</th> </tr> </thead> <tbody> <tr> <td>0H1019A2</td> <td>TOLE RENFORCEME NT PIEDS H100 CT</td> <td>1.000</td> <td>PCS</td> </tr> <tr> <td>V11739A0</td> <td>ZINC THREAD INSERT M10 FTT/E STP</td> <td>2.000</td> <td>PCS</td> </tr> </tbody> </table>	Code	Description	Qté	UOM	0H1019A2	TOLE RENFORCEME NT PIEDS H100 CT	1.000	PCS	V11739A0	ZINC THREAD INSERT M10 FTT/E STP	2.000	PCS				
					Code	Description	Qté	UOM													
0H1019A2	TOLE RENFORCEME NT PIEDS H100 CT	1.000	PCS																		
V11739A0	ZINC THREAD INSERT M10 FTT/E STP	2.000	PCS																		
<table border="1"> <thead> <tr> <th>Code</th> <th>Description</th> <th>Qté</th> <th>UOM</th> </tr> </thead> <tbody> <tr> <td>PD1074A0</td> <td>PIED H100 BICOMPOSAN T CARRÉ</td> <td>1.000</td> <td>PCS</td> </tr> <tr> <td>PD1075A1</td> <td>BRIDE BLOCAGE PIED PD1074</td> <td>1.000</td> <td>PCS</td> </tr> <tr> <td>V11220A1</td> <td>VIS AUTOTARADE UX 4.2x12 TCB MARUTEX PRE</td> <td>5.000</td> <td>PCS</td> </tr> </tbody> </table>	Code	Description	Qté	UOM	PD1074A0	PIED H100 BICOMPOSAN T CARRÉ	1.000	PCS	PD1075A1	BRIDE BLOCAGE PIED PD1074	1.000	PCS	V11220A1	VIS AUTOTARADE UX 4.2x12 TCB MARUTEX PRE	5.000	PCS					
Code	Description	Qté	UOM																		
PD1074A0	PIED H100 BICOMPOSAN T CARRÉ	1.000	PCS																		
PD1075A1	BRIDE BLOCAGE PIED PD1074	1.000	PCS																		
V11220A1	VIS AUTOTARADE UX 4.2x12 TCB MARUTEX PRE	5.000	PCS																		
PD1074A	PIED H100 BICOMPOSANT CARRÉ		KPD1074A	KIT PIED H100 PD1074A0	<table border="1"> <thead> <tr> <th>Code</th> <th>Description</th> <th>Qté</th> <th>UOM</th> </tr> </thead> <tbody> <tr> <td>PD1074A0</td> <td>PIED H100 BICOMPOSAN T CARRÉ</td> <td>1.000</td> <td>PCS</td> </tr> <tr> <td>PD1075A1</td> <td>BRIDE BLOCAGE PIED PD1074</td> <td>1.000</td> <td>PCS</td> </tr> <tr> <td>V11220A1</td> <td>VIS AUTOTARADE UX 4.2x12 TCB MARUTEX PRE</td> <td>5.000</td> <td>PCS</td> </tr> </tbody> </table>	Code	Description	Qté	UOM	PD1074A0	PIED H100 BICOMPOSAN T CARRÉ	1.000	PCS	PD1075A1	BRIDE BLOCAGE PIED PD1074	1.000	PCS	V11220A1	VIS AUTOTARADE UX 4.2x12 TCB MARUTEX PRE	5.000	PCS
Code	Description	Qté	UOM																		
PD1074A0	PIED H100 BICOMPOSAN T CARRÉ	1.000	PCS																		
PD1075A1	BRIDE BLOCAGE PIED PD1074	1.000	PCS																		
V11220A1	VIS AUTOTARADE UX 4.2x12 TCB MARUTEX PRE	5.000	PCS																		
PD1075A	BRIDE BLOCAGE PIED PD1074		KPD1075A	KIT ETRIER BLOCAGE PIED PD1074A0 4 PCS	<table border="1"> <thead> <tr> <th>Code</th> <th>Description</th> <th>Qté</th> <th>UOM</th> </tr> </thead> <tbody> <tr> <td>PD1075A1</td> <td>BRIDE BLOCAGE PIED PD1074</td> <td>4.000</td> <td>PCS</td> </tr> <tr> <td>V11950A0</td> <td>VIS AUTOPERCEU SE 4.2X13 TCB INOX</td> <td>8.000</td> <td>PCS</td> </tr> </tbody> </table>	Code	Description	Qté	UOM	PD1075A1	BRIDE BLOCAGE PIED PD1074	4.000	PCS	V11950A0	VIS AUTOPERCEU SE 4.2X13 TCB INOX	8.000	PCS				
Code	Description	Qté	UOM																		
PD1075A1	BRIDE BLOCAGE PIED PD1074	4.000	PCS																		
V11950A0	VIS AUTOPERCEU SE 4.2X13 TCB INOX	8.000	PCS																		
EL1430B	ELECTROVANNE VAP. 5+21 BARBED		KEL1430B	KIT ELECTROVANNE DOUBLE 5+21 BARBED 6	<table border="1"> <thead> <tr> <th>Code</th> <th>Description</th> <th>Qté</th> <th>UOM</th> </tr> </thead> <tbody> <tr> <td>EL1430B0</td> <td>ELECTROVAN NE VAP. 5+21 BARBED</td> <td>1.000</td> <td>PCS</td> </tr> <tr> <td>RC1414A1</td> <td>COLLIER A COMPRESSIO N D11.5-12.5</td> <td>2.000</td> <td>PCS</td> </tr> </tbody> </table>	Code	Description	Qté	UOM	EL1430B0	ELECTROVAN NE VAP. 5+21 BARBED	1.000	PCS	RC1414A1	COLLIER A COMPRESSIO N D11.5-12.5	2.000	PCS				
Code	Description	Qté	UOM																		
EL1430B0	ELECTROVAN NE VAP. 5+21 BARBED	1.000	PCS																		
RC1414A1	COLLIER A COMPRESSIO N D11.5-12.5	2.000	PCS																		
VL1101B	VL1101B0		KVL1183A	KIT SYSTEME LAVAGE PLUS 1 BRAS	<table border="1"> <thead> <tr> <th>Code</th> <th>Description</th> <th>Qté</th> <th>UOM</th> </tr> </thead> <tbody> <tr> <td>0H2354A1</td> <td>TOLE SYSTEME LAVAGE PLUS XEVC-XEVL</td> <td>1.000</td> <td>PCS</td> </tr> <tr> <td>EL1440A0</td> <td>ELECTROVAN NE H2O AUTONETTOY ANTE BAIONNET</td> <td>3.000</td> <td>PCS</td> </tr> <tr> <td>GN1526A0</td> <td>O-RING D.INT6.9 SP1.8</td> <td>7.000</td> <td>PCS</td> </tr> </tbody> </table>	Code	Description	Qté	UOM	0H2354A1	TOLE SYSTEME LAVAGE PLUS XEVC-XEVL	1.000	PCS	EL1440A0	ELECTROVAN NE H2O AUTONETTOY ANTE BAIONNET	3.000	PCS	GN1526A0	O-RING D.INT6.9 SP1.8	7.000	PCS
Code	Description	Qté	UOM																		
0H2354A1	TOLE SYSTEME LAVAGE PLUS XEVC-XEVL	1.000	PCS																		
EL1440A0	ELECTROVAN NE H2O AUTONETTOY ANTE BAIONNET	3.000	PCS																		
GN1526A0	O-RING D.INT6.9 SP1.8	7.000	PCS																		

COMPOSANT			PIÈCE DE RECHANGE																																																																																		
Code	Description	Image	Code	Description	Composants du kit																																																																																
VL1101B	VL1101B0		KVL1183A	KIT SYSTEME LAVAGE PLUS 1 BRAS	<table border="1"> <thead> <tr> <th>Code</th> <th>Description</th> <th>Qté</th> <th>UOM</th> </tr> </thead> <tbody> <tr> <td>RC1018A0</td> <td>COLLIER ELASTIQUE D12 ZINGUE</td> <td>1.000</td> <td>PCS</td> </tr> <tr> <td>RC1019A0</td> <td>COLLIER ELASTIQUE D10 ZINGUE</td> <td>12.000</td> <td>PCS</td> </tr> <tr> <td>RC1130A0</td> <td>COLLIER 130X2.6</td> <td>1.000</td> <td>PCS</td> </tr> <tr> <td>RC1131A0</td> <td>COLLIER 200X2.6 NOIR</td> <td>2.000</td> <td>PCS</td> </tr> <tr> <td>RC1242A0</td> <td>EXTREMITÉ FERME</td> <td>2.000</td> <td>PCS</td> </tr> <tr> <td>RC1356A0</td> <td>RACCORD DROIT FIL FEMELLE 8X1/4 BSP</td> <td>1.000</td> <td>PCS</td> </tr> <tr> <td>RC1414A1</td> <td>COLLIER A COMPRESSIO N D11.5-12.5</td> <td>1.000</td> <td>PCS</td> </tr> <tr> <td>TB2821A0</td> <td>TB2820A-L=40 MM EPDM NOI</td> <td>4.000</td> <td>PCS</td> </tr> <tr> <td>TB3004A0</td> <td>TB2820A L=550mm EPDM BLACK PIPE</td> <td>1.000</td> <td>PCS</td> </tr> <tr> <td>TB3005B0</td> <td>TB3132A L=550mm EPDM WHITE-BLUE PIPE</td> <td>1.000</td> <td>PCS</td> </tr> <tr> <td>TB3225B0</td> <td>TB2820A-L=67 0MM EPDM NOIR</td> <td>1.000</td> <td>PCS</td> </tr> <tr> <td>TB3252A0</td> <td>TB3252A0</td> <td>1.000</td> <td>PCS</td> </tr> <tr> <td>TB3614A0</td> <td>TB3614A0</td> <td>1.000</td> <td>PCS</td> </tr> <tr> <td>VI1220A1</td> <td>VIS AUTOTARADE UX 4.2x12 TCB MARUTEX PRE</td> <td>1.000</td> <td>PCS</td> </tr> <tr> <td>VL1019A0</td> <td>POMPE DETERGENT VIBRATION</td> <td>1.000</td> <td>PCS</td> </tr> <tr> <td>VL1047A1</td> <td>PORTEGOMME D6-EXTREMITÉ D8</td> <td>1.000</td> <td>PCS</td> </tr> <tr> <td>VL1065A1</td> <td>PRESSOSTAT N.O. 1/4 M CIL</td> <td>1.000</td> <td>PCS</td> </tr> <tr> <td>VL1102A1</td> <td>FILTRE DANS LA LIGNE DET+VNR BARBED 6MM</td> <td>1.000</td> <td>PCS</td> </tr> <tr> <td>VL1128A1</td> <td>CLAPET ANTIRETOUR BARBED D6</td> <td>1.000</td> <td>PCS</td> </tr> </tbody> </table>	Code	Description	Qté	UOM	RC1018A0	COLLIER ELASTIQUE D12 ZINGUE	1.000	PCS	RC1019A0	COLLIER ELASTIQUE D10 ZINGUE	12.000	PCS	RC1130A0	COLLIER 130X2.6	1.000	PCS	RC1131A0	COLLIER 200X2.6 NOIR	2.000	PCS	RC1242A0	EXTREMITÉ FERME	2.000	PCS	RC1356A0	RACCORD DROIT FIL FEMELLE 8X1/4 BSP	1.000	PCS	RC1414A1	COLLIER A COMPRESSIO N D11.5-12.5	1.000	PCS	TB2821A0	TB2820A-L=40 MM EPDM NOI	4.000	PCS	TB3004A0	TB2820A L=550mm EPDM BLACK PIPE	1.000	PCS	TB3005B0	TB3132A L=550mm EPDM WHITE-BLUE PIPE	1.000	PCS	TB3225B0	TB2820A-L=67 0MM EPDM NOIR	1.000	PCS	TB3252A0	TB3252A0	1.000	PCS	TB3614A0	TB3614A0	1.000	PCS	VI1220A1	VIS AUTOTARADE UX 4.2x12 TCB MARUTEX PRE	1.000	PCS	VL1019A0	POMPE DETERGENT VIBRATION	1.000	PCS	VL1047A1	PORTEGOMME D6-EXTREMITÉ D8	1.000	PCS	VL1065A1	PRESSOSTAT N.O. 1/4 M CIL	1.000	PCS	VL1102A1	FILTRE DANS LA LIGNE DET+VNR BARBED 6MM	1.000	PCS	VL1128A1	CLAPET ANTIRETOUR BARBED D6	1.000	PCS
Code	Description	Qté	UOM																																																																																		
RC1018A0	COLLIER ELASTIQUE D12 ZINGUE	1.000	PCS																																																																																		
RC1019A0	COLLIER ELASTIQUE D10 ZINGUE	12.000	PCS																																																																																		
RC1130A0	COLLIER 130X2.6	1.000	PCS																																																																																		
RC1131A0	COLLIER 200X2.6 NOIR	2.000	PCS																																																																																		
RC1242A0	EXTREMITÉ FERME	2.000	PCS																																																																																		
RC1356A0	RACCORD DROIT FIL FEMELLE 8X1/4 BSP	1.000	PCS																																																																																		
RC1414A1	COLLIER A COMPRESSIO N D11.5-12.5	1.000	PCS																																																																																		
TB2821A0	TB2820A-L=40 MM EPDM NOI	4.000	PCS																																																																																		
TB3004A0	TB2820A L=550mm EPDM BLACK PIPE	1.000	PCS																																																																																		
TB3005B0	TB3132A L=550mm EPDM WHITE-BLUE PIPE	1.000	PCS																																																																																		
TB3225B0	TB2820A-L=67 0MM EPDM NOIR	1.000	PCS																																																																																		
TB3252A0	TB3252A0	1.000	PCS																																																																																		
TB3614A0	TB3614A0	1.000	PCS																																																																																		
VI1220A1	VIS AUTOTARADE UX 4.2x12 TCB MARUTEX PRE	1.000	PCS																																																																																		
VL1019A0	POMPE DETERGENT VIBRATION	1.000	PCS																																																																																		
VL1047A1	PORTEGOMME D6-EXTREMITÉ D8	1.000	PCS																																																																																		
VL1065A1	PRESSOSTAT N.O. 1/4 M CIL	1.000	PCS																																																																																		
VL1102A1	FILTRE DANS LA LIGNE DET+VNR BARBED 6MM	1.000	PCS																																																																																		
VL1128A1	CLAPET ANTIRETOUR BARBED D6	1.000	PCS																																																																																		

COMPOSANT			PIÈCE DE RECHANGE																																																						
Code	Description	Image	Code	Description	Composants du kit																																																				
VL1101B	VL1101B0		KVL1183A	KIT SYSTEME LAVAGE PLUS 1 BRAS	<table border="1"> <thead> <tr> <th>Code</th> <th>Description</th> <th>Qté</th> <th>UOM</th> </tr> </thead> <tbody> <tr> <td>VL1166A0</td> <td>RACCORD EN L BB6-AL6</td> <td>3.000</td> <td>PCS</td> </tr> <tr> <td>VL1174C0</td> <td>INJECTEUR ETALLONE D 1.2 MM</td> <td>1.000</td> <td>PCS</td> </tr> <tr> <td>VL1185A0</td> <td>DISTRIBUTEU R LAVAGE PLUS 2 VOIES PLUS</td> <td>1.000</td> <td>PCS</td> </tr> <tr> <td>VL1190A0</td> <td>DISTRIBUTEU R ENTREE LAVAGE PLUS</td> <td>1.000</td> <td>PCS</td> </tr> <tr> <td>VL1214A0</td> <td>CLAPET ANTI RETOUR BB6 BAIONETTE</td> <td>1.000</td> <td>PCS</td> </tr> <tr> <td>VM1605A0</td> <td>CLIP TWIST LOCK DIAM. 10,2-12,7 MM</td> <td>3.000</td> <td>PCS</td> </tr> <tr> <td>VM2172A0</td> <td>CLIP BLOCAGE POMPE AVEC CIRCUIT</td> <td>4.000</td> <td>PCS</td> </tr> </tbody> </table>	Code	Description	Qté	UOM	VL1166A0	RACCORD EN L BB6-AL6	3.000	PCS	VL1174C0	INJECTEUR ETALLONE D 1.2 MM	1.000	PCS	VL1185A0	DISTRIBUTEU R LAVAGE PLUS 2 VOIES PLUS	1.000	PCS	VL1190A0	DISTRIBUTEU R ENTREE LAVAGE PLUS	1.000	PCS	VL1214A0	CLAPET ANTI RETOUR BB6 BAIONETTE	1.000	PCS	VM1605A0	CLIP TWIST LOCK DIAM. 10,2-12,7 MM	3.000	PCS	VM2172A0	CLIP BLOCAGE POMPE AVEC CIRCUIT	4.000	PCS																				
Code	Description	Qté	UOM																																																						
VL1166A0	RACCORD EN L BB6-AL6	3.000	PCS																																																						
VL1174C0	INJECTEUR ETALLONE D 1.2 MM	1.000	PCS																																																						
VL1185A0	DISTRIBUTEU R LAVAGE PLUS 2 VOIES PLUS	1.000	PCS																																																						
VL1190A0	DISTRIBUTEU R ENTREE LAVAGE PLUS	1.000	PCS																																																						
VL1214A0	CLAPET ANTI RETOUR BB6 BAIONETTE	1.000	PCS																																																						
VM1605A0	CLIP TWIST LOCK DIAM. 10,2-12,7 MM	3.000	PCS																																																						
VM2172A0	CLIP BLOCAGE POMPE AVEC CIRCUIT	4.000	PCS																																																						
0H7820A	SUPPORT LAVAGE PLUS AVEC ELV STEAM		KVL1209A	KIT SYSTEME DE LAVAGE PLUS 3 TOURN USA	<table border="1"> <thead> <tr> <th>Code</th> <th>Description</th> <th>Qté</th> <th>UOM</th> </tr> </thead> <tbody> <tr> <td>0H2354A1</td> <td>TOLE SYSTEME LAVAGE PLUS XEVC-XEVL</td> <td>1.000</td> <td>PCS</td> </tr> <tr> <td>EL1450A0</td> <td>ELECTROVAN NE H2O AUTONETTOY ANTE USA</td> <td>4.000</td> <td>PCS</td> </tr> <tr> <td>GN1526A0</td> <td>O-RING D.INT6.9 SP1.8</td> <td>9.000</td> <td>PCS</td> </tr> <tr> <td>RC1018A0</td> <td>COLLIER ELASTIQUE D12 ZINGUE</td> <td>11.000</td> <td>PCS</td> </tr> <tr> <td>RC1019A0</td> <td>COLLIER ELASTIQUE D10 ZINGUE</td> <td>14.000</td> <td>PCS</td> </tr> <tr> <td>RC1130A0</td> <td>COLLIER 130X2.6</td> <td>1.000</td> <td>PCS</td> </tr> <tr> <td>RC1131A0</td> <td>COLLIER 200X2.6 NOIR</td> <td>3.000</td> <td>PCS</td> </tr> <tr> <td>RC1242A0</td> <td>EXTREMITE FERME</td> <td>2.000</td> <td>PCS</td> </tr> <tr> <td>RC1356A0</td> <td>RACCORD DROIT FIL FEMELLE 8X1/4 BSP</td> <td>1.000</td> <td>PCS</td> </tr> <tr> <td>RC1414A1</td> <td>COLLIER A COMPRESSIO N D11.5-12.5</td> <td>1.000</td> <td>PCS</td> </tr> <tr> <td>TB2652A0</td> <td></td> <td>1.000</td> <td>PCS</td> </tr> <tr> <td>TB2677A0</td> <td></td> <td>1.000</td> <td>PCS</td> </tr> </tbody> </table>	Code	Description	Qté	UOM	0H2354A1	TOLE SYSTEME LAVAGE PLUS XEVC-XEVL	1.000	PCS	EL1450A0	ELECTROVAN NE H2O AUTONETTOY ANTE USA	4.000	PCS	GN1526A0	O-RING D.INT6.9 SP1.8	9.000	PCS	RC1018A0	COLLIER ELASTIQUE D12 ZINGUE	11.000	PCS	RC1019A0	COLLIER ELASTIQUE D10 ZINGUE	14.000	PCS	RC1130A0	COLLIER 130X2.6	1.000	PCS	RC1131A0	COLLIER 200X2.6 NOIR	3.000	PCS	RC1242A0	EXTREMITE FERME	2.000	PCS	RC1356A0	RACCORD DROIT FIL FEMELLE 8X1/4 BSP	1.000	PCS	RC1414A1	COLLIER A COMPRESSIO N D11.5-12.5	1.000	PCS	TB2652A0		1.000	PCS	TB2677A0		1.000	PCS
Code	Description	Qté	UOM																																																						
0H2354A1	TOLE SYSTEME LAVAGE PLUS XEVC-XEVL	1.000	PCS																																																						
EL1450A0	ELECTROVAN NE H2O AUTONETTOY ANTE USA	4.000	PCS																																																						
GN1526A0	O-RING D.INT6.9 SP1.8	9.000	PCS																																																						
RC1018A0	COLLIER ELASTIQUE D12 ZINGUE	11.000	PCS																																																						
RC1019A0	COLLIER ELASTIQUE D10 ZINGUE	14.000	PCS																																																						
RC1130A0	COLLIER 130X2.6	1.000	PCS																																																						
RC1131A0	COLLIER 200X2.6 NOIR	3.000	PCS																																																						
RC1242A0	EXTREMITE FERME	2.000	PCS																																																						
RC1356A0	RACCORD DROIT FIL FEMELLE 8X1/4 BSP	1.000	PCS																																																						
RC1414A1	COLLIER A COMPRESSIO N D11.5-12.5	1.000	PCS																																																						
TB2652A0		1.000	PCS																																																						
TB2677A0		1.000	PCS																																																						

COMPOSANT			PIÈCE DE RECHANGE																																																																																						
Code	Description	Image	Code	Description	Composants du kit																																																																																				
0H7820A	SUPPORT LAVAGE PLUS AVEC ELV STEAM		KVL1209A	KIT SYSTEME DE LAVAGE PLUS 3 TOURN USA	<table border="1"> <thead> <tr> <th>Code</th> <th>Description</th> <th>Qté</th> <th>UOM</th> </tr> </thead> <tbody> <tr> <td>TB2821A0</td> <td>TB2820A-L=40 MM EPDM NOI</td> <td>4.000</td> <td>PCS</td> </tr> <tr> <td>TB3004A0</td> <td>TB2820A L=550mm EPDM BLACK PIPE</td> <td>2.000</td> <td>PCS</td> </tr> <tr> <td>TB3024C0</td> <td></td> <td>3.000</td> <td>PCS</td> </tr> <tr> <td>TB3226A0</td> <td></td> <td>1.000</td> <td>PCS</td> </tr> <tr> <td>TB3440A0</td> <td>TB3132A L=1050mm EPDM WHITE-BLUE PIPE</td> <td>1.000</td> <td>PCS</td> </tr> <tr> <td>TB3614A0</td> <td></td> <td>1.000</td> <td>PCS</td> </tr> <tr> <td>VI1220A1</td> <td>VIS AUTOTARADE UX 4.2x12 TCB MARUTEX PRE</td> <td>1.000</td> <td>PCS</td> </tr> <tr> <td>VL1019A0</td> <td>POMPE DETERGENT VIBRATION</td> <td>1.000</td> <td>PCS</td> </tr> <tr> <td>VL1065A1</td> <td>PRESSOSTAT N.O. 1/4 M CIL</td> <td>1.000</td> <td>PCS</td> </tr> <tr> <td>VL1102A1</td> <td>FILTRE DANS LA LIGNE DET+VNR BARBED 6MM</td> <td>1.000</td> <td>PCS</td> </tr> <tr> <td>VL1127A1</td> <td>RACCORD T BARBED 6mm</td> <td>2.000</td> <td>PCS</td> </tr> <tr> <td>VL1128A1</td> <td>CLAPET ANTIRETOUR BARBED D6</td> <td>2.000</td> <td>PCS</td> </tr> <tr> <td>VL1166A0</td> <td>RACCORD EN L BB6-AL6</td> <td>4.000</td> <td>PCS</td> </tr> <tr> <td>VL1167A2</td> <td>REDUCTEUR DE DEBIT 3 BRAS DE LAVAGE GN21</td> <td>1.000</td> <td>PCS</td> </tr> <tr> <td>VL1174C0</td> <td>INJECTEUR ETALLONE D 1.2 MM</td> <td>1.000</td> <td>PCS</td> </tr> <tr> <td>VL1186A0</td> <td>DISTRIBUTEUR R LAVAGE PLUS 3 VOIES GICLEUR</td> <td>1.000</td> <td>PCS</td> </tr> <tr> <td>VL1190A0</td> <td>DISTRIBUTEUR R ENTREE LAVAGE PLUS</td> <td>1.000</td> <td>PCS</td> </tr> <tr> <td>VL1214A0</td> <td>CLAPET ANTI RETOUR BB6 BAIONETTE</td> <td>1.000</td> <td>PCS</td> </tr> <tr> <td>VM1605A0</td> <td>CLIP TWIST LOCK DIAM. 10,2-12,7 MM</td> <td>3.000</td> <td>PCS</td> </tr> <tr> <td>VM2172A0</td> <td>CLIP BLOCAGE POMPE AVEC CIRCUIT</td> <td>5.000</td> <td>PCS</td> </tr> </tbody> </table>	Code	Description	Qté	UOM	TB2821A0	TB2820A-L=40 MM EPDM NOI	4.000	PCS	TB3004A0	TB2820A L=550mm EPDM BLACK PIPE	2.000	PCS	TB3024C0		3.000	PCS	TB3226A0		1.000	PCS	TB3440A0	TB3132A L=1050mm EPDM WHITE-BLUE PIPE	1.000	PCS	TB3614A0		1.000	PCS	VI1220A1	VIS AUTOTARADE UX 4.2x12 TCB MARUTEX PRE	1.000	PCS	VL1019A0	POMPE DETERGENT VIBRATION	1.000	PCS	VL1065A1	PRESSOSTAT N.O. 1/4 M CIL	1.000	PCS	VL1102A1	FILTRE DANS LA LIGNE DET+VNR BARBED 6MM	1.000	PCS	VL1127A1	RACCORD T BARBED 6mm	2.000	PCS	VL1128A1	CLAPET ANTIRETOUR BARBED D6	2.000	PCS	VL1166A0	RACCORD EN L BB6-AL6	4.000	PCS	VL1167A2	REDUCTEUR DE DEBIT 3 BRAS DE LAVAGE GN21	1.000	PCS	VL1174C0	INJECTEUR ETALLONE D 1.2 MM	1.000	PCS	VL1186A0	DISTRIBUTEUR R LAVAGE PLUS 3 VOIES GICLEUR	1.000	PCS	VL1190A0	DISTRIBUTEUR R ENTREE LAVAGE PLUS	1.000	PCS	VL1214A0	CLAPET ANTI RETOUR BB6 BAIONETTE	1.000	PCS	VM1605A0	CLIP TWIST LOCK DIAM. 10,2-12,7 MM	3.000	PCS	VM2172A0	CLIP BLOCAGE POMPE AVEC CIRCUIT	5.000	PCS
					Code	Description	Qté	UOM																																																																																	
					TB2821A0	TB2820A-L=40 MM EPDM NOI	4.000	PCS																																																																																	
					TB3004A0	TB2820A L=550mm EPDM BLACK PIPE	2.000	PCS																																																																																	
					TB3024C0		3.000	PCS																																																																																	
					TB3226A0		1.000	PCS																																																																																	
					TB3440A0	TB3132A L=1050mm EPDM WHITE-BLUE PIPE	1.000	PCS																																																																																	
					TB3614A0		1.000	PCS																																																																																	
					VI1220A1	VIS AUTOTARADE UX 4.2x12 TCB MARUTEX PRE	1.000	PCS																																																																																	
					VL1019A0	POMPE DETERGENT VIBRATION	1.000	PCS																																																																																	
					VL1065A1	PRESSOSTAT N.O. 1/4 M CIL	1.000	PCS																																																																																	
					VL1102A1	FILTRE DANS LA LIGNE DET+VNR BARBED 6MM	1.000	PCS																																																																																	
					VL1127A1	RACCORD T BARBED 6mm	2.000	PCS																																																																																	
					VL1128A1	CLAPET ANTIRETOUR BARBED D6	2.000	PCS																																																																																	
					VL1166A0	RACCORD EN L BB6-AL6	4.000	PCS																																																																																	
					VL1167A2	REDUCTEUR DE DEBIT 3 BRAS DE LAVAGE GN21	1.000	PCS																																																																																	
					VL1174C0	INJECTEUR ETALLONE D 1.2 MM	1.000	PCS																																																																																	
					VL1186A0	DISTRIBUTEUR R LAVAGE PLUS 3 VOIES GICLEUR	1.000	PCS																																																																																	
					VL1190A0	DISTRIBUTEUR R ENTREE LAVAGE PLUS	1.000	PCS																																																																																	
					VL1214A0	CLAPET ANTI RETOUR BB6 BAIONETTE	1.000	PCS																																																																																	
					VM1605A0	CLIP TWIST LOCK DIAM. 10,2-12,7 MM	3.000	PCS																																																																																	
VM2172A0	CLIP BLOCAGE POMPE AVEC CIRCUIT	5.000	PCS																																																																																						

COMPOSANT			PIÈCE DE RECHANGE																																																																						
Code	Description	Image	Code	Description	Composants du kit																																																																				
0H7820A	SUPPORT LAVAGE PLUS AVEC ELV STEAM		KVL1208A	KIT SYSTEME DE LAVAGE PLUS 2 TOURN USA	<table border="1"> <thead> <tr> <th>Code</th> <th>Description</th> <th>Qté</th> <th>UOM</th> </tr> </thead> <tbody> <tr> <td>0H2354A1</td> <td>TOLE SYSTEME LAVAGE PLUS XEVC-XEVL</td> <td>1.000</td> <td>PCS</td> </tr> <tr> <td>EL1450A0</td> <td>ELECTROVAN NE H2O AUTONETTOY ANTE USA</td> <td>4.000</td> <td>PCS</td> </tr> <tr> <td>GN1526A0</td> <td>O-RING D.INT6.9 SP1.8</td> <td>9.000</td> <td>PCS</td> </tr> <tr> <td>RC1018A0</td> <td>COLLIER ELASTIQUE D12 ZINGUE</td> <td>3.000</td> <td>PCS</td> </tr> <tr> <td>RC1019A0</td> <td>COLLIER ELASTIQUE D10 ZINGUE</td> <td>2.000</td> <td>PCS</td> </tr> <tr> <td>RC1130A0</td> <td>COLLIER 130X2.6</td> <td>1.000</td> <td>PCS</td> </tr> <tr> <td>RC1131A0</td> <td>COLLIER 200X2.6 NOIR</td> <td>3.000</td> <td>PCS</td> </tr> <tr> <td>RC1242A0</td> <td>EXTREMITE FERME</td> <td>2.000</td> <td>PCS</td> </tr> <tr> <td>RC1356A0</td> <td>RACCORD DROIT FIL FEMELLE 8X1/4 BSP</td> <td>1.000</td> <td>PCS</td> </tr> <tr> <td>RC1414A1</td> <td>COLLIER A COMPRESSIO N D11.5-12.5</td> <td>4.000</td> <td>PCS</td> </tr> <tr> <td>TB2821A0</td> <td>TB2820A-L=40 MM EPDM NOI</td> <td>6.000</td> <td>PCS</td> </tr> <tr> <td>TB2994A0</td> <td>TB2820A0-TUY AU DETERGENT CAMPANAS 1</td> <td>1.000</td> <td>PCS</td> </tr> <tr> <td>TB3004A0</td> <td>TB2820A L=550mm EPDM BLACK PIPE</td> <td>1.000</td> <td>PCS</td> </tr> <tr> <td>TB3005B0</td> <td>TB3132A L=550mm EPDM WHITE-BLUE PIPE</td> <td>1.000</td> <td>PCS</td> </tr> <tr> <td>TB3440A0</td> <td>TB3132A L=1050mm EPDM WHITE-BLUE PIPE</td> <td>1.000</td> <td>PCS</td> </tr> <tr> <td>VL1019A0</td> <td>POMPE DETERGENT VIBRATION</td> <td>1.000</td> <td>PCS</td> </tr> </tbody> </table>	Code	Description	Qté	UOM	0H2354A1	TOLE SYSTEME LAVAGE PLUS XEVC-XEVL	1.000	PCS	EL1450A0	ELECTROVAN NE H2O AUTONETTOY ANTE USA	4.000	PCS	GN1526A0	O-RING D.INT6.9 SP1.8	9.000	PCS	RC1018A0	COLLIER ELASTIQUE D12 ZINGUE	3.000	PCS	RC1019A0	COLLIER ELASTIQUE D10 ZINGUE	2.000	PCS	RC1130A0	COLLIER 130X2.6	1.000	PCS	RC1131A0	COLLIER 200X2.6 NOIR	3.000	PCS	RC1242A0	EXTREMITE FERME	2.000	PCS	RC1356A0	RACCORD DROIT FIL FEMELLE 8X1/4 BSP	1.000	PCS	RC1414A1	COLLIER A COMPRESSIO N D11.5-12.5	4.000	PCS	TB2821A0	TB2820A-L=40 MM EPDM NOI	6.000	PCS	TB2994A0	TB2820A0-TUY AU DETERGENT CAMPANAS 1	1.000	PCS	TB3004A0	TB2820A L=550mm EPDM BLACK PIPE	1.000	PCS	TB3005B0	TB3132A L=550mm EPDM WHITE-BLUE PIPE	1.000	PCS	TB3440A0	TB3132A L=1050mm EPDM WHITE-BLUE PIPE	1.000	PCS	VL1019A0	POMPE DETERGENT VIBRATION	1.000	PCS
Code	Description	Qté	UOM																																																																						
0H2354A1	TOLE SYSTEME LAVAGE PLUS XEVC-XEVL	1.000	PCS																																																																						
EL1450A0	ELECTROVAN NE H2O AUTONETTOY ANTE USA	4.000	PCS																																																																						
GN1526A0	O-RING D.INT6.9 SP1.8	9.000	PCS																																																																						
RC1018A0	COLLIER ELASTIQUE D12 ZINGUE	3.000	PCS																																																																						
RC1019A0	COLLIER ELASTIQUE D10 ZINGUE	2.000	PCS																																																																						
RC1130A0	COLLIER 130X2.6	1.000	PCS																																																																						
RC1131A0	COLLIER 200X2.6 NOIR	3.000	PCS																																																																						
RC1242A0	EXTREMITE FERME	2.000	PCS																																																																						
RC1356A0	RACCORD DROIT FIL FEMELLE 8X1/4 BSP	1.000	PCS																																																																						
RC1414A1	COLLIER A COMPRESSIO N D11.5-12.5	4.000	PCS																																																																						
TB2821A0	TB2820A-L=40 MM EPDM NOI	6.000	PCS																																																																						
TB2994A0	TB2820A0-TUY AU DETERGENT CAMPANAS 1	1.000	PCS																																																																						
TB3004A0	TB2820A L=550mm EPDM BLACK PIPE	1.000	PCS																																																																						
TB3005B0	TB3132A L=550mm EPDM WHITE-BLUE PIPE	1.000	PCS																																																																						
TB3440A0	TB3132A L=1050mm EPDM WHITE-BLUE PIPE	1.000	PCS																																																																						
VL1019A0	POMPE DETERGENT VIBRATION	1.000	PCS																																																																						

COMPOSANT			PIÈCE DE RECHANGE																																																						
Code	Description	Image	Code	Description	Composants du kit																																																				
0H7820A	SUPPORT LAVAGE PLUS AVEC ELV STEAM		KVL1208A	KIT SYSTEME DE LAVAGE PLUS 2 TOURN USA	<table border="1"> <thead> <tr> <th>Code</th> <th>Description</th> <th>Qté</th> <th>UOM</th> </tr> </thead> <tbody> <tr> <td>VL1047A1</td> <td>PORTEGOMME D6-EXTREMIT E D8</td> <td>1.000</td> <td>PCS</td> </tr> <tr> <td>VL1065A1</td> <td>PRESSOSTAT N.O. 1/4 M CIL</td> <td>1.000</td> <td>PCS</td> </tr> <tr> <td>VL1102A1</td> <td>FILTRE DANS LA LIGNE DET+VNR BARBED 6MM</td> <td>1.000</td> <td>PCS</td> </tr> <tr> <td>VL1128A1</td> <td>CLAPET ANTIRETOUR BARBED D6</td> <td>2.000</td> <td>PCS</td> </tr> <tr> <td>VL1141A1</td> <td>RACCORD DROIT BB6-BB</td> <td>1.000</td> <td>PCS</td> </tr> <tr> <td>VL1166A0</td> <td>RACCORD EN L BB6-AL6</td> <td>4.000</td> <td>PCS</td> </tr> <tr> <td>VL1174C0</td> <td>INJECTEUR ETALLONE D 1.2 MM</td> <td>1.000</td> <td>PCS</td> </tr> <tr> <td>VL1186A0</td> <td>DISTRIBUTEUR R LAVAGE PLUS 3 VOIES GICLEUR</td> <td>1.000</td> <td>PCS</td> </tr> <tr> <td>VL1190A0</td> <td>DISTRIBUTEUR R ENTREE LAVAGE PLUS</td> <td>1.000</td> <td>PCS</td> </tr> <tr> <td>VL1214A0</td> <td>CLAPET ANTI RETOUR BB6 BAIONETTE</td> <td>1.000</td> <td>PCS</td> </tr> <tr> <td>VM1605A0</td> <td>CLIP TWIST LOCK DIAM. 10.2-12.7 MM</td> <td>3.000</td> <td>PCS</td> </tr> <tr> <td>VM2172A0</td> <td>CLIP BLOCAGE POMPE AVEC CIRCUIT</td> <td>5.000</td> <td>PCS</td> </tr> </tbody> </table>	Code	Description	Qté	UOM	VL1047A1	PORTEGOMME D6-EXTREMIT E D8	1.000	PCS	VL1065A1	PRESSOSTAT N.O. 1/4 M CIL	1.000	PCS	VL1102A1	FILTRE DANS LA LIGNE DET+VNR BARBED 6MM	1.000	PCS	VL1128A1	CLAPET ANTIRETOUR BARBED D6	2.000	PCS	VL1141A1	RACCORD DROIT BB6-BB	1.000	PCS	VL1166A0	RACCORD EN L BB6-AL6	4.000	PCS	VL1174C0	INJECTEUR ETALLONE D 1.2 MM	1.000	PCS	VL1186A0	DISTRIBUTEUR R LAVAGE PLUS 3 VOIES GICLEUR	1.000	PCS	VL1190A0	DISTRIBUTEUR R ENTREE LAVAGE PLUS	1.000	PCS	VL1214A0	CLAPET ANTI RETOUR BB6 BAIONETTE	1.000	PCS	VM1605A0	CLIP TWIST LOCK DIAM. 10.2-12.7 MM	3.000	PCS	VM2172A0	CLIP BLOCAGE POMPE AVEC CIRCUIT	5.000	PCS
			Code	Description	Qté	UOM																																																			
VL1047A1	PORTEGOMME D6-EXTREMIT E D8	1.000	PCS																																																						
VL1065A1	PRESSOSTAT N.O. 1/4 M CIL	1.000	PCS																																																						
VL1102A1	FILTRE DANS LA LIGNE DET+VNR BARBED 6MM	1.000	PCS																																																						
VL1128A1	CLAPET ANTIRETOUR BARBED D6	2.000	PCS																																																						
VL1141A1	RACCORD DROIT BB6-BB	1.000	PCS																																																						
VL1166A0	RACCORD EN L BB6-AL6	4.000	PCS																																																						
VL1174C0	INJECTEUR ETALLONE D 1.2 MM	1.000	PCS																																																						
VL1186A0	DISTRIBUTEUR R LAVAGE PLUS 3 VOIES GICLEUR	1.000	PCS																																																						
VL1190A0	DISTRIBUTEUR R ENTREE LAVAGE PLUS	1.000	PCS																																																						
VL1214A0	CLAPET ANTI RETOUR BB6 BAIONETTE	1.000	PCS																																																						
VM1605A0	CLIP TWIST LOCK DIAM. 10.2-12.7 MM	3.000	PCS																																																						
VM2172A0	CLIP BLOCAGE POMPE AVEC CIRCUIT	5.000	PCS																																																						
KVL1207A	KIT SYSTEME LAVAGE PLUS 1 TURBINE USA	<table border="1"> <thead> <tr> <th>Code</th> <th>Description</th> <th>Qté</th> <th>UOM</th> </tr> </thead> <tbody> <tr> <td>0H2354A1</td> <td>TOILE SYSTEME LAVAGE PLUS XEVC-XEVL</td> <td>1.000</td> <td>PCS</td> </tr> <tr> <td>EL1450A0</td> <td>ELECTROVAN NE H2O AUTONETTOY ANTE USA</td> <td>3.000</td> <td>PCS</td> </tr> <tr> <td>GN1526A0</td> <td>O-RING D.INT6.9 SP1.8</td> <td>7.000</td> <td>PCS</td> </tr> <tr> <td>RC1018A0</td> <td>COLLIER ELASTIQUE D12 ZINGUE</td> <td>1.000</td> <td>PCS</td> </tr> <tr> <td>RC1019A0</td> <td>COLLIER ELASTIQUE D10 ZINGUE</td> <td>12.000</td> <td>PCS</td> </tr> </tbody> </table>	Code	Description	Qté	UOM	0H2354A1	TOILE SYSTEME LAVAGE PLUS XEVC-XEVL	1.000	PCS	EL1450A0	ELECTROVAN NE H2O AUTONETTOY ANTE USA	3.000	PCS	GN1526A0	O-RING D.INT6.9 SP1.8	7.000	PCS	RC1018A0	COLLIER ELASTIQUE D12 ZINGUE	1.000	PCS	RC1019A0	COLLIER ELASTIQUE D10 ZINGUE	12.000	PCS																															
Code	Description	Qté	UOM																																																						
0H2354A1	TOILE SYSTEME LAVAGE PLUS XEVC-XEVL	1.000	PCS																																																						
EL1450A0	ELECTROVAN NE H2O AUTONETTOY ANTE USA	3.000	PCS																																																						
GN1526A0	O-RING D.INT6.9 SP1.8	7.000	PCS																																																						
RC1018A0	COLLIER ELASTIQUE D12 ZINGUE	1.000	PCS																																																						
RC1019A0	COLLIER ELASTIQUE D10 ZINGUE	12.000	PCS																																																						

COMPOSANT			PIÈCE DE RECHANGE																																																																																						
Code	Description	Image	Code	Description	Composants du kit																																																																																				
OH7820A	SUPPORT LAVAGE PLUS AVEC ELV STEAM		KVL1207A	KIT SYSTEME LAVAGE PLUS 1 TURBINE USA	<table border="1"> <thead> <tr> <th>Code</th> <th>Description</th> <th>Qté</th> <th>UOM</th> </tr> </thead> <tbody> <tr> <td>RC1130A0</td> <td>COLLIER 130X2.6</td> <td>1.000</td> <td>PCS</td> </tr> <tr> <td>RC1131A0</td> <td>COLLIER 200X2.6 NOIR</td> <td>2.000</td> <td>PCS</td> </tr> <tr> <td>RC1242A0</td> <td>EXTREMITE FERME</td> <td>2.000</td> <td>PCS</td> </tr> <tr> <td>RC1356A0</td> <td>RACCORD DROIT FIL FEMELLE 8X1/4 BSP</td> <td>1.000</td> <td>PCS</td> </tr> <tr> <td>RC1414A1</td> <td>COLLIER A COMPRESSIO N D11.5-12.5</td> <td>5.000</td> <td>PCS</td> </tr> <tr> <td>TB2821A0</td> <td>TB2820A-L=40 MM EPDM NOI</td> <td>4.000</td> <td>PCS</td> </tr> <tr> <td>TB3004A0</td> <td>TB2820A L=550mm EPDM BLACK PIPE</td> <td>1.000</td> <td>PCS</td> </tr> <tr> <td>TB3005B0</td> <td>TB3132A L=550mm EPDM WHITE-BLUE PIPE</td> <td>2.000</td> <td>PCS</td> </tr> <tr> <td>TB3024C0</td> <td></td> <td>1.000</td> <td>PCS</td> </tr> <tr> <td>TB3225B0</td> <td>TB2820A-L=67 0MM EPDM NOIR</td> <td>1.000</td> <td>PCS</td> </tr> <tr> <td>TB3252A0</td> <td>TB3252A0</td> <td>1.000</td> <td>PCS</td> </tr> <tr> <td>TB3614A0</td> <td></td> <td>1.000</td> <td>PCS</td> </tr> <tr> <td>VI1220A1</td> <td>VIS AUTOTARADE UX 4.2x12 TCB MARUTEX PRE</td> <td>1.000</td> <td>PCS</td> </tr> <tr> <td>VL1019A0</td> <td>POMPE DETERGENT VIBRATION</td> <td>1.000</td> <td>PCS</td> </tr> <tr> <td>VL1047A1</td> <td>PORTEGOMME D6-EXTREMIT E D8</td> <td>1.000</td> <td>PCS</td> </tr> <tr> <td>VL1102A1</td> <td>FILTRE DANS LA LIGNE DET+VNR BARBED 6MM</td> <td>1.000</td> <td>PCS</td> </tr> <tr> <td>VL1127A1</td> <td>RACCORD T BARBED 6mm</td> <td>1.000</td> <td>PCS</td> </tr> <tr> <td>VL1128A1</td> <td>CLAPET ANTIRETOUR BARBED D6</td> <td>1.000</td> <td>PCS</td> </tr> <tr> <td>VL1166A0</td> <td>RACCORD EN L BB6-AL6</td> <td>3.000</td> <td>PCS</td> </tr> <tr> <td>VL1174C0</td> <td>INJECTEUR ETALLONE D 1.2 MM</td> <td>1.000</td> <td>PCS</td> </tr> </tbody> </table>	Code	Description	Qté	UOM	RC1130A0	COLLIER 130X2.6	1.000	PCS	RC1131A0	COLLIER 200X2.6 NOIR	2.000	PCS	RC1242A0	EXTREMITE FERME	2.000	PCS	RC1356A0	RACCORD DROIT FIL FEMELLE 8X1/4 BSP	1.000	PCS	RC1414A1	COLLIER A COMPRESSIO N D11.5-12.5	5.000	PCS	TB2821A0	TB2820A-L=40 MM EPDM NOI	4.000	PCS	TB3004A0	TB2820A L=550mm EPDM BLACK PIPE	1.000	PCS	TB3005B0	TB3132A L=550mm EPDM WHITE-BLUE PIPE	2.000	PCS	TB3024C0		1.000	PCS	TB3225B0	TB2820A-L=67 0MM EPDM NOIR	1.000	PCS	TB3252A0	TB3252A0	1.000	PCS	TB3614A0		1.000	PCS	VI1220A1	VIS AUTOTARADE UX 4.2x12 TCB MARUTEX PRE	1.000	PCS	VL1019A0	POMPE DETERGENT VIBRATION	1.000	PCS	VL1047A1	PORTEGOMME D6-EXTREMIT E D8	1.000	PCS	VL1102A1	FILTRE DANS LA LIGNE DET+VNR BARBED 6MM	1.000	PCS	VL1127A1	RACCORD T BARBED 6mm	1.000	PCS	VL1128A1	CLAPET ANTIRETOUR BARBED D6	1.000	PCS	VL1166A0	RACCORD EN L BB6-AL6	3.000	PCS	VL1174C0	INJECTEUR ETALLONE D 1.2 MM	1.000	PCS
					Code	Description	Qté	UOM																																																																																	
					RC1130A0	COLLIER 130X2.6	1.000	PCS																																																																																	
					RC1131A0	COLLIER 200X2.6 NOIR	2.000	PCS																																																																																	
					RC1242A0	EXTREMITE FERME	2.000	PCS																																																																																	
					RC1356A0	RACCORD DROIT FIL FEMELLE 8X1/4 BSP	1.000	PCS																																																																																	
					RC1414A1	COLLIER A COMPRESSIO N D11.5-12.5	5.000	PCS																																																																																	
					TB2821A0	TB2820A-L=40 MM EPDM NOI	4.000	PCS																																																																																	
					TB3004A0	TB2820A L=550mm EPDM BLACK PIPE	1.000	PCS																																																																																	
					TB3005B0	TB3132A L=550mm EPDM WHITE-BLUE PIPE	2.000	PCS																																																																																	
					TB3024C0		1.000	PCS																																																																																	
					TB3225B0	TB2820A-L=67 0MM EPDM NOIR	1.000	PCS																																																																																	
					TB3252A0	TB3252A0	1.000	PCS																																																																																	
					TB3614A0		1.000	PCS																																																																																	
					VI1220A1	VIS AUTOTARADE UX 4.2x12 TCB MARUTEX PRE	1.000	PCS																																																																																	
					VL1019A0	POMPE DETERGENT VIBRATION	1.000	PCS																																																																																	
					VL1047A1	PORTEGOMME D6-EXTREMIT E D8	1.000	PCS																																																																																	
					VL1102A1	FILTRE DANS LA LIGNE DET+VNR BARBED 6MM	1.000	PCS																																																																																	
					VL1127A1	RACCORD T BARBED 6mm	1.000	PCS																																																																																	
					VL1128A1	CLAPET ANTIRETOUR BARBED D6	1.000	PCS																																																																																	
VL1166A0	RACCORD EN L BB6-AL6	3.000	PCS																																																																																						
VL1174C0	INJECTEUR ETALLONE D 1.2 MM	1.000	PCS																																																																																						



COMPOSANT			PIÈCE DE RECHANGE																																																							
Code	Description	Image	Code	Description	Composants du kit																																																					
0H7820A	SUPPORT LAVAGE PLUS AVEC ELV STEAM		KVL1207A	KIT SYSTEME LAVAGE PLUS 1 TURBINE USA	<table border="1"> <thead> <tr> <th>Code</th> <th>Description</th> <th>Qté</th> <th>UOM</th> </tr> </thead> <tbody> <tr> <td>VL1185A0</td> <td>DISTRIBUTEU R LAVAGE PLUS 2 VOIES PLUS</td> <td>1.000</td> <td>PCS</td> </tr> <tr> <td>VL1190A0</td> <td>DISTRIBUTEU R ENTREE LAVAGE PLUS</td> <td>1.000</td> <td>PCS</td> </tr> <tr> <td>VL1214A0</td> <td>CLAPET ANTI RETOUR BB6 BAIONNETTE</td> <td>1.000</td> <td>PCS</td> </tr> <tr> <td>VL1398A0</td> <td>PRESSOSTAT N.O. 1/4 M CIL</td> <td>1.000</td> <td>PCS</td> </tr> <tr> <td>VM1605A0</td> <td>CLIP TWIST LOCK DIAM. 10,2-12,7 MM</td> <td>3.000</td> <td>PCS</td> </tr> <tr> <td>VM2172A0</td> <td>CLIP BLOCAGE POMPE AVEC CIRCUIT</td> <td>4.000</td> <td>PCS</td> </tr> </tbody> </table>	Code	Description	Qté	UOM	VL1185A0	DISTRIBUTEU R LAVAGE PLUS 2 VOIES PLUS	1.000	PCS	VL1190A0	DISTRIBUTEU R ENTREE LAVAGE PLUS	1.000	PCS	VL1214A0	CLAPET ANTI RETOUR BB6 BAIONNETTE	1.000	PCS	VL1398A0	PRESSOSTAT N.O. 1/4 M CIL	1.000	PCS	VM1605A0	CLIP TWIST LOCK DIAM. 10,2-12,7 MM	3.000	PCS	VM2172A0	CLIP BLOCAGE POMPE AVEC CIRCUIT	4.000	PCS																									
			Code	Description	Qté	UOM																																																				
VL1185A0	DISTRIBUTEU R LAVAGE PLUS 2 VOIES PLUS	1.000	PCS																																																							
VL1190A0	DISTRIBUTEU R ENTREE LAVAGE PLUS	1.000	PCS																																																							
VL1214A0	CLAPET ANTI RETOUR BB6 BAIONNETTE	1.000	PCS																																																							
VL1398A0	PRESSOSTAT N.O. 1/4 M CIL	1.000	PCS																																																							
VM1605A0	CLIP TWIST LOCK DIAM. 10,2-12,7 MM	3.000	PCS																																																							
VM2172A0	CLIP BLOCAGE POMPE AVEC CIRCUIT	4.000	PCS																																																							
KVL1187A	KIT SYSTEME LAVAGE 3 TOURNIQUETS EU	<table border="1"> <thead> <tr> <th>Code</th> <th>Description</th> <th>Qté</th> <th>UOM</th> </tr> </thead> <tbody> <tr> <td>0H2354A1</td> <td>TOLE SYSTEME LAVAGE PLUS XEVC-XEVL</td> <td>1.000</td> <td>PCS</td> </tr> <tr> <td>EL1440A0</td> <td>ELECTROVAN NE H20 AUTONETTOY ANTE BAIONNET</td> <td>4.000</td> <td>PCS</td> </tr> <tr> <td>GN1526A0</td> <td>O-RING D.INT6,9 SP1,8</td> <td>9.000</td> <td>PCS</td> </tr> <tr> <td>RC1018A0</td> <td>COLLIER ELASTIQUE D12 ZINGUE</td> <td>11.000</td> <td>PCS</td> </tr> <tr> <td>RC1019A0</td> <td>COLLIER ELASTIQUE D10 ZINGUE</td> <td>14.000</td> <td>PCS</td> </tr> <tr> <td>RC1130A0</td> <td>COLLIER 130X2,6</td> <td>1.000</td> <td>PCS</td> </tr> <tr> <td>RC1131A0</td> <td>COLLIER 200X2,6 NOIR</td> <td>3.000</td> <td>PCS</td> </tr> <tr> <td>RC1242A0</td> <td>EXTREMITE FERME</td> <td>2.000</td> <td>PCS</td> </tr> <tr> <td>RC1356A0</td> <td>RACCORD DROIT FIL FEMELLE 8X1/4 BSP</td> <td>1.000</td> <td>PCS</td> </tr> <tr> <td>RC1414A1</td> <td>COLLIER A COMPRESSIO N D11.5-12.5</td> <td>1.000</td> <td>PCS</td> </tr> <tr> <td>TB2652A0</td> <td></td> <td>1.000</td> <td>PCS</td> </tr> <tr> <td>TB2677A0</td> <td></td> <td>1.000</td> <td>PCS</td> </tr> <tr> <td>TB2821A0</td> <td>TB2820A-L=40 MM EPDM NOI</td> <td>4.000</td> <td>PCS</td> </tr> </tbody> </table>	Code	Description	Qté	UOM	0H2354A1	TOLE SYSTEME LAVAGE PLUS XEVC-XEVL	1.000	PCS	EL1440A0	ELECTROVAN NE H20 AUTONETTOY ANTE BAIONNET	4.000	PCS	GN1526A0	O-RING D.INT6,9 SP1,8	9.000	PCS	RC1018A0	COLLIER ELASTIQUE D12 ZINGUE	11.000	PCS	RC1019A0	COLLIER ELASTIQUE D10 ZINGUE	14.000	PCS	RC1130A0	COLLIER 130X2,6	1.000	PCS	RC1131A0	COLLIER 200X2,6 NOIR	3.000	PCS	RC1242A0	EXTREMITE FERME	2.000	PCS	RC1356A0	RACCORD DROIT FIL FEMELLE 8X1/4 BSP	1.000	PCS	RC1414A1	COLLIER A COMPRESSIO N D11.5-12.5	1.000	PCS	TB2652A0		1.000	PCS	TB2677A0		1.000	PCS	TB2821A0	TB2820A-L=40 MM EPDM NOI	4.000	PCS
Code	Description	Qté	UOM																																																							
0H2354A1	TOLE SYSTEME LAVAGE PLUS XEVC-XEVL	1.000	PCS																																																							
EL1440A0	ELECTROVAN NE H20 AUTONETTOY ANTE BAIONNET	4.000	PCS																																																							
GN1526A0	O-RING D.INT6,9 SP1,8	9.000	PCS																																																							
RC1018A0	COLLIER ELASTIQUE D12 ZINGUE	11.000	PCS																																																							
RC1019A0	COLLIER ELASTIQUE D10 ZINGUE	14.000	PCS																																																							
RC1130A0	COLLIER 130X2,6	1.000	PCS																																																							
RC1131A0	COLLIER 200X2,6 NOIR	3.000	PCS																																																							
RC1242A0	EXTREMITE FERME	2.000	PCS																																																							
RC1356A0	RACCORD DROIT FIL FEMELLE 8X1/4 BSP	1.000	PCS																																																							
RC1414A1	COLLIER A COMPRESSIO N D11.5-12.5	1.000	PCS																																																							
TB2652A0		1.000	PCS																																																							
TB2677A0		1.000	PCS																																																							
TB2821A0	TB2820A-L=40 MM EPDM NOI	4.000	PCS																																																							



COMPOSANT			PIÈCE DE RECHANGE																																																																														
Code	Description	Image	Code	Description	Composants du kit																																																																												
0H7820A	SUPPORT LAVAGE PLUS AVEC ELV STEAM		KVL1187A	KIT SYSTEME LAVAGE 3 TOURNIQUETS EU	<table border="1"> <thead> <tr> <th>Code</th> <th>Description</th> <th>Qté</th> <th>UOM</th> </tr> </thead> <tbody> <tr> <td>TB3004A0</td> <td>TB2820A L=550mm EPDM BLACK PIPE</td> <td>2.000</td> <td>PCS</td> </tr> <tr> <td>TB3024C0</td> <td></td> <td>3.000</td> <td>PCS</td> </tr> <tr> <td>TB3226A0</td> <td></td> <td>1.000</td> <td>PCS</td> </tr> <tr> <td>TB3440A0</td> <td>TB3132A L=1050mm EPDM WHITE-BLUE PIPE</td> <td>1.000</td> <td>PCS</td> </tr> <tr> <td>TB3614A0</td> <td></td> <td>1.000</td> <td>PCS</td> </tr> <tr> <td>VI1220A1</td> <td>VIS AUTOTARADE UX 4.2x12 TCB MARUTEX PRE</td> <td>1.000</td> <td>PCS</td> </tr> <tr> <td>VL1019A0</td> <td>POMPE DETERGENT VIBRATION</td> <td>1.000</td> <td>PCS</td> </tr> <tr> <td>VL1047A1</td> <td>PORTEGOMM E D6-EXTREMIT E D8</td> <td>1.000</td> <td>PCS</td> </tr> <tr> <td>VL1065A1</td> <td>PRESSOSTAT N.O. 1/4 M CIL</td> <td>1.000</td> <td>PCS</td> </tr> <tr> <td>VL1102A1</td> <td>FILTRE DANS LA LIGNE DET+VNR BARBED 6MM</td> <td>1.000</td> <td>PCS</td> </tr> <tr> <td>VL1127A1</td> <td>RACCORD T BARBED 6mm</td> <td>2.000</td> <td>PCS</td> </tr> <tr> <td>VL1128A1</td> <td>CLAPET ANTIRETOUR BARBED D6</td> <td>2.000</td> <td>PCS</td> </tr> <tr> <td>VL1166A0</td> <td>RACCORD EN L BB6-AL6</td> <td>4.000</td> <td>PCS</td> </tr> <tr> <td>VL1167A2</td> <td>REDUCTEUR DE DEBIT 3 BRAS DE LAVAGE GN21</td> <td>1.000</td> <td>PCS</td> </tr> <tr> <td>VL1174C0</td> <td>INJECTEUR ETALLONE D 1.2 MM</td> <td>1.000</td> <td>PCS</td> </tr> <tr> <td>VL1186A0</td> <td>DISTRIBUTEU R LAVAGE PLUS 3 VOIES GICLEUR</td> <td>1.000</td> <td>PCS</td> </tr> <tr> <td>VL1190A0</td> <td>DISTRIBUTEU R ENTREE LAVAGE PLUS</td> <td>1.000</td> <td>PCS</td> </tr> <tr> <td>VL1214A0</td> <td>CLAPET ANTI RETOUR BB6 BAIONETTE</td> <td>1.000</td> <td>PCS</td> </tr> </tbody> </table>	Code	Description	Qté	UOM	TB3004A0	TB2820A L=550mm EPDM BLACK PIPE	2.000	PCS	TB3024C0		3.000	PCS	TB3226A0		1.000	PCS	TB3440A0	TB3132A L=1050mm EPDM WHITE-BLUE PIPE	1.000	PCS	TB3614A0		1.000	PCS	VI1220A1	VIS AUTOTARADE UX 4.2x12 TCB MARUTEX PRE	1.000	PCS	VL1019A0	POMPE DETERGENT VIBRATION	1.000	PCS	VL1047A1	PORTEGOMM E D6-EXTREMIT E D8	1.000	PCS	VL1065A1	PRESSOSTAT N.O. 1/4 M CIL	1.000	PCS	VL1102A1	FILTRE DANS LA LIGNE DET+VNR BARBED 6MM	1.000	PCS	VL1127A1	RACCORD T BARBED 6mm	2.000	PCS	VL1128A1	CLAPET ANTIRETOUR BARBED D6	2.000	PCS	VL1166A0	RACCORD EN L BB6-AL6	4.000	PCS	VL1167A2	REDUCTEUR DE DEBIT 3 BRAS DE LAVAGE GN21	1.000	PCS	VL1174C0	INJECTEUR ETALLONE D 1.2 MM	1.000	PCS	VL1186A0	DISTRIBUTEU R LAVAGE PLUS 3 VOIES GICLEUR	1.000	PCS	VL1190A0	DISTRIBUTEU R ENTREE LAVAGE PLUS	1.000	PCS	VL1214A0	CLAPET ANTI RETOUR BB6 BAIONETTE	1.000	PCS
					Code	Description	Qté	UOM																																																																									
					TB3004A0	TB2820A L=550mm EPDM BLACK PIPE	2.000	PCS																																																																									
					TB3024C0		3.000	PCS																																																																									
					TB3226A0		1.000	PCS																																																																									
					TB3440A0	TB3132A L=1050mm EPDM WHITE-BLUE PIPE	1.000	PCS																																																																									
					TB3614A0		1.000	PCS																																																																									
					VI1220A1	VIS AUTOTARADE UX 4.2x12 TCB MARUTEX PRE	1.000	PCS																																																																									
					VL1019A0	POMPE DETERGENT VIBRATION	1.000	PCS																																																																									
					VL1047A1	PORTEGOMM E D6-EXTREMIT E D8	1.000	PCS																																																																									
					VL1065A1	PRESSOSTAT N.O. 1/4 M CIL	1.000	PCS																																																																									
					VL1102A1	FILTRE DANS LA LIGNE DET+VNR BARBED 6MM	1.000	PCS																																																																									
					VL1127A1	RACCORD T BARBED 6mm	2.000	PCS																																																																									
					VL1128A1	CLAPET ANTIRETOUR BARBED D6	2.000	PCS																																																																									
					VL1166A0	RACCORD EN L BB6-AL6	4.000	PCS																																																																									
					VL1167A2	REDUCTEUR DE DEBIT 3 BRAS DE LAVAGE GN21	1.000	PCS																																																																									
					VL1174C0	INJECTEUR ETALLONE D 1.2 MM	1.000	PCS																																																																									
					VL1186A0	DISTRIBUTEU R LAVAGE PLUS 3 VOIES GICLEUR	1.000	PCS																																																																									
					VL1190A0	DISTRIBUTEU R ENTREE LAVAGE PLUS	1.000	PCS																																																																									
					VL1214A0	CLAPET ANTI RETOUR BB6 BAIONETTE	1.000	PCS																																																																									

COMPOSANT			PIÈCE DE RECHANGE																																																											
Code	Description	Image	Code	Description	Composants du kit																																																									
0H7820A	SUPPORT LAVAGE PLUS AVEC ELV STEAM		KVL1187A	KIT SYSTEME LAVAGE 3 TOURNIQUETS EU	<table border="1"> <thead> <tr> <th>Code</th> <th>Description</th> <th>Qté</th> <th>UOM</th> </tr> </thead> <tbody> <tr> <td>VM1605A0</td> <td>CLIP TWIST LOCK DIAM. 10,2-12,7 MM</td> <td>3.000</td> <td>PCS</td> </tr> <tr> <td>VM2172A0</td> <td>CLIP BLOCAGE POMPE AVEC CIRCUIT</td> <td>5.000</td> <td>PCS</td> </tr> </tbody> </table>	Code	Description	Qté	UOM	VM1605A0	CLIP TWIST LOCK DIAM. 10,2-12,7 MM	3.000	PCS	VM2172A0	CLIP BLOCAGE POMPE AVEC CIRCUIT	5.000	PCS																																													
			Code	Description	Qté	UOM																																																								
VM1605A0	CLIP TWIST LOCK DIAM. 10,2-12,7 MM	3.000	PCS																																																											
VM2172A0	CLIP BLOCAGE POMPE AVEC CIRCUIT	5.000	PCS																																																											
KVL1184A	KIT SYSTEME LAVAGE 2 TOURNIQUETS EU	<table border="1"> <thead> <tr> <th>Code</th> <th>Description</th> <th>Qté</th> <th>UOM</th> </tr> </thead> <tbody> <tr> <td>0H2354A1</td> <td>TOLE SYSTEME LAVAGE PLUS XEVC-XEVL</td> <td>1.000</td> <td>PCS</td> </tr> <tr> <td>EL1440A0</td> <td>ELECTROVAN NE H20 AUTONETTOY ANTE BAIONNET</td> <td>4.000</td> <td>PCS</td> </tr> <tr> <td>GN1526A0</td> <td>O-RING D.INT6,9 SP1.8</td> <td>9.000</td> <td>PCS</td> </tr> <tr> <td>RC1018A0</td> <td>COLLIER ELASTIQUE D12 ZINGUE</td> <td>2.000</td> <td>PCS</td> </tr> <tr> <td>RC1019A0</td> <td>COLLIER ELASTIQUE D10 ZINGUE</td> <td>13.000</td> <td>PCS</td> </tr> <tr> <td>RC1130A0</td> <td>COLLIER 130X2,6</td> <td>1.000</td> <td>PCS</td> </tr> <tr> <td>RC1131A0</td> <td>COLLIER 200X2,6 NOIR</td> <td>3.000</td> <td>PCS</td> </tr> <tr> <td>RC1242A0</td> <td>EXTREMITE FERME</td> <td>2.000</td> <td>PCS</td> </tr> <tr> <td>RC1356A0</td> <td>RACCORD DROIT FIL FEMELLE 8X1/4 BSP</td> <td>1.000</td> <td>PCS</td> </tr> <tr> <td>RC1414A1</td> <td>COLLIER A COMPRESSIO N D11.5-12.5</td> <td>1.000</td> <td>PCS</td> </tr> <tr> <td>TB2821A0</td> <td>TB2820A-L=40 MM EPDM NOI</td> <td>4.000</td> <td>PCS</td> </tr> <tr> <td>TB2994A0</td> <td>TB2820A0-TUY AU DETERGENT CAMPANAS 1</td> <td>1.000</td> <td>PCS</td> </tr> <tr> <td>TB3004A0</td> <td>TB2820A L=550mm EPDM BLACK PIPE</td> <td>2.000</td> <td>PCS</td> </tr> <tr> <td>TB3005B0</td> <td>TB3132A L=550mm EPDM WHITE-BLUE PIPE</td> <td>1.000</td> <td>PCS</td> </tr> </tbody> </table>	Code	Description	Qté	UOM	0H2354A1	TOLE SYSTEME LAVAGE PLUS XEVC-XEVL	1.000	PCS	EL1440A0	ELECTROVAN NE H20 AUTONETTOY ANTE BAIONNET	4.000	PCS	GN1526A0	O-RING D.INT6,9 SP1.8	9.000	PCS	RC1018A0	COLLIER ELASTIQUE D12 ZINGUE	2.000	PCS	RC1019A0	COLLIER ELASTIQUE D10 ZINGUE	13.000	PCS	RC1130A0	COLLIER 130X2,6	1.000	PCS	RC1131A0	COLLIER 200X2,6 NOIR	3.000	PCS	RC1242A0	EXTREMITE FERME	2.000	PCS	RC1356A0	RACCORD DROIT FIL FEMELLE 8X1/4 BSP	1.000	PCS	RC1414A1	COLLIER A COMPRESSIO N D11.5-12.5	1.000	PCS	TB2821A0	TB2820A-L=40 MM EPDM NOI	4.000	PCS	TB2994A0	TB2820A0-TUY AU DETERGENT CAMPANAS 1	1.000	PCS	TB3004A0	TB2820A L=550mm EPDM BLACK PIPE	2.000	PCS	TB3005B0	TB3132A L=550mm EPDM WHITE-BLUE PIPE	1.000	PCS
Code	Description	Qté	UOM																																																											
0H2354A1	TOLE SYSTEME LAVAGE PLUS XEVC-XEVL	1.000	PCS																																																											
EL1440A0	ELECTROVAN NE H20 AUTONETTOY ANTE BAIONNET	4.000	PCS																																																											
GN1526A0	O-RING D.INT6,9 SP1.8	9.000	PCS																																																											
RC1018A0	COLLIER ELASTIQUE D12 ZINGUE	2.000	PCS																																																											
RC1019A0	COLLIER ELASTIQUE D10 ZINGUE	13.000	PCS																																																											
RC1130A0	COLLIER 130X2,6	1.000	PCS																																																											
RC1131A0	COLLIER 200X2,6 NOIR	3.000	PCS																																																											
RC1242A0	EXTREMITE FERME	2.000	PCS																																																											
RC1356A0	RACCORD DROIT FIL FEMELLE 8X1/4 BSP	1.000	PCS																																																											
RC1414A1	COLLIER A COMPRESSIO N D11.5-12.5	1.000	PCS																																																											
TB2821A0	TB2820A-L=40 MM EPDM NOI	4.000	PCS																																																											
TB2994A0	TB2820A0-TUY AU DETERGENT CAMPANAS 1	1.000	PCS																																																											
TB3004A0	TB2820A L=550mm EPDM BLACK PIPE	2.000	PCS																																																											
TB3005B0	TB3132A L=550mm EPDM WHITE-BLUE PIPE	1.000	PCS																																																											

COMPOSANT			PIÈCE DE RECHANGE																																																																													
Code	Description	Image	Code	Description	Composants du kit																																																																											
0H7820A	SUPPORT LAVAGE PLUS AVEC ELV STEAM		KVL1184A	KIT SYSTEME LAVAGE 2 TOURNIQUETS EU	<table border="1"> <thead> <tr> <th>Code</th> <th>Description</th> <th>Qté</th> <th>UOM</th> </tr> </thead> <tbody> <tr> <td>TB3440A0</td> <td>TB3132A L=1050mm EPDM WHITE-BLUE PIPE</td> <td>1.000</td> <td>PCS</td> </tr> <tr> <td>TB3614A0</td> <td></td> <td>1.000</td> <td>PCS</td> </tr> <tr> <td>VI1220A1</td> <td>VIS AUTOTARADE UX 4.2x12 TCB MARUTEX PRE</td> <td>1.000</td> <td>PCS</td> </tr> <tr> <td>VL1019A0</td> <td>POMPE DETERGENT VIBRATION</td> <td>1.000</td> <td>PCS</td> </tr> <tr> <td>VL1047A1</td> <td>PORTEGOMM E D6-EXTREMIT E D8</td> <td>1.000</td> <td>PCS</td> </tr> <tr> <td>VL1065A1</td> <td>PRESSOSTAT N.O. 1/4 M CIL</td> <td>1.000</td> <td>PCS</td> </tr> <tr> <td>VL1102A1</td> <td>FILTRE DANS LA LIGNE DET+VNR BARBED 6MM</td> <td>1.000</td> <td>PCS</td> </tr> <tr> <td>VL1128A1</td> <td>CLAPET ANTIRETOUR BARBED D6</td> <td>1.000</td> <td>PCS</td> </tr> <tr> <td>VL1166A0</td> <td>RACCORD EN L BB6-AL6</td> <td>4.000</td> <td>PCS</td> </tr> <tr> <td>VL1174C0</td> <td>INJECTEUR ETALLONE D 1.2 MM</td> <td>1.000</td> <td>PCS</td> </tr> <tr> <td>VL1186A0</td> <td>DISTRIBUTEUR LAVAGE PLUS 3 VOIES GICLEUR</td> <td>1.000</td> <td>PCS</td> </tr> <tr> <td>VL1190A0</td> <td>DISTRIBUTEUR ENTREE LAVAGE PLUS</td> <td>1.000</td> <td>PCS</td> </tr> <tr> <td>VL1214A0</td> <td>CLAPET ANTI RETOUR BB6 BAIONETTE</td> <td>1.000</td> <td>PCS</td> </tr> <tr> <td>VM1605A0</td> <td>CLIP TWIST LOCK DIAM. 10,2-12,7 MM</td> <td>3.000</td> <td>PCS</td> </tr> <tr> <td>VM2172A0</td> <td>CLIP BLOCAGE POMPE AVEC CIRCUIT</td> <td>5.000</td> <td>PCS</td> </tr> </tbody> </table>	Code	Description	Qté	UOM	TB3440A0	TB3132A L=1050mm EPDM WHITE-BLUE PIPE	1.000	PCS	TB3614A0		1.000	PCS	VI1220A1	VIS AUTOTARADE UX 4.2x12 TCB MARUTEX PRE	1.000	PCS	VL1019A0	POMPE DETERGENT VIBRATION	1.000	PCS	VL1047A1	PORTEGOMM E D6-EXTREMIT E D8	1.000	PCS	VL1065A1	PRESSOSTAT N.O. 1/4 M CIL	1.000	PCS	VL1102A1	FILTRE DANS LA LIGNE DET+VNR BARBED 6MM	1.000	PCS	VL1128A1	CLAPET ANTIRETOUR BARBED D6	1.000	PCS	VL1166A0	RACCORD EN L BB6-AL6	4.000	PCS	VL1174C0	INJECTEUR ETALLONE D 1.2 MM	1.000	PCS	VL1186A0	DISTRIBUTEUR LAVAGE PLUS 3 VOIES GICLEUR	1.000	PCS	VL1190A0	DISTRIBUTEUR ENTREE LAVAGE PLUS	1.000	PCS	VL1214A0	CLAPET ANTI RETOUR BB6 BAIONETTE	1.000	PCS	VM1605A0	CLIP TWIST LOCK DIAM. 10,2-12,7 MM	3.000	PCS	VM2172A0	CLIP BLOCAGE POMPE AVEC CIRCUIT	5.000	PCS	KVL1183A	KIT SYSTEME LAVAGE PLUS 1 BRAS	<table border="1"> <thead> <tr> <th>Code</th> <th>Description</th> <th>Qté</th> <th>UOM</th> </tr> </thead> <tbody> <tr> <td>0H2354A1</td> <td>TOLE SYSTEME LAVAGE PLUS XEVC-XEVL</td> <td>1.000</td> <td>PCS</td> </tr> </tbody> </table>	Code	Description	Qté	UOM	0H2354A1	TOLE SYSTEME LAVAGE PLUS XEVC-XEVL	1.000	PCS
			Code	Description	Qté	UOM																																																																										
TB3440A0	TB3132A L=1050mm EPDM WHITE-BLUE PIPE	1.000	PCS																																																																													
TB3614A0		1.000	PCS																																																																													
VI1220A1	VIS AUTOTARADE UX 4.2x12 TCB MARUTEX PRE	1.000	PCS																																																																													
VL1019A0	POMPE DETERGENT VIBRATION	1.000	PCS																																																																													
VL1047A1	PORTEGOMM E D6-EXTREMIT E D8	1.000	PCS																																																																													
VL1065A1	PRESSOSTAT N.O. 1/4 M CIL	1.000	PCS																																																																													
VL1102A1	FILTRE DANS LA LIGNE DET+VNR BARBED 6MM	1.000	PCS																																																																													
VL1128A1	CLAPET ANTIRETOUR BARBED D6	1.000	PCS																																																																													
VL1166A0	RACCORD EN L BB6-AL6	4.000	PCS																																																																													
VL1174C0	INJECTEUR ETALLONE D 1.2 MM	1.000	PCS																																																																													
VL1186A0	DISTRIBUTEUR LAVAGE PLUS 3 VOIES GICLEUR	1.000	PCS																																																																													
VL1190A0	DISTRIBUTEUR ENTREE LAVAGE PLUS	1.000	PCS																																																																													
VL1214A0	CLAPET ANTI RETOUR BB6 BAIONETTE	1.000	PCS																																																																													
VM1605A0	CLIP TWIST LOCK DIAM. 10,2-12,7 MM	3.000	PCS																																																																													
VM2172A0	CLIP BLOCAGE POMPE AVEC CIRCUIT	5.000	PCS																																																																													
Code	Description	Qté	UOM																																																																													
0H2354A1	TOLE SYSTEME LAVAGE PLUS XEVC-XEVL	1.000	PCS																																																																													

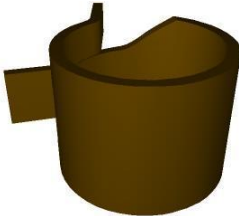
COMPOSANT			PIÈCE DE RECHANGE																																																																																		
Code	Description	Image	Code	Description	Composants du kit																																																																																
0H7820A	SUPPORT LAVAGE PLUS AVEC ELV STEAM		KVL1183A	KIT SYSTEME LAVAGE PLUS 1 BRAS	<table border="1"> <thead> <tr> <th>Code</th> <th>Description</th> <th>Qté</th> <th>UOM</th> </tr> </thead> <tbody> <tr> <td>EL1440A0</td> <td>ELECTROVAN NE H20 AUTONETTOY ANTE BAIONNET</td> <td>3.000</td> <td>PCS</td> </tr> <tr> <td>GN1526A0</td> <td>O-RING D.INT6.9 SP1.8</td> <td>7.000</td> <td>PCS</td> </tr> <tr> <td>RC1018A0</td> <td>COLLIER ELASTIQUE D12 ZINGUE</td> <td>1.000</td> <td>PCS</td> </tr> <tr> <td>RC1019A0</td> <td>COLLIER ELASTIQUE D10 ZINGUE</td> <td>12.000</td> <td>PCS</td> </tr> <tr> <td>RC1130A0</td> <td>COLLIER 130X2.6</td> <td>1.000</td> <td>PCS</td> </tr> <tr> <td>RC1131A0</td> <td>COLLIER 200X2.6 NOIR</td> <td>2.000</td> <td>PCS</td> </tr> <tr> <td>RC1242A0</td> <td>EXTREMITE FERME</td> <td>2.000</td> <td>PCS</td> </tr> <tr> <td>RC1356A0</td> <td>RACCORD DROIT FIL FEMELLE 8X1/4 BSP</td> <td>1.000</td> <td>PCS</td> </tr> <tr> <td>RC1414A1</td> <td>COLLIER A COMPRESSIO N D11.5-12.5</td> <td>1.000</td> <td>PCS</td> </tr> <tr> <td>TB2821A0</td> <td>TB2820A-L=40 MM EPDM NOI</td> <td>4.000</td> <td>PCS</td> </tr> <tr> <td>TB3004A0</td> <td>TB2820A L=550mm EPDM BLACK PIPE</td> <td>1.000</td> <td>PCS</td> </tr> <tr> <td>TB3005B0</td> <td>TB3132A L=550mm EPDM WHITE-BLUE PIPE</td> <td>1.000</td> <td>PCS</td> </tr> <tr> <td>TB3225B0</td> <td>TB2820A-L=67 0MM EPDM NOIR</td> <td>1.000</td> <td>PCS</td> </tr> <tr> <td>TB3252A0</td> <td>TB3252A0</td> <td>1.000</td> <td>PCS</td> </tr> <tr> <td>TB3614A0</td> <td>TB3614A0</td> <td>1.000</td> <td>PCS</td> </tr> <tr> <td>VI1220A1</td> <td>VIS AUTOTARADE UX 4.2x12 TCB MARUTEX PRE</td> <td>1.000</td> <td>PCS</td> </tr> <tr> <td>VL1019A0</td> <td>POMPE DETERGENT VIBRATION</td> <td>1.000</td> <td>PCS</td> </tr> <tr> <td>VL1047A1</td> <td>PORTEGOMME D6-EXTREMIT E D8</td> <td>1.000</td> <td>PCS</td> </tr> <tr> <td>VL1065A1</td> <td>PRESSOSTAT N.O. 1/4 M CIL</td> <td>1.000</td> <td>PCS</td> </tr> </tbody> </table>	Code	Description	Qté	UOM	EL1440A0	ELECTROVAN NE H20 AUTONETTOY ANTE BAIONNET	3.000	PCS	GN1526A0	O-RING D.INT6.9 SP1.8	7.000	PCS	RC1018A0	COLLIER ELASTIQUE D12 ZINGUE	1.000	PCS	RC1019A0	COLLIER ELASTIQUE D10 ZINGUE	12.000	PCS	RC1130A0	COLLIER 130X2.6	1.000	PCS	RC1131A0	COLLIER 200X2.6 NOIR	2.000	PCS	RC1242A0	EXTREMITE FERME	2.000	PCS	RC1356A0	RACCORD DROIT FIL FEMELLE 8X1/4 BSP	1.000	PCS	RC1414A1	COLLIER A COMPRESSIO N D11.5-12.5	1.000	PCS	TB2821A0	TB2820A-L=40 MM EPDM NOI	4.000	PCS	TB3004A0	TB2820A L=550mm EPDM BLACK PIPE	1.000	PCS	TB3005B0	TB3132A L=550mm EPDM WHITE-BLUE PIPE	1.000	PCS	TB3225B0	TB2820A-L=67 0MM EPDM NOIR	1.000	PCS	TB3252A0	TB3252A0	1.000	PCS	TB3614A0	TB3614A0	1.000	PCS	VI1220A1	VIS AUTOTARADE UX 4.2x12 TCB MARUTEX PRE	1.000	PCS	VL1019A0	POMPE DETERGENT VIBRATION	1.000	PCS	VL1047A1	PORTEGOMME D6-EXTREMIT E D8	1.000	PCS	VL1065A1	PRESSOSTAT N.O. 1/4 M CIL	1.000	PCS
Code	Description	Qté	UOM																																																																																		
EL1440A0	ELECTROVAN NE H20 AUTONETTOY ANTE BAIONNET	3.000	PCS																																																																																		
GN1526A0	O-RING D.INT6.9 SP1.8	7.000	PCS																																																																																		
RC1018A0	COLLIER ELASTIQUE D12 ZINGUE	1.000	PCS																																																																																		
RC1019A0	COLLIER ELASTIQUE D10 ZINGUE	12.000	PCS																																																																																		
RC1130A0	COLLIER 130X2.6	1.000	PCS																																																																																		
RC1131A0	COLLIER 200X2.6 NOIR	2.000	PCS																																																																																		
RC1242A0	EXTREMITE FERME	2.000	PCS																																																																																		
RC1356A0	RACCORD DROIT FIL FEMELLE 8X1/4 BSP	1.000	PCS																																																																																		
RC1414A1	COLLIER A COMPRESSIO N D11.5-12.5	1.000	PCS																																																																																		
TB2821A0	TB2820A-L=40 MM EPDM NOI	4.000	PCS																																																																																		
TB3004A0	TB2820A L=550mm EPDM BLACK PIPE	1.000	PCS																																																																																		
TB3005B0	TB3132A L=550mm EPDM WHITE-BLUE PIPE	1.000	PCS																																																																																		
TB3225B0	TB2820A-L=67 0MM EPDM NOIR	1.000	PCS																																																																																		
TB3252A0	TB3252A0	1.000	PCS																																																																																		
TB3614A0	TB3614A0	1.000	PCS																																																																																		
VI1220A1	VIS AUTOTARADE UX 4.2x12 TCB MARUTEX PRE	1.000	PCS																																																																																		
VL1019A0	POMPE DETERGENT VIBRATION	1.000	PCS																																																																																		
VL1047A1	PORTEGOMME D6-EXTREMIT E D8	1.000	PCS																																																																																		
VL1065A1	PRESSOSTAT N.O. 1/4 M CIL	1.000	PCS																																																																																		

COMPOSANT			PIÈCE DE RECHANGE																																										
Code	Description	Image	Code	Description	Composants du kit																																								
0H7820A	SUPPORT LAVAGE PLUS AVEC ELV STEAM		KVL1183A	KIT SYSTEME LAVAGE PLUS 1 BRAS	<table border="1"> <thead> <tr> <th>Code</th> <th>Description</th> <th>Qté</th> <th>UOM</th> </tr> </thead> <tbody> <tr> <td>VL1102A1</td> <td>FILTRE DANS LA LIGNE DET+VNR BARBED 6MM</td> <td>1.000</td> <td>PCS</td> </tr> <tr> <td>VL1128A1</td> <td>CLAPET ANTIRETOUR BARBED D6</td> <td>1.000</td> <td>PCS</td> </tr> <tr> <td>VL1166A0</td> <td>RACCORD EN L BB6-AL6</td> <td>3.000</td> <td>PCS</td> </tr> <tr> <td>VL1174C0</td> <td>INJECTEUR ET ALLONE D 1.2 MM</td> <td>1.000</td> <td>PCS</td> </tr> <tr> <td>VL1185A0</td> <td>DISTRIBUTEUR LAVAGE PLUS 2 VOIES PLUS</td> <td>1.000</td> <td>PCS</td> </tr> <tr> <td>VL1190A0</td> <td>DISTRIBUTEUR ENTREE LAVAGE PLUS</td> <td>1.000</td> <td>PCS</td> </tr> <tr> <td>VL1214A0</td> <td>CLAPET ANTI RETOUR BB6 BAIONETTE</td> <td>1.000</td> <td>PCS</td> </tr> <tr> <td>VM1605A0</td> <td>CLIP TWIST LOCK DIAM. 10,2-12,7 MM</td> <td>3.000</td> <td>PCS</td> </tr> <tr> <td>VM2172A0</td> <td>CLIP BLOCAGE POMPE AVEC CIRCUIT</td> <td>4.000</td> <td>PCS</td> </tr> </tbody> </table>	Code	Description	Qté	UOM	VL1102A1	FILTRE DANS LA LIGNE DET+VNR BARBED 6MM	1.000	PCS	VL1128A1	CLAPET ANTIRETOUR BARBED D6	1.000	PCS	VL1166A0	RACCORD EN L BB6-AL6	3.000	PCS	VL1174C0	INJECTEUR ET ALLONE D 1.2 MM	1.000	PCS	VL1185A0	DISTRIBUTEUR LAVAGE PLUS 2 VOIES PLUS	1.000	PCS	VL1190A0	DISTRIBUTEUR ENTREE LAVAGE PLUS	1.000	PCS	VL1214A0	CLAPET ANTI RETOUR BB6 BAIONETTE	1.000	PCS	VM1605A0	CLIP TWIST LOCK DIAM. 10,2-12,7 MM	3.000	PCS	VM2172A0	CLIP BLOCAGE POMPE AVEC CIRCUIT	4.000	PCS
					Code	Description	Qté	UOM																																					
					VL1102A1	FILTRE DANS LA LIGNE DET+VNR BARBED 6MM	1.000	PCS																																					
					VL1128A1	CLAPET ANTIRETOUR BARBED D6	1.000	PCS																																					
					VL1166A0	RACCORD EN L BB6-AL6	3.000	PCS																																					
					VL1174C0	INJECTEUR ET ALLONE D 1.2 MM	1.000	PCS																																					
					VL1185A0	DISTRIBUTEUR LAVAGE PLUS 2 VOIES PLUS	1.000	PCS																																					
					VL1190A0	DISTRIBUTEUR ENTREE LAVAGE PLUS	1.000	PCS																																					
					VL1214A0	CLAPET ANTI RETOUR BB6 BAIONETTE	1.000	PCS																																					
					VM1605A0	CLIP TWIST LOCK DIAM. 10,2-12,7 MM	3.000	PCS																																					
VM2172A0	CLIP BLOCAGE POMPE AVEC CIRCUIT	4.000	PCS																																										
GN1526A	O-RING D.INT6.9 SP1.8		KGN1526A	KIT 10 PCS O-RING D.INT6.9 SP1.8	<table border="1"> <thead> <tr> <th>Code</th> <th>Description</th> <th>Qté</th> <th>UOM</th> </tr> </thead> <tbody> <tr> <td>GN1526A0</td> <td>O-RING D.INT6.9 SP1.8</td> <td>10.000</td> <td>PCS</td> </tr> </tbody> </table>	Code	Description	Qté	UOM	GN1526A0	O-RING D.INT6.9 SP1.8	10.000	PCS																																
Code	Description	Qté	UOM																																										
GN1526A0	O-RING D.INT6.9 SP1.8	10.000	PCS																																										
RC1019A	COLLIER ELASTIQUE D10 ZINGUE		KRC1019A	KIT COLLIER ELASTIQUE D10 ZINGUEE 15 PCS	<table border="1"> <thead> <tr> <th>Code</th> <th>Description</th> <th>Qté</th> <th>UOM</th> </tr> </thead> <tbody> <tr> <td>RC1019A0</td> <td>COLLIER ELASTIQUE D10 ZINGUE</td> <td>15.000</td> <td>PCS</td> </tr> </tbody> </table>	Code	Description	Qté	UOM	RC1019A0	COLLIER ELASTIQUE D10 ZINGUE	15.000	PCS																																
Code	Description	Qté	UOM																																										
RC1019A0	COLLIER ELASTIQUE D10 ZINGUE	15.000	PCS																																										

COMPOSANT			PIÈCE DE RECHANGE																																										
Code	Description	Image	Code	Description	Composants du kit																																								
RC1242A	EXTREMITE FERME		KRC1242A	KIT 20 PCS EXTREMITE FERMEE D10	<table border="1"> <thead> <tr> <th>Code</th> <th>Description</th> <th>Qté</th> <th>UOM</th> </tr> </thead> <tbody> <tr> <td>RC1242A0</td> <td>EXTREMITE FERME</td> <td>20.000</td> <td>PCS</td> </tr> </tbody> </table>	Code	Description	Qté	UOM	RC1242A0	EXTREMITE FERME	20.000	PCS																																
Code	Description	Qté	UOM																																										
RC1242A0	EXTREMITE FERME	20.000	PCS																																										
RC1356A	RACCORD DROIT FIL FEMELLE 8X1/4 BSP		KRC1356A	KIT RACCORD DROIT FIL.FEM. 8X1/4 BSP	<table border="1"> <thead> <tr> <th>Code</th> <th>Description</th> <th>Qté</th> <th>UOM</th> </tr> </thead> <tbody> <tr> <td>RC1356A0</td> <td>RACCORD DROIT FIL FEMELLE 8X1/4 BSP</td> <td>1.000</td> <td>PCS</td> </tr> </tbody> </table>	Code	Description	Qté	UOM	RC1356A0	RACCORD DROIT FIL FEMELLE 8X1/4 BSP	1.000	PCS																																
Code	Description	Qté	UOM																																										
RC1356A0	RACCORD DROIT FIL FEMELLE 8X1/4 BSP	1.000	PCS																																										
VL1019A	POMPE DETERGENT VIBRATION		KVL2618A	KIT SYSTEME LAVAGE ONE 2 BRA	<table border="1"> <thead> <tr> <th>Code</th> <th>Description</th> <th>Qté</th> <th>UOM</th> </tr> </thead> <tbody> <tr> <td>0H2202A1</td> <td>SYSTEME DE LAVAGE ONE AVEC EL VAPEUR</td> <td>2.000</td> <td>PCS</td> </tr> <tr> <td>CE1030A0</td> <td>FASTON FEMELLE 6.3X0.8 0.5-1 MMQ</td> <td>4.000</td> <td>PCS</td> </tr> <tr> <td>CE1395A0</td> <td>FASTON MALE 6.3X0.8 CUIVRE ETAM</td> <td>2.000</td> <td>PCS</td> </tr> <tr> <td>CE1545A0</td> <td>CABLEUNIP AWG18 ST.3135 BLEU</td> <td>2.000</td> <td>M</td> </tr> <tr> <td>CE1570A0</td> <td>CABLE UNIP AWG18 ST.3135 BLAN</td> <td>2.000</td> <td>M</td> </tr> <tr> <td>CE1660A0</td> <td>COUVERTURE FASTON FEMELLE 6.3X0.8</td> <td>4.000</td> <td>PCS</td> </tr> <tr> <td>CE1661A0</td> <td>COUVERTURE FASTON FEMELLE 6.3X0.8</td> <td>2.000</td> <td>PCS</td> </tr> <tr> <td>EL1020A1</td> <td>RACCORD INTERMEDIAIR E T TUYAU D8 JG</td> <td>1.000</td> <td>PCS</td> </tr> <tr> <td>EL1440A0</td> <td>ELECTROVAN NE H20 AUTONETTOY ANTE BAIONNET</td> <td>2.000</td> <td>PCS</td> </tr> </tbody> </table>	Code	Description	Qté	UOM	0H2202A1	SYSTEME DE LAVAGE ONE AVEC EL VAPEUR	2.000	PCS	CE1030A0	FASTON FEMELLE 6.3X0.8 0.5-1 MMQ	4.000	PCS	CE1395A0	FASTON MALE 6.3X0.8 CUIVRE ETAM	2.000	PCS	CE1545A0	CABLEUNIP AWG18 ST.3135 BLEU	2.000	M	CE1570A0	CABLE UNIP AWG18 ST.3135 BLAN	2.000	M	CE1660A0	COUVERTURE FASTON FEMELLE 6.3X0.8	4.000	PCS	CE1661A0	COUVERTURE FASTON FEMELLE 6.3X0.8	2.000	PCS	EL1020A1	RACCORD INTERMEDIAIR E T TUYAU D8 JG	1.000	PCS	EL1440A0	ELECTROVAN NE H20 AUTONETTOY ANTE BAIONNET	2.000	PCS
Code	Description	Qté	UOM																																										
0H2202A1	SYSTEME DE LAVAGE ONE AVEC EL VAPEUR	2.000	PCS																																										
CE1030A0	FASTON FEMELLE 6.3X0.8 0.5-1 MMQ	4.000	PCS																																										
CE1395A0	FASTON MALE 6.3X0.8 CUIVRE ETAM	2.000	PCS																																										
CE1545A0	CABLEUNIP AWG18 ST.3135 BLEU	2.000	M																																										
CE1570A0	CABLE UNIP AWG18 ST.3135 BLAN	2.000	M																																										
CE1660A0	COUVERTURE FASTON FEMELLE 6.3X0.8	4.000	PCS																																										
CE1661A0	COUVERTURE FASTON FEMELLE 6.3X0.8	2.000	PCS																																										
EL1020A1	RACCORD INTERMEDIAIR E T TUYAU D8 JG	1.000	PCS																																										
EL1440A0	ELECTROVAN NE H20 AUTONETTOY ANTE BAIONNET	2.000	PCS																																										

COMPOSANT			PIÈCE DE RECHANGE																																																																														
Code	Description	Image	Code	Description	Composants du kit																																																																												
VL1019A	POMPE DETERGENT VIBRATION		KVL2618A	KIT SYSTEME LAVAGE ONE 2 BRA	<table border="1"> <thead> <tr> <th>Code</th> <th>Description</th> <th>Qté</th> <th>UOM</th> </tr> </thead> <tbody> <tr> <td>GN1526A0</td> <td>O-RING D.INT6.9 SP1.8</td> <td>6.000</td> <td>PCS</td> </tr> <tr> <td>RC1018A0</td> <td>COLLIER ELASTIQUE D12 ZINGUE</td> <td>2.000</td> <td>PCS</td> </tr> <tr> <td>RC1019A0</td> <td>COLLIER ELASTIQUE D10 ZINGUE</td> <td>28.000</td> <td>PCS</td> </tr> <tr> <td>RC1130A0</td> <td>COLLIER 130X2.6</td> <td>4.000</td> <td>PCS</td> </tr> <tr> <td>RC1242A0</td> <td>EXTREMITÉ FERME</td> <td>4.000</td> <td>PCS</td> </tr> <tr> <td>RC1414A1</td> <td>COLLIER A COMPRESSIO N D11.5-12.5</td> <td>5.000</td> <td>PCS</td> </tr> <tr> <td>TB2821A0</td> <td>TB2820A-L=40 MM EPDM NOI</td> <td>12.000</td> <td>PCS</td> </tr> <tr> <td>TB3004A0</td> <td>TB2820A L=550mm EPDM BLACK PIPE</td> <td>2.000</td> <td>PCS</td> </tr> <tr> <td>TB3009B0</td> <td>TB3132A-ONE OVEN WASHING INLET</td> <td>2.000</td> <td>PCS</td> </tr> <tr> <td>TB3225B0</td> <td>TB2820A-L=67 0MM EPDM NOIR</td> <td>2.000</td> <td>PCS</td> </tr> <tr> <td>VH1220A1</td> <td>VIS AUTOTARADE UX 4.2x12 TCB MARUTEX PRE</td> <td>2.000</td> <td>PCS</td> </tr> <tr> <td>VL1019A0</td> <td>POMPE DETERGENT VIBRATION</td> <td>2.000</td> <td>PCS</td> </tr> <tr> <td>VL1047A1</td> <td>PORTEGOMM E D6-EXTREMIT E D8</td> <td>2.000</td> <td>PCS</td> </tr> <tr> <td>VL1054B0</td> <td>DISTRIBUTEU R ENTREES LAVAGES ONE</td> <td>2.000</td> <td>PCS</td> </tr> <tr> <td>VL1102A1</td> <td>FILTRE DANS LA LIGNE DET+VNR BARBED 6MM</td> <td>2.000</td> <td>PCS</td> </tr> <tr> <td>VL1127A1</td> <td>RACCORD T BARBED 6mm</td> <td>1.000</td> <td>PCS</td> </tr> <tr> <td>VL1128A1</td> <td>CLAPET ANTIRETOUR BARBED D6</td> <td>4.000</td> <td>PCS</td> </tr> <tr> <td>VL1166A0</td> <td>RACCORD EN L BB6-AL6</td> <td>2.000</td> <td>PCS</td> </tr> </tbody> </table>	Code	Description	Qté	UOM	GN1526A0	O-RING D.INT6.9 SP1.8	6.000	PCS	RC1018A0	COLLIER ELASTIQUE D12 ZINGUE	2.000	PCS	RC1019A0	COLLIER ELASTIQUE D10 ZINGUE	28.000	PCS	RC1130A0	COLLIER 130X2.6	4.000	PCS	RC1242A0	EXTREMITÉ FERME	4.000	PCS	RC1414A1	COLLIER A COMPRESSIO N D11.5-12.5	5.000	PCS	TB2821A0	TB2820A-L=40 MM EPDM NOI	12.000	PCS	TB3004A0	TB2820A L=550mm EPDM BLACK PIPE	2.000	PCS	TB3009B0	TB3132A-ONE OVEN WASHING INLET	2.000	PCS	TB3225B0	TB2820A-L=67 0MM EPDM NOIR	2.000	PCS	VH1220A1	VIS AUTOTARADE UX 4.2x12 TCB MARUTEX PRE	2.000	PCS	VL1019A0	POMPE DETERGENT VIBRATION	2.000	PCS	VL1047A1	PORTEGOMM E D6-EXTREMIT E D8	2.000	PCS	VL1054B0	DISTRIBUTEU R ENTREES LAVAGES ONE	2.000	PCS	VL1102A1	FILTRE DANS LA LIGNE DET+VNR BARBED 6MM	2.000	PCS	VL1127A1	RACCORD T BARBED 6mm	1.000	PCS	VL1128A1	CLAPET ANTIRETOUR BARBED D6	4.000	PCS	VL1166A0	RACCORD EN L BB6-AL6	2.000	PCS
					Code	Description	Qté	UOM																																																																									
					GN1526A0	O-RING D.INT6.9 SP1.8	6.000	PCS																																																																									
					RC1018A0	COLLIER ELASTIQUE D12 ZINGUE	2.000	PCS																																																																									
					RC1019A0	COLLIER ELASTIQUE D10 ZINGUE	28.000	PCS																																																																									
					RC1130A0	COLLIER 130X2.6	4.000	PCS																																																																									
					RC1242A0	EXTREMITÉ FERME	4.000	PCS																																																																									
					RC1414A1	COLLIER A COMPRESSIO N D11.5-12.5	5.000	PCS																																																																									
					TB2821A0	TB2820A-L=40 MM EPDM NOI	12.000	PCS																																																																									
					TB3004A0	TB2820A L=550mm EPDM BLACK PIPE	2.000	PCS																																																																									
					TB3009B0	TB3132A-ONE OVEN WASHING INLET	2.000	PCS																																																																									
					TB3225B0	TB2820A-L=67 0MM EPDM NOIR	2.000	PCS																																																																									
					VH1220A1	VIS AUTOTARADE UX 4.2x12 TCB MARUTEX PRE	2.000	PCS																																																																									
					VL1019A0	POMPE DETERGENT VIBRATION	2.000	PCS																																																																									
					VL1047A1	PORTEGOMM E D6-EXTREMIT E D8	2.000	PCS																																																																									
					VL1054B0	DISTRIBUTEU R ENTREES LAVAGES ONE	2.000	PCS																																																																									
					VL1102A1	FILTRE DANS LA LIGNE DET+VNR BARBED 6MM	2.000	PCS																																																																									
					VL1127A1	RACCORD T BARBED 6mm	1.000	PCS																																																																									
					VL1128A1	CLAPET ANTIRETOUR BARBED D6	4.000	PCS																																																																									
					VL1166A0	RACCORD EN L BB6-AL6	2.000	PCS																																																																									

COMPOSANT			PIÈCE DE RECHANGE																																																											
Code	Description	Image	Code	Description	Composants du kit																																																									
VL1019A	POMPE DETERGENT VIBRATION		KVL2618A	KIT SYSTEME LAVAGE ONE 2 BRA	<table border="1"> <thead> <tr> <th>Code</th> <th>Description</th> <th>Qté</th> <th>UOM</th> </tr> </thead> <tbody> <tr> <td>VL1174C0</td> <td>INJECTEUR ETALLONE D 1.2 MM</td> <td>2.000</td> <td>PCS</td> </tr> <tr> <td>VL1191A0</td> <td>DISTRIBUTEUR R SORTIE LAVAGE ONE</td> <td>2.000</td> <td>PCS</td> </tr> <tr> <td>VL1214A0</td> <td>CLAPET ANTI RETOUR BB6 BAIONETTE</td> <td>2.000</td> <td>PCS</td> </tr> <tr> <td>VM2172A0</td> <td>CLIP BLOCAGE POMPE AVEC CIRCUIT</td> <td>4.000</td> <td>PCS</td> </tr> </tbody> </table>	Code	Description	Qté	UOM	VL1174C0	INJECTEUR ETALLONE D 1.2 MM	2.000	PCS	VL1191A0	DISTRIBUTEUR R SORTIE LAVAGE ONE	2.000	PCS	VL1214A0	CLAPET ANTI RETOUR BB6 BAIONETTE	2.000	PCS	VM2172A0	CLIP BLOCAGE POMPE AVEC CIRCUIT	4.000	PCS																																					
			Code	Description	Qté	UOM																																																								
VL1174C0	INJECTEUR ETALLONE D 1.2 MM	2.000	PCS																																																											
VL1191A0	DISTRIBUTEUR R SORTIE LAVAGE ONE	2.000	PCS																																																											
VL1214A0	CLAPET ANTI RETOUR BB6 BAIONETTE	2.000	PCS																																																											
VM2172A0	CLIP BLOCAGE POMPE AVEC CIRCUIT	4.000	PCS																																																											
KVL1225A	KIT SYSTEME DE LAVAGE HOTTE US	<table border="1"> <thead> <tr> <th>Code</th> <th>Description</th> <th>Qté</th> <th>UOM</th> </tr> </thead> <tbody> <tr> <td>0H2213A1</td> <td>TOLE SYSTEME HYDRIQUE HOTTE</td> <td>1.000</td> <td>PCS</td> </tr> <tr> <td>EL1450A0</td> <td>ELECTROVAN NE H2O AUTONETTOY ANTE USA</td> <td>2.000</td> <td>PCS</td> </tr> <tr> <td>GN1526A0</td> <td>O-RING D.INT6.9 SP1.8</td> <td>5.000</td> <td>PCS</td> </tr> <tr> <td>RC1018A0</td> <td>COLLIER ELASTIQUE D12 ZINGUE</td> <td>4.000</td> <td>PCS</td> </tr> <tr> <td>RC1019A0</td> <td>COLLIER ELASTIQUE D10 ZINGUE</td> <td>16.000</td> <td>PCS</td> </tr> <tr> <td>RC1131A0</td> <td>COLLIER 200X2.6 NOIR</td> <td>1.000</td> <td>PCS</td> </tr> <tr> <td>RC1242A0</td> <td>EXTREMITE FERME</td> <td>2.000</td> <td>PCS</td> </tr> <tr> <td>RC1414A1</td> <td>COLLIER A COMPRESSIO N D11.5-12.5</td> <td>4.000</td> <td>PCS</td> </tr> <tr> <td>TB2821A0</td> <td>TB2820A-L=40 MM EPDM NOI</td> <td>6.000</td> <td>PCS</td> </tr> <tr> <td>TB2994A0</td> <td>TB2820A0-TUY AU DETERGENT CAMPANAS 1</td> <td>2.000</td> <td>PCS</td> </tr> <tr> <td>TB3252A0</td> <td>TB3252A0</td> <td>2.000</td> <td>PCS</td> </tr> <tr> <td>VI1220A1</td> <td>VIS AUTOTARADE UX 4.2x12 TCB MARUTEX PRE</td> <td>3.000</td> <td>PCS</td> </tr> <tr> <td>VL1019A0</td> <td>POMPE DETERGENT VIBRATION</td> <td>1.000</td> <td>PCS</td> </tr> <tr> <td>VL1047A1</td> <td>PORTEGOMM E D6-EXTREMIT E D8</td> <td>1.000</td> <td>PCS</td> </tr> </tbody> </table>	Code	Description	Qté	UOM	0H2213A1	TOLE SYSTEME HYDRIQUE HOTTE	1.000	PCS	EL1450A0	ELECTROVAN NE H2O AUTONETTOY ANTE USA	2.000	PCS	GN1526A0	O-RING D.INT6.9 SP1.8	5.000	PCS	RC1018A0	COLLIER ELASTIQUE D12 ZINGUE	4.000	PCS	RC1019A0	COLLIER ELASTIQUE D10 ZINGUE	16.000	PCS	RC1131A0	COLLIER 200X2.6 NOIR	1.000	PCS	RC1242A0	EXTREMITE FERME	2.000	PCS	RC1414A1	COLLIER A COMPRESSIO N D11.5-12.5	4.000	PCS	TB2821A0	TB2820A-L=40 MM EPDM NOI	6.000	PCS	TB2994A0	TB2820A0-TUY AU DETERGENT CAMPANAS 1	2.000	PCS	TB3252A0	TB3252A0	2.000	PCS	VI1220A1	VIS AUTOTARADE UX 4.2x12 TCB MARUTEX PRE	3.000	PCS	VL1019A0	POMPE DETERGENT VIBRATION	1.000	PCS	VL1047A1	PORTEGOMM E D6-EXTREMIT E D8	1.000	PCS
Code	Description	Qté	UOM																																																											
0H2213A1	TOLE SYSTEME HYDRIQUE HOTTE	1.000	PCS																																																											
EL1450A0	ELECTROVAN NE H2O AUTONETTOY ANTE USA	2.000	PCS																																																											
GN1526A0	O-RING D.INT6.9 SP1.8	5.000	PCS																																																											
RC1018A0	COLLIER ELASTIQUE D12 ZINGUE	4.000	PCS																																																											
RC1019A0	COLLIER ELASTIQUE D10 ZINGUE	16.000	PCS																																																											
RC1131A0	COLLIER 200X2.6 NOIR	1.000	PCS																																																											
RC1242A0	EXTREMITE FERME	2.000	PCS																																																											
RC1414A1	COLLIER A COMPRESSIO N D11.5-12.5	4.000	PCS																																																											
TB2821A0	TB2820A-L=40 MM EPDM NOI	6.000	PCS																																																											
TB2994A0	TB2820A0-TUY AU DETERGENT CAMPANAS 1	2.000	PCS																																																											
TB3252A0	TB3252A0	2.000	PCS																																																											
VI1220A1	VIS AUTOTARADE UX 4.2x12 TCB MARUTEX PRE	3.000	PCS																																																											
VL1019A0	POMPE DETERGENT VIBRATION	1.000	PCS																																																											
VL1047A1	PORTEGOMM E D6-EXTREMIT E D8	1.000	PCS																																																											

COMPOSANT			PIÈCE DE RECHANGE																																																		
Code	Description	Image	Code	Description	Composants du kit																																																
VL1019A	POMPE DETERGENT VIBRATION		KVL1225A	KIT SYSTEME DE LAVAGE HOTTE US	<table border="1"> <thead> <tr> <th>Code</th> <th>Description</th> <th>Qté</th> <th>UOM</th> </tr> </thead> <tbody> <tr> <td>VL1054B0</td> <td>DISTRIBUTEUR R ENTREES LAVAGES ONE</td> <td>1.000</td> <td>PCS</td> </tr> <tr> <td>VL1102A1</td> <td>FILTRE DANS LA LIGNE DET+VNR BARBED 6MM</td> <td>1.000</td> <td>PCS</td> </tr> <tr> <td>VL1127A1</td> <td>RACCORD T BARBED 6mm</td> <td>1.000</td> <td>PCS</td> </tr> <tr> <td>VL1128A1</td> <td>CLAPET ANTIRETOUR BARBED D6</td> <td>2.000</td> <td>PCS</td> </tr> <tr> <td>VL1165A0</td> <td>RACCORD DROIT BAM-BB6</td> <td>1.000</td> <td>PCS</td> </tr> <tr> <td>VL1166A0</td> <td>RACCORD EN L BB6-AL6</td> <td>2.000</td> <td>PCS</td> </tr> <tr> <td>VL1174C0</td> <td>INJECTEUR ETALLONE D 1.2 MM</td> <td>1.000</td> <td>PCS</td> </tr> <tr> <td>VL1191A0</td> <td>DISTRIBUTEUR R SORTIE LAVAGE ONE</td> <td>1.000</td> <td>PCS</td> </tr> <tr> <td>VL1214A0</td> <td>CLAPET ANTI RETOUR BB6 BAIONETTE</td> <td>1.000</td> <td>PCS</td> </tr> <tr> <td>VM1605A0</td> <td>CLIP TWIST LOCK DIAM. 10,2-12,7 MM</td> <td>2.000</td> <td>PCS</td> </tr> <tr> <td>VM2172A0</td> <td>CLIP BLOCAGE POMPE AVEC CIRCUIT</td> <td>3.000</td> <td>PCS</td> </tr> </tbody> </table>	Code	Description	Qté	UOM	VL1054B0	DISTRIBUTEUR R ENTREES LAVAGES ONE	1.000	PCS	VL1102A1	FILTRE DANS LA LIGNE DET+VNR BARBED 6MM	1.000	PCS	VL1127A1	RACCORD T BARBED 6mm	1.000	PCS	VL1128A1	CLAPET ANTIRETOUR BARBED D6	2.000	PCS	VL1165A0	RACCORD DROIT BAM-BB6	1.000	PCS	VL1166A0	RACCORD EN L BB6-AL6	2.000	PCS	VL1174C0	INJECTEUR ETALLONE D 1.2 MM	1.000	PCS	VL1191A0	DISTRIBUTEUR R SORTIE LAVAGE ONE	1.000	PCS	VL1214A0	CLAPET ANTI RETOUR BB6 BAIONETTE	1.000	PCS	VM1605A0	CLIP TWIST LOCK DIAM. 10,2-12,7 MM	2.000	PCS	VM2172A0	CLIP BLOCAGE POMPE AVEC CIRCUIT	3.000	PCS
			Code	Description	Qté	UOM																																															
VL1054B0	DISTRIBUTEUR R ENTREES LAVAGES ONE	1.000	PCS																																																		
VL1102A1	FILTRE DANS LA LIGNE DET+VNR BARBED 6MM	1.000	PCS																																																		
VL1127A1	RACCORD T BARBED 6mm	1.000	PCS																																																		
VL1128A1	CLAPET ANTIRETOUR BARBED D6	2.000	PCS																																																		
VL1165A0	RACCORD DROIT BAM-BB6	1.000	PCS																																																		
VL1166A0	RACCORD EN L BB6-AL6	2.000	PCS																																																		
VL1174C0	INJECTEUR ETALLONE D 1.2 MM	1.000	PCS																																																		
VL1191A0	DISTRIBUTEUR R SORTIE LAVAGE ONE	1.000	PCS																																																		
VL1214A0	CLAPET ANTI RETOUR BB6 BAIONETTE	1.000	PCS																																																		
VM1605A0	CLIP TWIST LOCK DIAM. 10,2-12,7 MM	2.000	PCS																																																		
VM2172A0	CLIP BLOCAGE POMPE AVEC CIRCUIT	3.000	PCS																																																		
KVL1222A	KIT SYSTEME LAVAGE ONE PLUS 0311 EU	<table border="1"> <thead> <tr> <th>Code</th> <th>Description</th> <th>Qté</th> <th>UOM</th> </tr> </thead> <tbody> <tr> <td>0H2486A0</td> <td>TOLE SYSTEME LAVAGE 0311</td> <td>1.000</td> <td>PCS</td> </tr> <tr> <td>EL1440A0</td> <td>ELECTROVAN NE H20 AUTONETTOY ANTE BAIONNET</td> <td>1.000</td> <td>PCS</td> </tr> <tr> <td>GN1526A0</td> <td>O-RING D.INT6.9 SP1.8</td> <td>3.000</td> <td>PCS</td> </tr> <tr> <td>RC1018A0</td> <td>COLLIER ELASTIQUE D12 ZINGUE</td> <td>1.000</td> <td>PCS</td> </tr> <tr> <td>RC1019A0</td> <td>COLLIER ELASTIQUE D10 ZINGUE</td> <td>14.000</td> <td>PCS</td> </tr> <tr> <td>RC1242A0</td> <td>EXTREMITÉ FERME</td> <td>2.000</td> <td>PCS</td> </tr> </tbody> </table>	Code	Description	Qté	UOM	0H2486A0	TOLE SYSTEME LAVAGE 0311	1.000	PCS	EL1440A0	ELECTROVAN NE H20 AUTONETTOY ANTE BAIONNET	1.000	PCS	GN1526A0	O-RING D.INT6.9 SP1.8	3.000	PCS	RC1018A0	COLLIER ELASTIQUE D12 ZINGUE	1.000	PCS	RC1019A0	COLLIER ELASTIQUE D10 ZINGUE	14.000	PCS	RC1242A0	EXTREMITÉ FERME	2.000	PCS																							
Code	Description	Qté	UOM																																																		
0H2486A0	TOLE SYSTEME LAVAGE 0311	1.000	PCS																																																		
EL1440A0	ELECTROVAN NE H20 AUTONETTOY ANTE BAIONNET	1.000	PCS																																																		
GN1526A0	O-RING D.INT6.9 SP1.8	3.000	PCS																																																		
RC1018A0	COLLIER ELASTIQUE D12 ZINGUE	1.000	PCS																																																		
RC1019A0	COLLIER ELASTIQUE D10 ZINGUE	14.000	PCS																																																		
RC1242A0	EXTREMITÉ FERME	2.000	PCS																																																		

COMPOSANT			PIÈCE DE RECHANGE																																																																						
Code	Description	Image	Code	Description	Composants du kit																																																																				
VL1019A	POMPE DETERGENT VIBRATION		KVL1222A	KIT SYSTEME LAVAGE ONE PLUS 0311 EU	<table border="1"> <thead> <tr> <th>Code</th> <th>Description</th> <th>Qté</th> <th>UOM</th> </tr> </thead> <tbody> <tr> <td>RC1414A1</td> <td>COLLIER A COMPRESSIO N D11.5-12.5</td> <td>4.000</td> <td>PCS</td> </tr> <tr> <td>TB2821A0</td> <td>TB2820A-L=40 MM EPDM NOI</td> <td>6.000</td> <td>PCS</td> </tr> <tr> <td>TB3004A0</td> <td>TB2820A L=550mm EPDM BLACK PIPE</td> <td>1.000</td> <td>PCS</td> </tr> <tr> <td>TB3009B0</td> <td>TB3132A-ONE OVEN WASHING INLET</td> <td>1.000</td> <td>PCS</td> </tr> <tr> <td>TB3225B0</td> <td>TB2820A-L=67 0MM EPDM NOIR</td> <td>1.000</td> <td>PCS</td> </tr> <tr> <td>VI1220A1</td> <td>VIS AUTOTARADE UX 4.2x12 TCB MARUTEX PRE</td> <td>4.000</td> <td>PCS</td> </tr> <tr> <td>VL1019A0</td> <td>POMPE DETERGENT VIBRATION</td> <td>1.000</td> <td>PCS</td> </tr> <tr> <td>VL1047A1</td> <td>PORTEGOMM E D6-EXTREMIT E D8</td> <td>1.000</td> <td>PCS</td> </tr> <tr> <td>VL1054B0</td> <td>DISTRIBUTEU R ENTREES LAVAGES ONE</td> <td>1.000</td> <td>PCS</td> </tr> <tr> <td>VL1102A1</td> <td>FILTRE DANS LA LIGNE DET+VNR BARBED 6MM</td> <td>1.000</td> <td>PCS</td> </tr> <tr> <td>VL1128A1</td> <td>CLAPET ANTIRETOUR BARBED D6</td> <td>2.000</td> <td>PCS</td> </tr> <tr> <td>VL1166A0</td> <td>RACCORD EN L BB6-AL6</td> <td>1.000</td> <td>PCS</td> </tr> <tr> <td>VL1174C0</td> <td>INJECTEUR ETALLONE D 1.2 MM</td> <td>1.000</td> <td>PCS</td> </tr> <tr> <td>VL1191A0</td> <td>DISTRIBUTEU R SORTIE LAVAGE ONE</td> <td>1.000</td> <td>PCS</td> </tr> <tr> <td>VL1214A0</td> <td>CLAPET ANTI RETOUR BB6 BAIONETTE</td> <td>1.000</td> <td>PCS</td> </tr> <tr> <td>VM2172A0</td> <td>CLIP BLOCAGE POMPE AVEC CIRCUIT</td> <td>2.000</td> <td>PCS</td> </tr> </tbody> </table>	Code	Description	Qté	UOM	RC1414A1	COLLIER A COMPRESSIO N D11.5-12.5	4.000	PCS	TB2821A0	TB2820A-L=40 MM EPDM NOI	6.000	PCS	TB3004A0	TB2820A L=550mm EPDM BLACK PIPE	1.000	PCS	TB3009B0	TB3132A-ONE OVEN WASHING INLET	1.000	PCS	TB3225B0	TB2820A-L=67 0MM EPDM NOIR	1.000	PCS	VI1220A1	VIS AUTOTARADE UX 4.2x12 TCB MARUTEX PRE	4.000	PCS	VL1019A0	POMPE DETERGENT VIBRATION	1.000	PCS	VL1047A1	PORTEGOMM E D6-EXTREMIT E D8	1.000	PCS	VL1054B0	DISTRIBUTEU R ENTREES LAVAGES ONE	1.000	PCS	VL1102A1	FILTRE DANS LA LIGNE DET+VNR BARBED 6MM	1.000	PCS	VL1128A1	CLAPET ANTIRETOUR BARBED D6	2.000	PCS	VL1166A0	RACCORD EN L BB6-AL6	1.000	PCS	VL1174C0	INJECTEUR ETALLONE D 1.2 MM	1.000	PCS	VL1191A0	DISTRIBUTEU R SORTIE LAVAGE ONE	1.000	PCS	VL1214A0	CLAPET ANTI RETOUR BB6 BAIONETTE	1.000	PCS	VM2172A0	CLIP BLOCAGE POMPE AVEC CIRCUIT	2.000	PCS
Code	Description	Qté	UOM																																																																						
RC1414A1	COLLIER A COMPRESSIO N D11.5-12.5	4.000	PCS																																																																						
TB2821A0	TB2820A-L=40 MM EPDM NOI	6.000	PCS																																																																						
TB3004A0	TB2820A L=550mm EPDM BLACK PIPE	1.000	PCS																																																																						
TB3009B0	TB3132A-ONE OVEN WASHING INLET	1.000	PCS																																																																						
TB3225B0	TB2820A-L=67 0MM EPDM NOIR	1.000	PCS																																																																						
VI1220A1	VIS AUTOTARADE UX 4.2x12 TCB MARUTEX PRE	4.000	PCS																																																																						
VL1019A0	POMPE DETERGENT VIBRATION	1.000	PCS																																																																						
VL1047A1	PORTEGOMM E D6-EXTREMIT E D8	1.000	PCS																																																																						
VL1054B0	DISTRIBUTEU R ENTREES LAVAGES ONE	1.000	PCS																																																																						
VL1102A1	FILTRE DANS LA LIGNE DET+VNR BARBED 6MM	1.000	PCS																																																																						
VL1128A1	CLAPET ANTIRETOUR BARBED D6	2.000	PCS																																																																						
VL1166A0	RACCORD EN L BB6-AL6	1.000	PCS																																																																						
VL1174C0	INJECTEUR ETALLONE D 1.2 MM	1.000	PCS																																																																						
VL1191A0	DISTRIBUTEU R SORTIE LAVAGE ONE	1.000	PCS																																																																						
VL1214A0	CLAPET ANTI RETOUR BB6 BAIONETTE	1.000	PCS																																																																						
VM2172A0	CLIP BLOCAGE POMPE AVEC CIRCUIT	2.000	PCS																																																																						

COMPOSANT			PIÈCE DE RECHANGE																																																																																				
Code	Description	Image	Code	Description	Composants du kit																																																																																		
VL1019A	POMPE DETERGENT VIBRATION		KVL1213A	KIT SYSTEME LAVAGE COMPACT PLUS USA	<table border="1"> <thead> <tr> <th>Code</th> <th>Description</th> <th>Qté</th> <th>UOM</th> </tr> </thead> <tbody> <tr> <td>0H2428A2</td> <td>TOLE SYSTEME LAVAGE XECC PLUS</td> <td>1.000</td> <td>PCS</td> </tr> <tr> <td>EL1450A0</td> <td>ELECTROVAN NE H2O AUTONETTOY ANTE USA</td> <td>3.000</td> <td>PCS</td> </tr> <tr> <td>GN1312A0</td> <td>RUBBER CABLE-PASSI NG DE=26 DI=15 SP=10</td> <td>1.000</td> <td>PCS</td> </tr> <tr> <td>GN1526A0</td> <td>O-RING D.INT6.9 SP1.8</td> <td>7.000</td> <td>PCS</td> </tr> <tr> <td>RC1018A0</td> <td>COLLIER ELASTIQUE D12 ZINGUE</td> <td>2.000</td> <td>PCS</td> </tr> <tr> <td>RC1019A0</td> <td>COLLIER ELASTIQUE D10 ZINGUE</td> <td>14.000</td> <td>PCS</td> </tr> <tr> <td>RC1130A0</td> <td>COLLIER 130X2.6</td> <td>1.000</td> <td>PCS</td> </tr> <tr> <td>RC1131A0</td> <td>COLLIER 200X2.6 NOIR</td> <td>1.000</td> <td>PCS</td> </tr> <tr> <td>RC1242A0</td> <td>EXTREMITE FERME</td> <td>2.000</td> <td>PCS</td> </tr> <tr> <td>RC1356A0</td> <td>RACCORD DROIT FIL FEMELLE 8X1/4 BSP</td> <td>1.000</td> <td>PCS</td> </tr> <tr> <td>RC1414A1</td> <td>COLLIER A COMPRESSIO N D11.5-12.5</td> <td>4.000</td> <td>PCS</td> </tr> <tr> <td>TB2821A0</td> <td>TB2820A-L=40 MM EPDM NOI</td> <td>6.000</td> <td>PCS</td> </tr> <tr> <td>TB3004A0</td> <td>TB2820A L=550mm EPDM BLACK PIPE</td> <td>1.000</td> <td>PCS</td> </tr> <tr> <td>TB3005B0</td> <td>TB3132A L=550mm EPDM WHITE-BLUE PIPE</td> <td>1.000</td> <td>PCS</td> </tr> <tr> <td>TB3469A0</td> <td></td> <td>1.000</td> <td>PCS</td> </tr> <tr> <td>VL1019A0</td> <td>POMPE DETERGENT VIBRATION</td> <td></td> <td></td> <td></td> <td>1.000 PCS</td> </tr> <tr> <td>VL1047A1</td> <td>PORTEGOMM E D6-EXTREMIT E D8</td> <td></td> <td></td> <td></td> <td>1.000 PCS</td> </tr> <tr> <td>VL1054B0</td> <td>DISTRIBUTEU R ENTREES LAVAGES ONE</td> <td></td> <td></td> <td></td> <td>1.000 PCS</td> </tr> </tbody> </table>	Code	Description	Qté	UOM	0H2428A2	TOLE SYSTEME LAVAGE XECC PLUS	1.000	PCS	EL1450A0	ELECTROVAN NE H2O AUTONETTOY ANTE USA	3.000	PCS	GN1312A0	RUBBER CABLE-PASSI NG DE=26 DI=15 SP=10	1.000	PCS	GN1526A0	O-RING D.INT6.9 SP1.8	7.000	PCS	RC1018A0	COLLIER ELASTIQUE D12 ZINGUE	2.000	PCS	RC1019A0	COLLIER ELASTIQUE D10 ZINGUE	14.000	PCS	RC1130A0	COLLIER 130X2.6	1.000	PCS	RC1131A0	COLLIER 200X2.6 NOIR	1.000	PCS	RC1242A0	EXTREMITE FERME	2.000	PCS	RC1356A0	RACCORD DROIT FIL FEMELLE 8X1/4 BSP	1.000	PCS	RC1414A1	COLLIER A COMPRESSIO N D11.5-12.5	4.000	PCS	TB2821A0	TB2820A-L=40 MM EPDM NOI	6.000	PCS	TB3004A0	TB2820A L=550mm EPDM BLACK PIPE	1.000	PCS	TB3005B0	TB3132A L=550mm EPDM WHITE-BLUE PIPE	1.000	PCS	TB3469A0		1.000	PCS	VL1019A0	POMPE DETERGENT VIBRATION				1.000 PCS	VL1047A1	PORTEGOMM E D6-EXTREMIT E D8				1.000 PCS	VL1054B0	DISTRIBUTEU R ENTREES LAVAGES ONE				1.000 PCS
Code	Description	Qté	UOM																																																																																				
0H2428A2	TOLE SYSTEME LAVAGE XECC PLUS	1.000	PCS																																																																																				
EL1450A0	ELECTROVAN NE H2O AUTONETTOY ANTE USA	3.000	PCS																																																																																				
GN1312A0	RUBBER CABLE-PASSI NG DE=26 DI=15 SP=10	1.000	PCS																																																																																				
GN1526A0	O-RING D.INT6.9 SP1.8	7.000	PCS																																																																																				
RC1018A0	COLLIER ELASTIQUE D12 ZINGUE	2.000	PCS																																																																																				
RC1019A0	COLLIER ELASTIQUE D10 ZINGUE	14.000	PCS																																																																																				
RC1130A0	COLLIER 130X2.6	1.000	PCS																																																																																				
RC1131A0	COLLIER 200X2.6 NOIR	1.000	PCS																																																																																				
RC1242A0	EXTREMITE FERME	2.000	PCS																																																																																				
RC1356A0	RACCORD DROIT FIL FEMELLE 8X1/4 BSP	1.000	PCS																																																																																				
RC1414A1	COLLIER A COMPRESSIO N D11.5-12.5	4.000	PCS																																																																																				
TB2821A0	TB2820A-L=40 MM EPDM NOI	6.000	PCS																																																																																				
TB3004A0	TB2820A L=550mm EPDM BLACK PIPE	1.000	PCS																																																																																				
TB3005B0	TB3132A L=550mm EPDM WHITE-BLUE PIPE	1.000	PCS																																																																																				
TB3469A0		1.000	PCS																																																																																				
VL1019A0	POMPE DETERGENT VIBRATION				1.000 PCS																																																																																		
VL1047A1	PORTEGOMM E D6-EXTREMIT E D8				1.000 PCS																																																																																		
VL1054B0	DISTRIBUTEU R ENTREES LAVAGES ONE				1.000 PCS																																																																																		

COMPOSANT			PIÈCE DE RECHANGE																																							
Code	Description	Image	Code	Description	Composants du kit																																					
VL1019A	POMPE DETERGENT VIBRATION		KVL1213A	KIT SYSTEME LAVAGE COMPACT PLUS USA	<table border="1"> <thead> <tr> <th>Code</th> <th>Description</th> <th>Qté</th> <th>UOM</th> </tr> </thead> <tbody> <tr> <td>VL1065A1</td> <td>PRESSOSTAT N.O. 1/4 M CIL</td> <td>1.000</td> <td>PCS</td> </tr> <tr> <td>VL1102A1</td> <td>FILTRE DANS LA LIGNE DET+VNR BARBED 6MM</td> <td>1.000</td> <td>PCS</td> </tr> <tr> <td>VL1128A1</td> <td>CLAPET ANTIRETOUR BARBED D6</td> <td>2.000</td> <td>PCS</td> </tr> <tr> <td>VL1165A0</td> <td>RACCORD DROIT BAM-BB6</td> <td>1.000</td> <td>PCS</td> </tr> <tr> <td>VL1166A0</td> <td>RACCORD EN L BB6-AL6</td> <td>3.000</td> <td>PCS</td> </tr> <tr> <td>VL1174C0</td> <td>INJECTEUR ETALLONE D 1.2 MM</td> <td>1.000</td> <td>PCS</td> </tr> <tr> <td>VL1185A0</td> <td>DISTRIBUTEU R LAVAGE PLUS 2 VOIES PLUS</td> <td>1.000</td> <td>PCS</td> </tr> <tr> <td>VM2172A0</td> <td>CLIP BLOCAGE POMPE AVEC CIRCUIT</td> <td>6.000</td> <td>PCS</td> </tr> </tbody> </table>	Code	Description	Qté	UOM	VL1065A1	PRESSOSTAT N.O. 1/4 M CIL	1.000	PCS	VL1102A1	FILTRE DANS LA LIGNE DET+VNR BARBED 6MM	1.000	PCS	VL1128A1	CLAPET ANTIRETOUR BARBED D6	2.000	PCS	VL1165A0	RACCORD DROIT BAM-BB6	1.000	PCS	VL1166A0	RACCORD EN L BB6-AL6	3.000	PCS	VL1174C0	INJECTEUR ETALLONE D 1.2 MM	1.000	PCS	VL1185A0	DISTRIBUTEU R LAVAGE PLUS 2 VOIES PLUS	1.000	PCS	VM2172A0	CLIP BLOCAGE POMPE AVEC CIRCUIT	6.000	PCS	
			Code	Description	Qté	UOM																																				
VL1065A1	PRESSOSTAT N.O. 1/4 M CIL	1.000	PCS																																							
VL1102A1	FILTRE DANS LA LIGNE DET+VNR BARBED 6MM	1.000	PCS																																							
VL1128A1	CLAPET ANTIRETOUR BARBED D6	2.000	PCS																																							
VL1165A0	RACCORD DROIT BAM-BB6	1.000	PCS																																							
VL1166A0	RACCORD EN L BB6-AL6	3.000	PCS																																							
VL1174C0	INJECTEUR ETALLONE D 1.2 MM	1.000	PCS																																							
VL1185A0	DISTRIBUTEU R LAVAGE PLUS 2 VOIES PLUS	1.000	PCS																																							
VM2172A0	CLIP BLOCAGE POMPE AVEC CIRCUIT	6.000	PCS																																							
KVL1212A	KIT SYSTEME LAVAGE PLUS COMPACT EU	<table border="1"> <thead> <tr> <th>Code</th> <th>Description</th> <th>Qté</th> <th>UOM</th> </tr> </thead> <tbody> <tr> <td>0H2428A2</td> <td>TOLE SYSTEME LAVAGE XECC PLUS</td> <td>1.000</td> <td>PCS</td> </tr> <tr> <td>EL1440A0</td> <td>ELECTROVAN NE H20 AUTONETTOY ANTE BAIONNET</td> <td>3.000</td> <td>PCS</td> </tr> <tr> <td>GN1311A0</td> <td>RUBBER CABLE-PASSI NG De=25 Di=12 Th=6,5</td> <td>1.000</td> <td>PCS</td> </tr> <tr> <td>GN1526A0</td> <td>O-RING D.INT6.9 SP1.8</td> <td>7.000</td> <td>PCS</td> </tr> <tr> <td>RC1018A0</td> <td>COLLIER ELASTIQUE D12 ZINGUE</td> <td>5.000</td> <td>PCS</td> </tr> <tr> <td>RC1019A0</td> <td>COLLIER ELASTIQUE D10 ZINGUE</td> <td>14.000</td> <td>PCS</td> </tr> <tr> <td>RC1130A0</td> <td>COLLIER 130X2.6</td> <td>1.000</td> <td>PCS</td> </tr> <tr> <td>RC1131A0</td> <td>COLLIER 200X2.6 NOIR</td> <td>1.000</td> <td>PCS</td> </tr> <tr> <td>RC1242A0</td> <td>EXTREMITE FERME</td> <td>2.000</td> <td>PCS</td> </tr> </tbody> </table>	Code	Description	Qté	UOM	0H2428A2	TOLE SYSTEME LAVAGE XECC PLUS	1.000	PCS	EL1440A0	ELECTROVAN NE H20 AUTONETTOY ANTE BAIONNET	3.000	PCS	GN1311A0	RUBBER CABLE-PASSI NG De=25 Di=12 Th=6,5	1.000	PCS	GN1526A0	O-RING D.INT6.9 SP1.8	7.000	PCS	RC1018A0	COLLIER ELASTIQUE D12 ZINGUE	5.000	PCS	RC1019A0	COLLIER ELASTIQUE D10 ZINGUE	14.000	PCS	RC1130A0	COLLIER 130X2.6	1.000	PCS	RC1131A0	COLLIER 200X2.6 NOIR	1.000	PCS	RC1242A0	EXTREMITE FERME	2.000	PCS
Code	Description	Qté	UOM																																							
0H2428A2	TOLE SYSTEME LAVAGE XECC PLUS	1.000	PCS																																							
EL1440A0	ELECTROVAN NE H20 AUTONETTOY ANTE BAIONNET	3.000	PCS																																							
GN1311A0	RUBBER CABLE-PASSI NG De=25 Di=12 Th=6,5	1.000	PCS																																							
GN1526A0	O-RING D.INT6.9 SP1.8	7.000	PCS																																							
RC1018A0	COLLIER ELASTIQUE D12 ZINGUE	5.000	PCS																																							
RC1019A0	COLLIER ELASTIQUE D10 ZINGUE	14.000	PCS																																							
RC1130A0	COLLIER 130X2.6	1.000	PCS																																							
RC1131A0	COLLIER 200X2.6 NOIR	1.000	PCS																																							
RC1242A0	EXTREMITE FERME	2.000	PCS																																							

COMPOSANT			PIÈCE DE RECHANGE																																																																																								
Code	Description	Image	Code	Description	Composants du kit																																																																																						
VL1019A	POMPE DETERGENT VIBRATION		KVL1212A	KIT SYSTEME LAVAGE PLUS COMPACT EU	<table border="1"> <thead> <tr> <th>Code</th> <th>Description</th> <th>Qté</th> <th>UOM</th> </tr> </thead> <tbody> <tr> <td>RC1356A0</td> <td>RACCORD DROIT FIL FEMELLE 8X1/4 BSP</td> <td>1.000</td> <td>PCS</td> </tr> <tr> <td>RC1414A1</td> <td>COLLIER A COMPRESSIO N D11.5-12.5</td> <td>4.000</td> <td>PCS</td> </tr> <tr> <td>TB2821A0</td> <td>TB2820A-L=40 MM EPDM NOI</td> <td>6.000</td> <td>PCS</td> </tr> <tr> <td>TB3004A0</td> <td>TB2820A L=550mm EPDM BLACK PIPE</td> <td>2.000</td> <td>PCS</td> </tr> <tr> <td>TB3005B0</td> <td>TB3132A L=550mm EPDM WHITE-BLUE PIPE</td> <td>1.000</td> <td>PCS</td> </tr> <tr> <td>TB3252A0</td> <td>TB3252A0</td> <td>1.000</td> <td>PCS</td> </tr> <tr> <td>TB3469A0</td> <td></td> <td>1.000</td> <td>PCS</td> </tr> <tr> <td>VI1220A1</td> <td>VIS AUTOTARADE UX 4.2x12 TCB MARUTEX PRE</td> <td>3.000</td> <td>PCS</td> </tr> <tr> <td>VL1019A0</td> <td>POMPE DETERGENT VIBRATION</td> <td></td> <td>1.000</td> <td>PCS</td> </tr> <tr> <td>VL1047A1</td> <td>PORTEGOMM E D6-EXTREMIT E D8</td> <td></td> <td>1.000</td> <td>PCS</td> </tr> <tr> <td>VL1054B0</td> <td>DISTRIBUTEU R ENTREES LAVAGES ONE</td> <td></td> <td>1.000</td> <td>PCS</td> </tr> <tr> <td>VL1065A1</td> <td>PRESSOSTAT N.O. 1/4 M CIL</td> <td></td> <td>1.000</td> <td>PCS</td> </tr> <tr> <td>VL1102A1</td> <td>FILTRE DANS LA LIGNE DET+VNR BARBED 6MM</td> <td></td> <td>1.000</td> <td>PCS</td> </tr> <tr> <td>VL1127A1</td> <td>RACCORD T BARBED 6mm</td> <td></td> <td>1.000</td> <td>PCS</td> </tr> <tr> <td>VL1128A1</td> <td>CLAPET ANTIRETOUR BARBED D6</td> <td></td> <td>2.000</td> <td>PCS</td> </tr> <tr> <td>VL1165A0</td> <td>RACCORD DROIT BAM-BB6</td> <td></td> <td>1.000</td> <td>PCS</td> </tr> <tr> <td>VL1166A0</td> <td>RACCORD EN L BB6-AL6</td> <td></td> <td>3.000</td> <td>PCS</td> </tr> <tr> <td>VL1174C0</td> <td>INJECTEUR ETALLONE D 1.2 MM</td> <td></td> <td>1.000</td> <td>PCS</td> </tr> </tbody> </table>	Code	Description	Qté	UOM	RC1356A0	RACCORD DROIT FIL FEMELLE 8X1/4 BSP	1.000	PCS	RC1414A1	COLLIER A COMPRESSIO N D11.5-12.5	4.000	PCS	TB2821A0	TB2820A-L=40 MM EPDM NOI	6.000	PCS	TB3004A0	TB2820A L=550mm EPDM BLACK PIPE	2.000	PCS	TB3005B0	TB3132A L=550mm EPDM WHITE-BLUE PIPE	1.000	PCS	TB3252A0	TB3252A0	1.000	PCS	TB3469A0		1.000	PCS	VI1220A1	VIS AUTOTARADE UX 4.2x12 TCB MARUTEX PRE	3.000	PCS	VL1019A0	POMPE DETERGENT VIBRATION		1.000	PCS	VL1047A1	PORTEGOMM E D6-EXTREMIT E D8		1.000	PCS	VL1054B0	DISTRIBUTEU R ENTREES LAVAGES ONE		1.000	PCS	VL1065A1	PRESSOSTAT N.O. 1/4 M CIL		1.000	PCS	VL1102A1	FILTRE DANS LA LIGNE DET+VNR BARBED 6MM		1.000	PCS	VL1127A1	RACCORD T BARBED 6mm		1.000	PCS	VL1128A1	CLAPET ANTIRETOUR BARBED D6		2.000	PCS	VL1165A0	RACCORD DROIT BAM-BB6		1.000	PCS	VL1166A0	RACCORD EN L BB6-AL6		3.000	PCS	VL1174C0	INJECTEUR ETALLONE D 1.2 MM		1.000	PCS
Code	Description	Qté	UOM																																																																																								
RC1356A0	RACCORD DROIT FIL FEMELLE 8X1/4 BSP	1.000	PCS																																																																																								
RC1414A1	COLLIER A COMPRESSIO N D11.5-12.5	4.000	PCS																																																																																								
TB2821A0	TB2820A-L=40 MM EPDM NOI	6.000	PCS																																																																																								
TB3004A0	TB2820A L=550mm EPDM BLACK PIPE	2.000	PCS																																																																																								
TB3005B0	TB3132A L=550mm EPDM WHITE-BLUE PIPE	1.000	PCS																																																																																								
TB3252A0	TB3252A0	1.000	PCS																																																																																								
TB3469A0		1.000	PCS																																																																																								
VI1220A1	VIS AUTOTARADE UX 4.2x12 TCB MARUTEX PRE	3.000	PCS																																																																																								
VL1019A0	POMPE DETERGENT VIBRATION		1.000	PCS																																																																																							
VL1047A1	PORTEGOMM E D6-EXTREMIT E D8		1.000	PCS																																																																																							
VL1054B0	DISTRIBUTEU R ENTREES LAVAGES ONE		1.000	PCS																																																																																							
VL1065A1	PRESSOSTAT N.O. 1/4 M CIL		1.000	PCS																																																																																							
VL1102A1	FILTRE DANS LA LIGNE DET+VNR BARBED 6MM		1.000	PCS																																																																																							
VL1127A1	RACCORD T BARBED 6mm		1.000	PCS																																																																																							
VL1128A1	CLAPET ANTIRETOUR BARBED D6		2.000	PCS																																																																																							
VL1165A0	RACCORD DROIT BAM-BB6		1.000	PCS																																																																																							
VL1166A0	RACCORD EN L BB6-AL6		3.000	PCS																																																																																							
VL1174C0	INJECTEUR ETALLONE D 1.2 MM		1.000	PCS																																																																																							

COMPOSANT			PIÈCE DE RECHANGE																																																															
Code	Description	Image	Code	Description	Composants du kit																																																													
VL1019A	POMPE DETERGENT VIBRATION		KVL1212A	KIT SYSTEME LAVAGE PLUS COMPACT EU	<table border="1"> <thead> <tr> <th>Code</th> <th>Description</th> <th>Qté</th> <th>UOM</th> </tr> </thead> <tbody> <tr> <td>VL1185A0</td> <td>DISTRIBUTEU R LAVAGE PLUS 2 VOIES PLUS</td> <td>1.000</td> <td>PCS</td> </tr> <tr> <td>VM2172A0</td> <td>CLIP BLOCAGE POMPE AVEC CIRCUIT</td> <td>3.000</td> <td>PCS</td> </tr> </tbody> </table>	Code	Description	Qté	UOM	VL1185A0	DISTRIBUTEU R LAVAGE PLUS 2 VOIES PLUS	1.000	PCS	VM2172A0	CLIP BLOCAGE POMPE AVEC CIRCUIT	3.000	PCS																																																	
			Code	Description	Qté	UOM																																																												
VL1185A0	DISTRIBUTEU R LAVAGE PLUS 2 VOIES PLUS	1.000	PCS																																																															
VM2172A0	CLIP BLOCAGE POMPE AVEC CIRCUIT	3.000	PCS																																																															
KVL1211A	KIT SYST. LAVAGE COMPACT ONE ET 0523-EP	<table border="1"> <thead> <tr> <th>Code</th> <th>Description</th> <th>Qté</th> <th>UOM</th> </tr> </thead> <tbody> <tr> <td>0H2427A0</td> <td>XECC WASHING CIRCUIT HOLDING PLATE</td> <td>1.000</td> <td>PCS</td> </tr> <tr> <td>EL1440A0</td> <td>ELECTROVAN NE H2O AUTONETTOY ANTE BAIONNET</td> <td>1.000</td> <td>PCS</td> </tr> <tr> <td>GN1526A0</td> <td>O-RING D.INT6.9 SP1.8</td> <td>3.000</td> <td>PCS</td> </tr> <tr> <td>RC1018A0</td> <td>COLLIER ELASTIQUE D12 ZINGUE</td> <td>4.000</td> <td>PCS</td> </tr> <tr> <td>RC1019A0</td> <td>COLLIER ELASTIQUE D10 ZINGUE</td> <td>14.000</td> <td>PCS</td> </tr> <tr> <td>RC1130A0</td> <td>COLLIER 130X2.6</td> <td>1.000</td> <td>PCS</td> </tr> <tr> <td>RC1242A0</td> <td>EXTREMITE FERME</td> <td>2.000</td> <td>PCS</td> </tr> <tr> <td>RC1414A1</td> <td>COLLIER A COMPRESSIO N D11.5-12.5</td> <td>4.000</td> <td>PCS</td> </tr> <tr> <td>TB2821A0</td> <td>TB2820A-L=40 MM EPDM NOI</td> <td>6.000</td> <td>PCS</td> </tr> <tr> <td>TB3004A0</td> <td>TB2820A L=550mm EPDM BLACK PIPE</td> <td>1.000</td> <td>PCS</td> </tr> <tr> <td>TB3252A0</td> <td>TB3252A0</td> <td>1.000</td> <td>PCS</td> </tr> <tr> <td>TB3469A0</td> <td></td> <td>1.000</td> <td>PCS</td> </tr> <tr> <td>V11220A1</td> <td>VIS AUTOTARADE UX 4.2x12 TCB MARUTEX PRE</td> <td>4.000</td> <td>PCS</td> </tr> <tr> <td>VL1019A0</td> <td>POMPE DETERGENT VIBRATION</td> <td>1.000</td> <td>PCS</td> </tr> <tr> <td>VL1047A1</td> <td>PORTEGOMM E D6-EXTREMIT E D8</td> <td>1.000</td> <td>PCS</td> </tr> </tbody> </table>	Code	Description	Qté	UOM	0H2427A0	XECC WASHING CIRCUIT HOLDING PLATE	1.000	PCS	EL1440A0	ELECTROVAN NE H2O AUTONETTOY ANTE BAIONNET	1.000	PCS	GN1526A0	O-RING D.INT6.9 SP1.8	3.000	PCS	RC1018A0	COLLIER ELASTIQUE D12 ZINGUE	4.000	PCS	RC1019A0	COLLIER ELASTIQUE D10 ZINGUE	14.000	PCS	RC1130A0	COLLIER 130X2.6	1.000	PCS	RC1242A0	EXTREMITE FERME	2.000	PCS	RC1414A1	COLLIER A COMPRESSIO N D11.5-12.5	4.000	PCS	TB2821A0	TB2820A-L=40 MM EPDM NOI	6.000	PCS	TB3004A0	TB2820A L=550mm EPDM BLACK PIPE	1.000	PCS	TB3252A0	TB3252A0	1.000	PCS	TB3469A0		1.000	PCS	V11220A1	VIS AUTOTARADE UX 4.2x12 TCB MARUTEX PRE	4.000	PCS	VL1019A0	POMPE DETERGENT VIBRATION	1.000	PCS	VL1047A1	PORTEGOMM E D6-EXTREMIT E D8	1.000	PCS
Code	Description	Qté	UOM																																																															
0H2427A0	XECC WASHING CIRCUIT HOLDING PLATE	1.000	PCS																																																															
EL1440A0	ELECTROVAN NE H2O AUTONETTOY ANTE BAIONNET	1.000	PCS																																																															
GN1526A0	O-RING D.INT6.9 SP1.8	3.000	PCS																																																															
RC1018A0	COLLIER ELASTIQUE D12 ZINGUE	4.000	PCS																																																															
RC1019A0	COLLIER ELASTIQUE D10 ZINGUE	14.000	PCS																																																															
RC1130A0	COLLIER 130X2.6	1.000	PCS																																																															
RC1242A0	EXTREMITE FERME	2.000	PCS																																																															
RC1414A1	COLLIER A COMPRESSIO N D11.5-12.5	4.000	PCS																																																															
TB2821A0	TB2820A-L=40 MM EPDM NOI	6.000	PCS																																																															
TB3004A0	TB2820A L=550mm EPDM BLACK PIPE	1.000	PCS																																																															
TB3252A0	TB3252A0	1.000	PCS																																																															
TB3469A0		1.000	PCS																																																															
V11220A1	VIS AUTOTARADE UX 4.2x12 TCB MARUTEX PRE	4.000	PCS																																																															
VL1019A0	POMPE DETERGENT VIBRATION	1.000	PCS																																																															
VL1047A1	PORTEGOMM E D6-EXTREMIT E D8	1.000	PCS																																																															

COMPOSANT			PIÈCE DE RECHANGE																																										
Code	Description	Image	Code	Description	Composants du kit																																								
VL1019A	POMPE DETERGENT VIBRATION		KVL1211A	KIT SYST. LAVAGE COMPACT ONE ET 0523-EP	<table border="1"> <thead> <tr> <th>Code</th> <th>Description</th> <th>Qté</th> <th>UOM</th> </tr> </thead> <tbody> <tr> <td>VL1054B0</td> <td>DISTRIBUTEUR R ENTREES LAVAGES ONE</td> <td>1.000</td> <td>PCS</td> </tr> <tr> <td>VL1102A1</td> <td>FILTRE DANS LA LIGNE DET+VNR BARBED 6MM</td> <td>1.000</td> <td>PCS</td> </tr> <tr> <td>VL1127A1</td> <td>RACCORD T BARBED 6mm</td> <td>1.000</td> <td>PCS</td> </tr> <tr> <td>VL1128A1</td> <td>CLAPET ANTIRETOUR BARBED D6</td> <td>2.000</td> <td>PCS</td> </tr> <tr> <td>VL1165A0</td> <td>RACCORD DROIT BAM-BB6</td> <td>1.000</td> <td>PCS</td> </tr> <tr> <td>VL1166A0</td> <td>RACCORD EN L BB6-AL6</td> <td>1.000</td> <td>PCS</td> </tr> <tr> <td>VL1174C0</td> <td>INJECTEUR ETALLONE D 1.2 MM</td> <td>1.000</td> <td>PCS</td> </tr> <tr> <td>VL1191A0</td> <td>DISTRIBUTEUR R SORTIE LAVAGE ONE</td> <td>1.000</td> <td>PCS</td> </tr> <tr> <td>VM2172A0</td> <td>CLIP BLOCAGE POMPE AVEC CIRCUIT</td> <td>2.000</td> <td>PCS</td> </tr> </tbody> </table>	Code	Description	Qté	UOM	VL1054B0	DISTRIBUTEUR R ENTREES LAVAGES ONE	1.000	PCS	VL1102A1	FILTRE DANS LA LIGNE DET+VNR BARBED 6MM	1.000	PCS	VL1127A1	RACCORD T BARBED 6mm	1.000	PCS	VL1128A1	CLAPET ANTIRETOUR BARBED D6	2.000	PCS	VL1165A0	RACCORD DROIT BAM-BB6	1.000	PCS	VL1166A0	RACCORD EN L BB6-AL6	1.000	PCS	VL1174C0	INJECTEUR ETALLONE D 1.2 MM	1.000	PCS	VL1191A0	DISTRIBUTEUR R SORTIE LAVAGE ONE	1.000	PCS	VM2172A0	CLIP BLOCAGE POMPE AVEC CIRCUIT	2.000	PCS
			Code		Description	Qté	UOM																																						
VL1054B0	DISTRIBUTEUR R ENTREES LAVAGES ONE	1.000	PCS																																										
VL1102A1	FILTRE DANS LA LIGNE DET+VNR BARBED 6MM	1.000	PCS																																										
VL1127A1	RACCORD T BARBED 6mm	1.000	PCS																																										
VL1128A1	CLAPET ANTIRETOUR BARBED D6	2.000	PCS																																										
VL1165A0	RACCORD DROIT BAM-BB6	1.000	PCS																																										
VL1166A0	RACCORD EN L BB6-AL6	1.000	PCS																																										
VL1174C0	INJECTEUR ETALLONE D 1.2 MM	1.000	PCS																																										
VL1191A0	DISTRIBUTEUR R SORTIE LAVAGE ONE	1.000	PCS																																										
VM2172A0	CLIP BLOCAGE POMPE AVEC CIRCUIT	2.000	PCS																																										
KVL1209A	KIT SYSTEME DE LAVAGE PLUS 3 TOURN USA	<table border="1"> <thead> <tr> <th>Code</th> <th>Description</th> <th>Qté</th> <th>UOM</th> </tr> </thead> <tbody> <tr> <td>0H2354A1</td> <td>TOLE SYSTEME LAVAGE PLUS XEVC-XEVL</td> <td>1.000</td> <td>PCS</td> </tr> <tr> <td>EL1450A0</td> <td>ELECTROVAN NE H2O AUTONETTOY ANTE USA</td> <td>4.000</td> <td>PCS</td> </tr> <tr> <td>GN1526A0</td> <td>O-RING D.INT6.9 SP1.8</td> <td>9.000</td> <td>PCS</td> </tr> <tr> <td>RC1018A0</td> <td>COLLIER ELASTIQUE D12 ZINGUE</td> <td>11.000</td> <td>PCS</td> </tr> <tr> <td>RC1019A0</td> <td>COLLIER ELASTIQUE D10 ZINGUE</td> <td>14.000</td> <td>PCS</td> </tr> <tr> <td>RC1130A0</td> <td>COLLIER 130X2.6</td> <td>1.000</td> <td>PCS</td> </tr> <tr> <td>RC1131A0</td> <td>COLLIER 200X2.6 NOIR</td> <td>3.000</td> <td>PCS</td> </tr> <tr> <td>RC1242A0</td> <td>EXTREMITÉ FERME</td> <td>2.000</td> <td>PCS</td> </tr> <tr> <td>RC1356A0</td> <td>RACCORD DROIT FIL FEMELLE 8X1/4 BSP</td> <td>1.000</td> <td>PCS</td> </tr> </tbody> </table>	Code	Description	Qté	UOM	0H2354A1	TOLE SYSTEME LAVAGE PLUS XEVC-XEVL	1.000	PCS	EL1450A0	ELECTROVAN NE H2O AUTONETTOY ANTE USA	4.000	PCS	GN1526A0	O-RING D.INT6.9 SP1.8	9.000	PCS	RC1018A0	COLLIER ELASTIQUE D12 ZINGUE	11.000	PCS	RC1019A0	COLLIER ELASTIQUE D10 ZINGUE	14.000	PCS	RC1130A0	COLLIER 130X2.6	1.000	PCS	RC1131A0	COLLIER 200X2.6 NOIR	3.000	PCS	RC1242A0	EXTREMITÉ FERME	2.000	PCS	RC1356A0	RACCORD DROIT FIL FEMELLE 8X1/4 BSP	1.000	PCS			
Code	Description	Qté	UOM																																										
0H2354A1	TOLE SYSTEME LAVAGE PLUS XEVC-XEVL	1.000	PCS																																										
EL1450A0	ELECTROVAN NE H2O AUTONETTOY ANTE USA	4.000	PCS																																										
GN1526A0	O-RING D.INT6.9 SP1.8	9.000	PCS																																										
RC1018A0	COLLIER ELASTIQUE D12 ZINGUE	11.000	PCS																																										
RC1019A0	COLLIER ELASTIQUE D10 ZINGUE	14.000	PCS																																										
RC1130A0	COLLIER 130X2.6	1.000	PCS																																										
RC1131A0	COLLIER 200X2.6 NOIR	3.000	PCS																																										
RC1242A0	EXTREMITÉ FERME	2.000	PCS																																										
RC1356A0	RACCORD DROIT FIL FEMELLE 8X1/4 BSP	1.000	PCS																																										

COMPOSANT			PIÈCE DE RECHANGE																																																																																																
Code	Description	Image	Code	Description	Composants du kit																																																																																														
VL1019A	POMPE DETERGENT VIBRATION		KVL1209A	KIT SYSTEME DE LAVAGE PLUS 3 TOURN USA	<table border="1"> <thead> <tr> <th>Code</th> <th>Description</th> <th>Qté</th> <th>UOM</th> </tr> </thead> <tbody> <tr> <td>RC1414A1</td> <td>COLLIER A COMPRESSIO N D11.5-12.5</td> <td>1.000</td> <td>PCS</td> </tr> <tr> <td>TB2652A0</td> <td></td> <td>1.000</td> <td>PCS</td> </tr> <tr> <td>TB2677A0</td> <td></td> <td>1.000</td> <td>PCS</td> </tr> <tr> <td>TB2821A0</td> <td>TB2820A-L=40 MM EPDM NOI</td> <td>4.000</td> <td>PCS</td> </tr> <tr> <td>TB3004A0</td> <td>TB2820A L=550mm EPDM BLACK PIPE</td> <td>2.000</td> <td>PCS</td> </tr> <tr> <td>TB3024C0</td> <td></td> <td>3.000</td> <td>PCS</td> </tr> <tr> <td>TB3226A0</td> <td></td> <td>1.000</td> <td>PCS</td> </tr> <tr> <td>TB3440A0</td> <td>TB3132A L=1050mm EPDM WHITE-BLUE PIPE</td> <td>1.000</td> <td>PCS</td> </tr> <tr> <td>TB3614A0</td> <td></td> <td>1.000</td> <td>PCS</td> </tr> <tr> <td>VH1220A1</td> <td>VIS AUTOTARADE UX 4.2x12 TCB MARUTEX PRE</td> <td>1.000</td> <td>PCS</td> </tr> <tr> <td>VL1019A0</td> <td>POMPE DETERGENT VIBRATION</td> <td></td> <td>1.000</td> <td>PCS</td> </tr> <tr> <td>VL1065A1</td> <td>PRESSOSTAT N.O. 1/4 M.CIL</td> <td></td> <td>1.000</td> <td>PCS</td> </tr> <tr> <td>VL1102A1</td> <td>FILTRE DANS LA LIGNE DET+VNR BARBED 6MM</td> <td></td> <td>1.000</td> <td>PCS</td> </tr> <tr> <td>VL1127A1</td> <td>RACCORD T BARBED 6mm</td> <td></td> <td>2.000</td> <td>PCS</td> </tr> <tr> <td>VL1128A1</td> <td>CLAPET ANTIRETOUR BARBED D6</td> <td></td> <td>2.000</td> <td>PCS</td> </tr> <tr> <td>VL1166A0</td> <td>RACCORD EN L BB6-AL6</td> <td></td> <td>4.000</td> <td>PCS</td> </tr> <tr> <td>VL1167A2</td> <td>REDUCTEUR DE DEBIT 3 BRAS DE LAVAGE GN21</td> <td></td> <td>1.000</td> <td>PCS</td> </tr> <tr> <td>VL1174C0</td> <td>INJECTEUR ETALLONE D 1.2 MM</td> <td></td> <td>1.000</td> <td>PCS</td> </tr> <tr> <td>VL1186A0</td> <td>DISTRIBUTEU R LAVAGE PLUS 3 VOIES GICLEUR</td> <td></td> <td>1.000</td> <td>PCS</td> </tr> <tr> <td>VL1190A0</td> <td>DISTRIBUTEU R ENTREE LAVAGE PLUS</td> <td></td> <td>1.000</td> <td>PCS</td> </tr> </tbody> </table>	Code	Description	Qté	UOM	RC1414A1	COLLIER A COMPRESSIO N D11.5-12.5	1.000	PCS	TB2652A0		1.000	PCS	TB2677A0		1.000	PCS	TB2821A0	TB2820A-L=40 MM EPDM NOI	4.000	PCS	TB3004A0	TB2820A L=550mm EPDM BLACK PIPE	2.000	PCS	TB3024C0		3.000	PCS	TB3226A0		1.000	PCS	TB3440A0	TB3132A L=1050mm EPDM WHITE-BLUE PIPE	1.000	PCS	TB3614A0		1.000	PCS	VH1220A1	VIS AUTOTARADE UX 4.2x12 TCB MARUTEX PRE	1.000	PCS	VL1019A0	POMPE DETERGENT VIBRATION		1.000	PCS	VL1065A1	PRESSOSTAT N.O. 1/4 M.CIL		1.000	PCS	VL1102A1	FILTRE DANS LA LIGNE DET+VNR BARBED 6MM		1.000	PCS	VL1127A1	RACCORD T BARBED 6mm		2.000	PCS	VL1128A1	CLAPET ANTIRETOUR BARBED D6		2.000	PCS	VL1166A0	RACCORD EN L BB6-AL6		4.000	PCS	VL1167A2	REDUCTEUR DE DEBIT 3 BRAS DE LAVAGE GN21		1.000	PCS	VL1174C0	INJECTEUR ETALLONE D 1.2 MM		1.000	PCS	VL1186A0	DISTRIBUTEU R LAVAGE PLUS 3 VOIES GICLEUR		1.000	PCS	VL1190A0	DISTRIBUTEU R ENTREE LAVAGE PLUS		1.000	PCS
Code	Description	Qté	UOM																																																																																																
RC1414A1	COLLIER A COMPRESSIO N D11.5-12.5	1.000	PCS																																																																																																
TB2652A0		1.000	PCS																																																																																																
TB2677A0		1.000	PCS																																																																																																
TB2821A0	TB2820A-L=40 MM EPDM NOI	4.000	PCS																																																																																																
TB3004A0	TB2820A L=550mm EPDM BLACK PIPE	2.000	PCS																																																																																																
TB3024C0		3.000	PCS																																																																																																
TB3226A0		1.000	PCS																																																																																																
TB3440A0	TB3132A L=1050mm EPDM WHITE-BLUE PIPE	1.000	PCS																																																																																																
TB3614A0		1.000	PCS																																																																																																
VH1220A1	VIS AUTOTARADE UX 4.2x12 TCB MARUTEX PRE	1.000	PCS																																																																																																
VL1019A0	POMPE DETERGENT VIBRATION		1.000	PCS																																																																																															
VL1065A1	PRESSOSTAT N.O. 1/4 M.CIL		1.000	PCS																																																																																															
VL1102A1	FILTRE DANS LA LIGNE DET+VNR BARBED 6MM		1.000	PCS																																																																																															
VL1127A1	RACCORD T BARBED 6mm		2.000	PCS																																																																																															
VL1128A1	CLAPET ANTIRETOUR BARBED D6		2.000	PCS																																																																																															
VL1166A0	RACCORD EN L BB6-AL6		4.000	PCS																																																																																															
VL1167A2	REDUCTEUR DE DEBIT 3 BRAS DE LAVAGE GN21		1.000	PCS																																																																																															
VL1174C0	INJECTEUR ETALLONE D 1.2 MM		1.000	PCS																																																																																															
VL1186A0	DISTRIBUTEU R LAVAGE PLUS 3 VOIES GICLEUR		1.000	PCS																																																																																															
VL1190A0	DISTRIBUTEU R ENTREE LAVAGE PLUS		1.000	PCS																																																																																															

COMPOSANT			PIÈCE DE RECHANGE																																																											
Code	Description	Image	Code	Description	Composants du kit																																																									
VL1019A	POMPE DETERGENT VIBRATION		KVL1209A	KIT SYSTEME DE LAVAGE PLUS 3 TOURN USA	<table border="1"> <thead> <tr> <th>Code</th> <th>Description</th> <th>Qté</th> <th>UOM</th> </tr> </thead> <tbody> <tr> <td>VL1214A0</td> <td>CLAPET ANTI RETOUR BB6 BAIONETTE</td> <td>1.000</td> <td>PCS</td> </tr> <tr> <td>VM1605A0</td> <td>CLIP TWIST LOCK DIAM. 10,2-12,7 MM</td> <td>3.000</td> <td>PCS</td> </tr> <tr> <td>VM2172A0</td> <td>CLIP BLOCAGE POMPE AVEC CIRCUIT</td> <td>5.000</td> <td>PCS</td> </tr> </tbody> </table>	Code	Description	Qté	UOM	VL1214A0	CLAPET ANTI RETOUR BB6 BAIONETTE	1.000	PCS	VM1605A0	CLIP TWIST LOCK DIAM. 10,2-12,7 MM	3.000	PCS	VM2172A0	CLIP BLOCAGE POMPE AVEC CIRCUIT	5.000	PCS																																									
			Code	Description	Qté	UOM																																																								
VL1214A0	CLAPET ANTI RETOUR BB6 BAIONETTE	1.000	PCS																																																											
VM1605A0	CLIP TWIST LOCK DIAM. 10,2-12,7 MM	3.000	PCS																																																											
VM2172A0	CLIP BLOCAGE POMPE AVEC CIRCUIT	5.000	PCS																																																											
KVL1208A	KIT SYSTEME DE LAVAGE PLUS 2 TOURN USA	<table border="1"> <thead> <tr> <th>Code</th> <th>Description</th> <th>Qté</th> <th>UOM</th> </tr> </thead> <tbody> <tr> <td>0H2354A1</td> <td>TOLE SYSTEME LAVAGE PLUS XEVC-XEVL</td> <td>1.000</td> <td>PCS</td> </tr> <tr> <td>EL1450A0</td> <td>ELECTROVAN NE H2O AUTONETTOY ANTE USA</td> <td>4.000</td> <td>PCS</td> </tr> <tr> <td>GN1526A0</td> <td>O-RING D.INT6.9 SP1.8</td> <td>9.000</td> <td>PCS</td> </tr> <tr> <td>RC1018A0</td> <td>COLLIER ELASTIQUE D12 ZINGUE</td> <td>3.000</td> <td>PCS</td> </tr> <tr> <td>RC1019A0</td> <td>COLLIER ELASTIQUE D10 ZINGUE</td> <td>2.000</td> <td>PCS</td> </tr> <tr> <td>RC1130A0</td> <td>COLLIER 130X2.6</td> <td>1.000</td> <td>PCS</td> </tr> <tr> <td>RC1131A0</td> <td>COLLIER 200X2.6 NOIR</td> <td>3.000</td> <td>PCS</td> </tr> <tr> <td>RC1242A0</td> <td>EXTREMITE FERME</td> <td>2.000</td> <td>PCS</td> </tr> <tr> <td>RC1356A0</td> <td>RACCORD DROIT FIL FEMELLE 8X1/4 BSP</td> <td>1.000</td> <td>PCS</td> </tr> <tr> <td>RC1414A1</td> <td>COLLIER A COMPRESSIO N D11.5-12.5</td> <td>4.000</td> <td>PCS</td> </tr> <tr> <td>TB2821A0</td> <td>TB2820A-L=40 MM EPDM NOI</td> <td>6.000</td> <td>PCS</td> </tr> <tr> <td>TB2994A0</td> <td>TB2820A0-TUY AU DETERGENT CAMPANAS 1</td> <td>1.000</td> <td>PCS</td> </tr> <tr> <td>TB3004A0</td> <td>TB2820A L=550mm EPDM BLACK PIPE</td> <td>1.000</td> <td>PCS</td> </tr> <tr> <td>TB3005B0</td> <td>TB3132A L=550mm EPDM WHITE-BLUE PIPE</td> <td>1.000</td> <td>PCS</td> </tr> </tbody> </table>	Code	Description	Qté	UOM	0H2354A1	TOLE SYSTEME LAVAGE PLUS XEVC-XEVL	1.000	PCS	EL1450A0	ELECTROVAN NE H2O AUTONETTOY ANTE USA	4.000	PCS	GN1526A0	O-RING D.INT6.9 SP1.8	9.000	PCS	RC1018A0	COLLIER ELASTIQUE D12 ZINGUE	3.000	PCS	RC1019A0	COLLIER ELASTIQUE D10 ZINGUE	2.000	PCS	RC1130A0	COLLIER 130X2.6	1.000	PCS	RC1131A0	COLLIER 200X2.6 NOIR	3.000	PCS	RC1242A0	EXTREMITE FERME	2.000	PCS	RC1356A0	RACCORD DROIT FIL FEMELLE 8X1/4 BSP	1.000	PCS	RC1414A1	COLLIER A COMPRESSIO N D11.5-12.5	4.000	PCS	TB2821A0	TB2820A-L=40 MM EPDM NOI	6.000	PCS	TB2994A0	TB2820A0-TUY AU DETERGENT CAMPANAS 1	1.000	PCS	TB3004A0	TB2820A L=550mm EPDM BLACK PIPE	1.000	PCS	TB3005B0	TB3132A L=550mm EPDM WHITE-BLUE PIPE	1.000	PCS
Code	Description	Qté	UOM																																																											
0H2354A1	TOLE SYSTEME LAVAGE PLUS XEVC-XEVL	1.000	PCS																																																											
EL1450A0	ELECTROVAN NE H2O AUTONETTOY ANTE USA	4.000	PCS																																																											
GN1526A0	O-RING D.INT6.9 SP1.8	9.000	PCS																																																											
RC1018A0	COLLIER ELASTIQUE D12 ZINGUE	3.000	PCS																																																											
RC1019A0	COLLIER ELASTIQUE D10 ZINGUE	2.000	PCS																																																											
RC1130A0	COLLIER 130X2.6	1.000	PCS																																																											
RC1131A0	COLLIER 200X2.6 NOIR	3.000	PCS																																																											
RC1242A0	EXTREMITE FERME	2.000	PCS																																																											
RC1356A0	RACCORD DROIT FIL FEMELLE 8X1/4 BSP	1.000	PCS																																																											
RC1414A1	COLLIER A COMPRESSIO N D11.5-12.5	4.000	PCS																																																											
TB2821A0	TB2820A-L=40 MM EPDM NOI	6.000	PCS																																																											
TB2994A0	TB2820A0-TUY AU DETERGENT CAMPANAS 1	1.000	PCS																																																											
TB3004A0	TB2820A L=550mm EPDM BLACK PIPE	1.000	PCS																																																											
TB3005B0	TB3132A L=550mm EPDM WHITE-BLUE PIPE	1.000	PCS																																																											

COMPOSANT			PIÈCE DE RECHANGE																																																																													
Code	Description	Image	Code	Description	Composants du kit																																																																											
VL1019A	POMPE DETERGENT VIBRATION		KVL1208A	KIT SYSTEME DE LAVAGE PLUS 2 TOURN USA	<table border="1"> <thead> <tr> <th>Code</th> <th>Description</th> <th>Qté</th> <th>UOM</th> </tr> </thead> <tbody> <tr> <td>TB3440A0</td> <td>TB3132A L=1050mm EPDM WHITE-BLUE PIPE</td> <td>1.000</td> <td>PCS</td> </tr> <tr> <td>VL1019A0</td> <td>POMPE DETERGENT VIBRATION</td> <td>1.000</td> <td>PCS</td> </tr> <tr> <td>VL1047A1</td> <td>PORTEGOMM E D6-EXTREMIT E D8</td> <td>1.000</td> <td>PCS</td> </tr> <tr> <td>VL1065A1</td> <td>PRESSOSTAT N.O. 1/4 M CIL</td> <td>1.000</td> <td>PCS</td> </tr> <tr> <td>VL1102A1</td> <td>FILTRE DANS LA LIGNE DET+VNR BARBED 6MM</td> <td>1.000</td> <td>PCS</td> </tr> <tr> <td>VL1128A1</td> <td>CLAPET ANTIRETOUR BARBED D6</td> <td>2.000</td> <td>PCS</td> </tr> <tr> <td>VL1141A1</td> <td>RACCORD DROIT BB6-BB</td> <td>1.000</td> <td>PCS</td> </tr> <tr> <td>VL1166A0</td> <td>RACCORD EN L BB6-AL6</td> <td>4.000</td> <td>PCS</td> </tr> <tr> <td>VL1174C0</td> <td>INJECTEUR ETALLONE D 1.2 MM</td> <td>1.000</td> <td>PCS</td> </tr> <tr> <td>VL1186A0</td> <td>DISTRIBUTEU R LAVAGE PLUS 3 VOIES GICLEUR</td> <td>1.000</td> <td>PCS</td> </tr> <tr> <td>VL1190A0</td> <td>DISTRIBUTEU R ENTREE LAVAGE PLUS</td> <td>1.000</td> <td>PCS</td> </tr> <tr> <td>VL1214A0</td> <td>CLAPET ANTI RETOUR BB6 BAIONETTE</td> <td>1.000</td> <td>PCS</td> </tr> <tr> <td>VM1605A0</td> <td>CLIP TWIST LOCK DIAM. 10,2-12,7 MM</td> <td>3.000</td> <td>PCS</td> </tr> <tr> <td>VM2172A0</td> <td>CLIP BLOCAGE POMPE AVEC CIRCUIT</td> <td>5.000</td> <td>PCS</td> </tr> </tbody> </table>	Code	Description	Qté	UOM	TB3440A0	TB3132A L=1050mm EPDM WHITE-BLUE PIPE	1.000	PCS	VL1019A0	POMPE DETERGENT VIBRATION	1.000	PCS	VL1047A1	PORTEGOMM E D6-EXTREMIT E D8	1.000	PCS	VL1065A1	PRESSOSTAT N.O. 1/4 M CIL	1.000	PCS	VL1102A1	FILTRE DANS LA LIGNE DET+VNR BARBED 6MM	1.000	PCS	VL1128A1	CLAPET ANTIRETOUR BARBED D6	2.000	PCS	VL1141A1	RACCORD DROIT BB6-BB	1.000	PCS	VL1166A0	RACCORD EN L BB6-AL6	4.000	PCS	VL1174C0	INJECTEUR ETALLONE D 1.2 MM	1.000	PCS	VL1186A0	DISTRIBUTEU R LAVAGE PLUS 3 VOIES GICLEUR	1.000	PCS	VL1190A0	DISTRIBUTEU R ENTREE LAVAGE PLUS	1.000	PCS	VL1214A0	CLAPET ANTI RETOUR BB6 BAIONETTE	1.000	PCS	VM1605A0	CLIP TWIST LOCK DIAM. 10,2-12,7 MM	3.000	PCS	VM2172A0	CLIP BLOCAGE POMPE AVEC CIRCUIT	5.000	PCS	KVL1207A	KIT SYSTEME LAVAGE PLUS 1 TURBINE USA	<table border="1"> <thead> <tr> <th>Code</th> <th>Description</th> <th>Qté</th> <th>UOM</th> </tr> </thead> <tbody> <tr> <td>0H2354A1</td> <td>TOLE SYSTEME LAVAGE PLUS XEVC-XEVL</td> <td>1.000</td> <td>PCS</td> </tr> <tr> <td>EL1450A0</td> <td>ELECTROVAN NE H2O AUTONETTOY ANTE USA</td> <td>3.000</td> <td>PCS</td> </tr> </tbody> </table>	Code	Description	Qté	UOM	0H2354A1	TOLE SYSTEME LAVAGE PLUS XEVC-XEVL	1.000	PCS	EL1450A0	ELECTROVAN NE H2O AUTONETTOY ANTE USA	3.000	PCS
			Code		Description	Qté	UOM																																																																									
TB3440A0	TB3132A L=1050mm EPDM WHITE-BLUE PIPE	1.000	PCS																																																																													
VL1019A0	POMPE DETERGENT VIBRATION	1.000	PCS																																																																													
VL1047A1	PORTEGOMM E D6-EXTREMIT E D8	1.000	PCS																																																																													
VL1065A1	PRESSOSTAT N.O. 1/4 M CIL	1.000	PCS																																																																													
VL1102A1	FILTRE DANS LA LIGNE DET+VNR BARBED 6MM	1.000	PCS																																																																													
VL1128A1	CLAPET ANTIRETOUR BARBED D6	2.000	PCS																																																																													
VL1141A1	RACCORD DROIT BB6-BB	1.000	PCS																																																																													
VL1166A0	RACCORD EN L BB6-AL6	4.000	PCS																																																																													
VL1174C0	INJECTEUR ETALLONE D 1.2 MM	1.000	PCS																																																																													
VL1186A0	DISTRIBUTEU R LAVAGE PLUS 3 VOIES GICLEUR	1.000	PCS																																																																													
VL1190A0	DISTRIBUTEU R ENTREE LAVAGE PLUS	1.000	PCS																																																																													
VL1214A0	CLAPET ANTI RETOUR BB6 BAIONETTE	1.000	PCS																																																																													
VM1605A0	CLIP TWIST LOCK DIAM. 10,2-12,7 MM	3.000	PCS																																																																													
VM2172A0	CLIP BLOCAGE POMPE AVEC CIRCUIT	5.000	PCS																																																																													
Code	Description	Qté	UOM																																																																													
0H2354A1	TOLE SYSTEME LAVAGE PLUS XEVC-XEVL	1.000	PCS																																																																													
EL1450A0	ELECTROVAN NE H2O AUTONETTOY ANTE USA	3.000	PCS																																																																													

COMPOSANT			PIÈCE DE RECHANGE																																																																																										
Code	Description	Image	Code	Description	Composants du kit																																																																																								
VL1019A	POMPE DETERGENT VIBRATION		KVL1207A	KIT SYSTEME LAVAGE PLUS 1 TURBINE USA	<table border="1"> <thead> <tr> <th>Code</th> <th>Description</th> <th>Qté</th> <th>UOM</th> </tr> </thead> <tbody> <tr> <td>GN1526A0</td> <td>O-RING D.INT6.9 SP1.8</td> <td>7.000</td> <td>PCS</td> </tr> <tr> <td>RC1018A0</td> <td>COLLIER ELASTIQUE D12 ZINGUE</td> <td>1.000</td> <td>PCS</td> </tr> <tr> <td>RC1019A0</td> <td>COLLIER ELASTIQUE D10 ZINGUE</td> <td>12.000</td> <td>PCS</td> </tr> <tr> <td>RC1130A0</td> <td>COLLIER 130X2.6</td> <td>1.000</td> <td>PCS</td> </tr> <tr> <td>RC1131A0</td> <td>COLLIER 200X2.6 NOIR</td> <td>2.000</td> <td>PCS</td> </tr> <tr> <td>RC1242A0</td> <td>EXTREMITE FERME</td> <td>2.000</td> <td>PCS</td> </tr> <tr> <td>RC1356A0</td> <td>RACCORD DROIT FIL FEMELLE 8X1/4 BSP</td> <td>1.000</td> <td>PCS</td> </tr> <tr> <td>RC1414A1</td> <td>COLLIER A COMPRESSIO N D11.5-12.5</td> <td>5.000</td> <td>PCS</td> </tr> <tr> <td>TB2821A0</td> <td>TB2820A-L=40 MM EPDM NOI</td> <td>4.000</td> <td>PCS</td> </tr> <tr> <td>TB3004A0</td> <td>TB2820A L=550mm EPDM BLACK PIPE</td> <td>1.000</td> <td>PCS</td> </tr> <tr> <td>TB3005B0</td> <td>TB3132A L=550mm EPDM WHITE-BLUE PIPE</td> <td>2.000</td> <td>PCS</td> </tr> <tr> <td>TB3024C0</td> <td></td> <td>1.000</td> <td>PCS</td> </tr> <tr> <td>TB3225B0</td> <td>TB2820A-L=67 0MM EPDM NOIR</td> <td>1.000</td> <td>PCS</td> </tr> <tr> <td>TB3252A0</td> <td>TB3252A0</td> <td>1.000</td> <td>PCS</td> </tr> <tr> <td>TB3614A0</td> <td></td> <td>1.000</td> <td>PCS</td> </tr> <tr> <td>VI1220A1</td> <td>VIS AUTOTARADE UX 4.2x12 TCB MARUTEX PRE</td> <td>1.000</td> <td>PCS</td> </tr> <tr> <td>VL1019A0</td> <td>POMPE DETERGENT VIBRATION</td> <td></td> <td>1.000</td> <td>PCS</td> </tr> <tr> <td>VL1047A1</td> <td>PORTEGOMM E D6-EXTREMIT E D8</td> <td></td> <td>1.000</td> <td>PCS</td> </tr> <tr> <td>VL1102A1</td> <td>FILTRE DANS LA LIGNE DET+VNR BARBED 6MM</td> <td></td> <td>1.000</td> <td>PCS</td> </tr> <tr> <td>VL1127A1</td> <td>RACCORD T BARBED 6mm</td> <td></td> <td>1.000</td> <td>PCS</td> </tr> </tbody> </table>	Code	Description	Qté	UOM	GN1526A0	O-RING D.INT6.9 SP1.8	7.000	PCS	RC1018A0	COLLIER ELASTIQUE D12 ZINGUE	1.000	PCS	RC1019A0	COLLIER ELASTIQUE D10 ZINGUE	12.000	PCS	RC1130A0	COLLIER 130X2.6	1.000	PCS	RC1131A0	COLLIER 200X2.6 NOIR	2.000	PCS	RC1242A0	EXTREMITE FERME	2.000	PCS	RC1356A0	RACCORD DROIT FIL FEMELLE 8X1/4 BSP	1.000	PCS	RC1414A1	COLLIER A COMPRESSIO N D11.5-12.5	5.000	PCS	TB2821A0	TB2820A-L=40 MM EPDM NOI	4.000	PCS	TB3004A0	TB2820A L=550mm EPDM BLACK PIPE	1.000	PCS	TB3005B0	TB3132A L=550mm EPDM WHITE-BLUE PIPE	2.000	PCS	TB3024C0		1.000	PCS	TB3225B0	TB2820A-L=67 0MM EPDM NOIR	1.000	PCS	TB3252A0	TB3252A0	1.000	PCS	TB3614A0		1.000	PCS	VI1220A1	VIS AUTOTARADE UX 4.2x12 TCB MARUTEX PRE	1.000	PCS	VL1019A0	POMPE DETERGENT VIBRATION		1.000	PCS	VL1047A1	PORTEGOMM E D6-EXTREMIT E D8		1.000	PCS	VL1102A1	FILTRE DANS LA LIGNE DET+VNR BARBED 6MM		1.000	PCS	VL1127A1	RACCORD T BARBED 6mm		1.000	PCS
Code	Description	Qté	UOM																																																																																										
GN1526A0	O-RING D.INT6.9 SP1.8	7.000	PCS																																																																																										
RC1018A0	COLLIER ELASTIQUE D12 ZINGUE	1.000	PCS																																																																																										
RC1019A0	COLLIER ELASTIQUE D10 ZINGUE	12.000	PCS																																																																																										
RC1130A0	COLLIER 130X2.6	1.000	PCS																																																																																										
RC1131A0	COLLIER 200X2.6 NOIR	2.000	PCS																																																																																										
RC1242A0	EXTREMITE FERME	2.000	PCS																																																																																										
RC1356A0	RACCORD DROIT FIL FEMELLE 8X1/4 BSP	1.000	PCS																																																																																										
RC1414A1	COLLIER A COMPRESSIO N D11.5-12.5	5.000	PCS																																																																																										
TB2821A0	TB2820A-L=40 MM EPDM NOI	4.000	PCS																																																																																										
TB3004A0	TB2820A L=550mm EPDM BLACK PIPE	1.000	PCS																																																																																										
TB3005B0	TB3132A L=550mm EPDM WHITE-BLUE PIPE	2.000	PCS																																																																																										
TB3024C0		1.000	PCS																																																																																										
TB3225B0	TB2820A-L=67 0MM EPDM NOIR	1.000	PCS																																																																																										
TB3252A0	TB3252A0	1.000	PCS																																																																																										
TB3614A0		1.000	PCS																																																																																										
VI1220A1	VIS AUTOTARADE UX 4.2x12 TCB MARUTEX PRE	1.000	PCS																																																																																										
VL1019A0	POMPE DETERGENT VIBRATION		1.000	PCS																																																																																									
VL1047A1	PORTEGOMM E D6-EXTREMIT E D8		1.000	PCS																																																																																									
VL1102A1	FILTRE DANS LA LIGNE DET+VNR BARBED 6MM		1.000	PCS																																																																																									
VL1127A1	RACCORD T BARBED 6mm		1.000	PCS																																																																																									

COMPOSANT			PIÈCE DE RECHANGE																																										
Code	Description	Image	Code	Description	Composants du kit																																								
VL1019A	POMPE DETERGENT VIBRATION		KVL1207A	KIT SYSTEME LAVAGE PLUS 1 TURBINE USA	<table border="1"> <thead> <tr> <th>Code</th> <th>Description</th> <th>Qté</th> <th>UOM</th> </tr> </thead> <tbody> <tr> <td>VL1128A1</td> <td>CLAPET ANTIRETOUR BARBED D6</td> <td>1.000</td> <td>PCS</td> </tr> <tr> <td>VL1166A0</td> <td>RACCORD EN L BB6-AL6</td> <td>3.000</td> <td>PCS</td> </tr> <tr> <td>VL1174C0</td> <td>INJECTEUR ETALLONE D 1,2 MM</td> <td>1.000</td> <td>PCS</td> </tr> <tr> <td>VL1185A0</td> <td>DISTRIBUTEU R LAVAGE PLUS 2 VOIES PLUS</td> <td>1.000</td> <td>PCS</td> </tr> <tr> <td>VL1190A0</td> <td>DISTRIBUTEU R ENTREE LAVAGE PLUS</td> <td>1.000</td> <td>PCS</td> </tr> <tr> <td>VL1214A0</td> <td>CLAPET ANTI RETOUR BB6 BAIONETTE</td> <td>1.000</td> <td>PCS</td> </tr> <tr> <td>VL1398A0</td> <td>PRESSOSTAT N.O. 1/4 M CIL</td> <td>1.000</td> <td>PCS</td> </tr> <tr> <td>VM1605A0</td> <td>CLIP TWIST LOCK DIAM. 10,2-12,7 MM</td> <td>3.000</td> <td>PCS</td> </tr> <tr> <td>VM2172A0</td> <td>CLIP BLOCAGE POMPE AVEC CIRCUIT</td> <td>4.000</td> <td>PCS</td> </tr> </tbody> </table>	Code	Description	Qté	UOM	VL1128A1	CLAPET ANTIRETOUR BARBED D6	1.000	PCS	VL1166A0	RACCORD EN L BB6-AL6	3.000	PCS	VL1174C0	INJECTEUR ETALLONE D 1,2 MM	1.000	PCS	VL1185A0	DISTRIBUTEU R LAVAGE PLUS 2 VOIES PLUS	1.000	PCS	VL1190A0	DISTRIBUTEU R ENTREE LAVAGE PLUS	1.000	PCS	VL1214A0	CLAPET ANTI RETOUR BB6 BAIONETTE	1.000	PCS	VL1398A0	PRESSOSTAT N.O. 1/4 M CIL	1.000	PCS	VM1605A0	CLIP TWIST LOCK DIAM. 10,2-12,7 MM	3.000	PCS	VM2172A0	CLIP BLOCAGE POMPE AVEC CIRCUIT	4.000	PCS
			Code	Description	Qté	UOM																																							
VL1128A1	CLAPET ANTIRETOUR BARBED D6	1.000	PCS																																										
VL1166A0	RACCORD EN L BB6-AL6	3.000	PCS																																										
VL1174C0	INJECTEUR ETALLONE D 1,2 MM	1.000	PCS																																										
VL1185A0	DISTRIBUTEU R LAVAGE PLUS 2 VOIES PLUS	1.000	PCS																																										
VL1190A0	DISTRIBUTEU R ENTREE LAVAGE PLUS	1.000	PCS																																										
VL1214A0	CLAPET ANTI RETOUR BB6 BAIONETTE	1.000	PCS																																										
VL1398A0	PRESSOSTAT N.O. 1/4 M CIL	1.000	PCS																																										
VM1605A0	CLIP TWIST LOCK DIAM. 10,2-12,7 MM	3.000	PCS																																										
VM2172A0	CLIP BLOCAGE POMPE AVEC CIRCUIT	4.000	PCS																																										
KVL1198A	KIT SYSTEME LAVAGE HOTTE MM EU	<table border="1"> <thead> <tr> <th>Code</th> <th>Description</th> <th>Qté</th> <th>UOM</th> </tr> </thead> <tbody> <tr> <td>0H2213A1</td> <td>TOLE SYSTEME HYDRIQUE HOTTE</td> <td>1.000</td> <td>PCS</td> </tr> <tr> <td>EL1440A0</td> <td>ELECTROVAN NE H2O AUTONETTOY ANTE BAIONNET</td> <td>2.000</td> <td>PCS</td> </tr> <tr> <td>GN1526A0</td> <td>O-RING D.INT6,9 SP1,8</td> <td>5.000</td> <td>PCS</td> </tr> <tr> <td>RC1018A0</td> <td>COLLIER ELASTIQUE D12 ZINGUE</td> <td>1.000</td> <td>PCS</td> </tr> <tr> <td>RC1019A0</td> <td>COLLIER ELASTIQUE D10 ZINGUE</td> <td>14.000</td> <td>PCS</td> </tr> <tr> <td>RC1131A0</td> <td>COLLIER 200X2,6 NOIR</td> <td>1.000</td> <td>PCS</td> </tr> <tr> <td>RC1242A0</td> <td>EXTREMITÉ FERME</td> <td>2.000</td> <td>PCS</td> </tr> <tr> <td>RC1414A1</td> <td>COLLIER A COMPRESSIO N D11,5-12,5</td> <td>3.000</td> <td>PCS</td> </tr> <tr> <td>TB2821A0</td> <td>TB2820A-L=40 MM EPDM NOI</td> <td>4.000</td> <td>PCS</td> </tr> </tbody> </table>	Code	Description	Qté	UOM	0H2213A1	TOLE SYSTEME HYDRIQUE HOTTE	1.000	PCS	EL1440A0	ELECTROVAN NE H2O AUTONETTOY ANTE BAIONNET	2.000	PCS	GN1526A0	O-RING D.INT6,9 SP1,8	5.000	PCS	RC1018A0	COLLIER ELASTIQUE D12 ZINGUE	1.000	PCS	RC1019A0	COLLIER ELASTIQUE D10 ZINGUE	14.000	PCS	RC1131A0	COLLIER 200X2,6 NOIR	1.000	PCS	RC1242A0	EXTREMITÉ FERME	2.000	PCS	RC1414A1	COLLIER A COMPRESSIO N D11,5-12,5	3.000	PCS	TB2821A0	TB2820A-L=40 MM EPDM NOI	4.000	PCS			
Code	Description	Qté	UOM																																										
0H2213A1	TOLE SYSTEME HYDRIQUE HOTTE	1.000	PCS																																										
EL1440A0	ELECTROVAN NE H2O AUTONETTOY ANTE BAIONNET	2.000	PCS																																										
GN1526A0	O-RING D.INT6,9 SP1,8	5.000	PCS																																										
RC1018A0	COLLIER ELASTIQUE D12 ZINGUE	1.000	PCS																																										
RC1019A0	COLLIER ELASTIQUE D10 ZINGUE	14.000	PCS																																										
RC1131A0	COLLIER 200X2,6 NOIR	1.000	PCS																																										
RC1242A0	EXTREMITÉ FERME	2.000	PCS																																										
RC1414A1	COLLIER A COMPRESSIO N D11,5-12,5	3.000	PCS																																										
TB2821A0	TB2820A-L=40 MM EPDM NOI	4.000	PCS																																										

COMPOSANT			PIÈCE DE RECHANGE																																																																														
Code	Description	Image	Code	Description	Composants du kit																																																																												
VL1019A	POMPE DETERGENT VIBRATION		KVL1198A	KIT SYSTEME LAVAGE HOTTE MM EU	<table border="1"> <thead> <tr> <th>Code</th> <th>Description</th> <th>Qté</th> <th>UOM</th> </tr> </thead> <tbody> <tr> <td>TB2994A0</td> <td>TB2820A0-TUY AU DETERGENT CAMPANAS 1</td> <td>2.000</td> <td>PCS</td> </tr> <tr> <td>TB3252A0</td> <td>TB3252A0</td> <td>2.000</td> <td>PCS</td> </tr> <tr> <td>TB3614A0</td> <td></td> <td>1.000</td> <td>PCS</td> </tr> <tr> <td>VI1220A1</td> <td>VIS AUTOTARADE UX 4.2x12 TCB MARUTEX PRE</td> <td>3.000</td> <td>PCS</td> </tr> <tr> <td>VI2070A0</td> <td>VIS 40X8 TCB+ SHEETTRACS</td> <td>2.000</td> <td>PCS</td> </tr> <tr> <td>VL1019A0</td> <td>POMPE DETERGENT VIBRATION</td> <td>1.000</td> <td>PCS</td> </tr> <tr> <td>VL1047A1</td> <td>PORTEGOMM E D6-EXTREMIT E D8</td> <td>2.000</td> <td>PCS</td> </tr> <tr> <td>VL1054B0</td> <td>DISTRIBUTEU R ENTREES LAVAGES ONE</td> <td>1.000</td> <td>PCS</td> </tr> <tr> <td>VL1102A1</td> <td>FILTRE DANS LA LIGNE DET+VNR BARBED 6MM</td> <td>1.000</td> <td>PCS</td> </tr> <tr> <td>VL1127A1</td> <td>RACCORD T BARBED 6mm</td> <td>1.000</td> <td>PCS</td> </tr> <tr> <td>VL1128A1</td> <td>CLAPET ANTIRETOUR BARBED D6</td> <td>1.000</td> <td>PCS</td> </tr> <tr> <td>VL1165A0</td> <td>RACCORD DROIT BAM-BB6</td> <td>1.000</td> <td>PCS</td> </tr> <tr> <td>VL1166A0</td> <td>RACCORD EN L BB6-AL6</td> <td>2.000</td> <td>PCS</td> </tr> <tr> <td>VL1174C0</td> <td>INJECTEUR ETALLONE D 1.2 MM</td> <td>1.000</td> <td>PCS</td> </tr> <tr> <td>VL1191A0</td> <td>DISTRIBUTEU R SORTIE LAVAGE ONE</td> <td>1.000</td> <td>PCS</td> </tr> <tr> <td>VL1214A0</td> <td>CLAPET ANTI RETOUR BB6 BAIONETTE</td> <td>1.000</td> <td>PCS</td> </tr> <tr> <td>VM1605A0</td> <td>CLIP TWIST LOCK DIAM. 10.2-12.7 MM</td> <td>2.000</td> <td>PCS</td> </tr> <tr> <td>VM2172A0</td> <td>CLIP BLOCAGE POMPE AVEC CIRCUIT</td> <td>3.000</td> <td>PCS</td> </tr> </tbody> </table>	Code	Description	Qté	UOM	TB2994A0	TB2820A0-TUY AU DETERGENT CAMPANAS 1	2.000	PCS	TB3252A0	TB3252A0	2.000	PCS	TB3614A0		1.000	PCS	VI1220A1	VIS AUTOTARADE UX 4.2x12 TCB MARUTEX PRE	3.000	PCS	VI2070A0	VIS 40X8 TCB+ SHEETTRACS	2.000	PCS	VL1019A0	POMPE DETERGENT VIBRATION	1.000	PCS	VL1047A1	PORTEGOMM E D6-EXTREMIT E D8	2.000	PCS	VL1054B0	DISTRIBUTEU R ENTREES LAVAGES ONE	1.000	PCS	VL1102A1	FILTRE DANS LA LIGNE DET+VNR BARBED 6MM	1.000	PCS	VL1127A1	RACCORD T BARBED 6mm	1.000	PCS	VL1128A1	CLAPET ANTIRETOUR BARBED D6	1.000	PCS	VL1165A0	RACCORD DROIT BAM-BB6	1.000	PCS	VL1166A0	RACCORD EN L BB6-AL6	2.000	PCS	VL1174C0	INJECTEUR ETALLONE D 1.2 MM	1.000	PCS	VL1191A0	DISTRIBUTEU R SORTIE LAVAGE ONE	1.000	PCS	VL1214A0	CLAPET ANTI RETOUR BB6 BAIONETTE	1.000	PCS	VM1605A0	CLIP TWIST LOCK DIAM. 10.2-12.7 MM	2.000	PCS	VM2172A0	CLIP BLOCAGE POMPE AVEC CIRCUIT	3.000	PCS
Code	Description	Qté	UOM																																																																														
TB2994A0	TB2820A0-TUY AU DETERGENT CAMPANAS 1	2.000	PCS																																																																														
TB3252A0	TB3252A0	2.000	PCS																																																																														
TB3614A0		1.000	PCS																																																																														
VI1220A1	VIS AUTOTARADE UX 4.2x12 TCB MARUTEX PRE	3.000	PCS																																																																														
VI2070A0	VIS 40X8 TCB+ SHEETTRACS	2.000	PCS																																																																														
VL1019A0	POMPE DETERGENT VIBRATION	1.000	PCS																																																																														
VL1047A1	PORTEGOMM E D6-EXTREMIT E D8	2.000	PCS																																																																														
VL1054B0	DISTRIBUTEU R ENTREES LAVAGES ONE	1.000	PCS																																																																														
VL1102A1	FILTRE DANS LA LIGNE DET+VNR BARBED 6MM	1.000	PCS																																																																														
VL1127A1	RACCORD T BARBED 6mm	1.000	PCS																																																																														
VL1128A1	CLAPET ANTIRETOUR BARBED D6	1.000	PCS																																																																														
VL1165A0	RACCORD DROIT BAM-BB6	1.000	PCS																																																																														
VL1166A0	RACCORD EN L BB6-AL6	2.000	PCS																																																																														
VL1174C0	INJECTEUR ETALLONE D 1.2 MM	1.000	PCS																																																																														
VL1191A0	DISTRIBUTEU R SORTIE LAVAGE ONE	1.000	PCS																																																																														
VL1214A0	CLAPET ANTI RETOUR BB6 BAIONETTE	1.000	PCS																																																																														
VM1605A0	CLIP TWIST LOCK DIAM. 10.2-12.7 MM	2.000	PCS																																																																														
VM2172A0	CLIP BLOCAGE POMPE AVEC CIRCUIT	3.000	PCS																																																																														

COMPOSANT			PIÈCE DE RECHANGE																																																																																								
Code	Description	Image	Code	Description	Composants du kit																																																																																						
VL1019A	POMPE DETERGENT VIBRATION		KVL1187A	KIT SYSTEME LAVAGE 3 TOURNIQUETS EU	<table border="1"> <thead> <tr> <th>Code</th> <th>Description</th> <th>Qté</th> <th>UOM</th> </tr> </thead> <tbody> <tr> <td>0H2354A1</td> <td>TOLE SYSTEME LAVAGE PLUS XEVC-XEVL</td> <td>1.000</td> <td>PCS</td> </tr> <tr> <td>EL1440A0</td> <td>ELECTROVAN NE H2O AUTONETTOY ANTE BAIONNET</td> <td>4.000</td> <td>PCS</td> </tr> <tr> <td>GN1526A0</td> <td>O-RING D.INT6.9 SP1.8</td> <td>9.000</td> <td>PCS</td> </tr> <tr> <td>RC1018A0</td> <td>COLLIER ELASTIQUE D12 ZINGUE</td> <td>11.000</td> <td>PCS</td> </tr> <tr> <td>RC1019A0</td> <td>COLLIER ELASTIQUE D10 ZINGUE</td> <td>14.000</td> <td>PCS</td> </tr> <tr> <td>RC1130A0</td> <td>COLLIER 130X2.6</td> <td>1.000</td> <td>PCS</td> </tr> <tr> <td>RC1131A0</td> <td>COLLIER 200X2.6 NOIR</td> <td>3.000</td> <td>PCS</td> </tr> <tr> <td>RC1242A0</td> <td>EXTREMITE FERME</td> <td>2.000</td> <td>PCS</td> </tr> <tr> <td>RC1356A0</td> <td>RACCORD DROIT FIL FEMELLE 8X1/4 BSP</td> <td>1.000</td> <td>PCS</td> </tr> <tr> <td>RC1414A1</td> <td>COLLIER A COMPRESSIO N D11.5-12.5</td> <td>1.000</td> <td>PCS</td> </tr> <tr> <td>TB2652A0</td> <td></td> <td>1.000</td> <td>PCS</td> </tr> <tr> <td>TB2677A0</td> <td></td> <td>1.000</td> <td>PCS</td> </tr> <tr> <td>TB2821A0</td> <td>TB2820A-L=40 MM EPDM NOI</td> <td>4.000</td> <td>PCS</td> </tr> <tr> <td>TB3004A0</td> <td>TB2820A L=550mm EPDM BLACK PIPE</td> <td>2.000</td> <td>PCS</td> </tr> <tr> <td>TB3024C0</td> <td></td> <td>3.000</td> <td>PCS</td> </tr> <tr> <td>TB3226A0</td> <td></td> <td>1.000</td> <td>PCS</td> </tr> <tr> <td>TB3440A0</td> <td>TB3132A L=1050mm EPDM WHITE-BLUE PIPE</td> <td>1.000</td> <td>PCS</td> </tr> <tr> <td>TB3614A0</td> <td></td> <td>1.000</td> <td>PCS</td> </tr> <tr> <td>VI1220A1</td> <td>VIS AUTOTARADE UX 4.2x12 TCB MARUTEX PRE</td> <td>1.000</td> <td>PCS</td> </tr> <tr> <td>VL1019A0</td> <td>POMPE DETERGENT VIBRATION</td> <td></td> <td></td> <td></td> <td>1.000 PCS</td> </tr> </tbody> </table>	Code	Description	Qté	UOM	0H2354A1	TOLE SYSTEME LAVAGE PLUS XEVC-XEVL	1.000	PCS	EL1440A0	ELECTROVAN NE H2O AUTONETTOY ANTE BAIONNET	4.000	PCS	GN1526A0	O-RING D.INT6.9 SP1.8	9.000	PCS	RC1018A0	COLLIER ELASTIQUE D12 ZINGUE	11.000	PCS	RC1019A0	COLLIER ELASTIQUE D10 ZINGUE	14.000	PCS	RC1130A0	COLLIER 130X2.6	1.000	PCS	RC1131A0	COLLIER 200X2.6 NOIR	3.000	PCS	RC1242A0	EXTREMITE FERME	2.000	PCS	RC1356A0	RACCORD DROIT FIL FEMELLE 8X1/4 BSP	1.000	PCS	RC1414A1	COLLIER A COMPRESSIO N D11.5-12.5	1.000	PCS	TB2652A0		1.000	PCS	TB2677A0		1.000	PCS	TB2821A0	TB2820A-L=40 MM EPDM NOI	4.000	PCS	TB3004A0	TB2820A L=550mm EPDM BLACK PIPE	2.000	PCS	TB3024C0		3.000	PCS	TB3226A0		1.000	PCS	TB3440A0	TB3132A L=1050mm EPDM WHITE-BLUE PIPE	1.000	PCS	TB3614A0		1.000	PCS	VI1220A1	VIS AUTOTARADE UX 4.2x12 TCB MARUTEX PRE	1.000	PCS	VL1019A0	POMPE DETERGENT VIBRATION				1.000 PCS
Code	Description	Qté	UOM																																																																																								
0H2354A1	TOLE SYSTEME LAVAGE PLUS XEVC-XEVL	1.000	PCS																																																																																								
EL1440A0	ELECTROVAN NE H2O AUTONETTOY ANTE BAIONNET	4.000	PCS																																																																																								
GN1526A0	O-RING D.INT6.9 SP1.8	9.000	PCS																																																																																								
RC1018A0	COLLIER ELASTIQUE D12 ZINGUE	11.000	PCS																																																																																								
RC1019A0	COLLIER ELASTIQUE D10 ZINGUE	14.000	PCS																																																																																								
RC1130A0	COLLIER 130X2.6	1.000	PCS																																																																																								
RC1131A0	COLLIER 200X2.6 NOIR	3.000	PCS																																																																																								
RC1242A0	EXTREMITE FERME	2.000	PCS																																																																																								
RC1356A0	RACCORD DROIT FIL FEMELLE 8X1/4 BSP	1.000	PCS																																																																																								
RC1414A1	COLLIER A COMPRESSIO N D11.5-12.5	1.000	PCS																																																																																								
TB2652A0		1.000	PCS																																																																																								
TB2677A0		1.000	PCS																																																																																								
TB2821A0	TB2820A-L=40 MM EPDM NOI	4.000	PCS																																																																																								
TB3004A0	TB2820A L=550mm EPDM BLACK PIPE	2.000	PCS																																																																																								
TB3024C0		3.000	PCS																																																																																								
TB3226A0		1.000	PCS																																																																																								
TB3440A0	TB3132A L=1050mm EPDM WHITE-BLUE PIPE	1.000	PCS																																																																																								
TB3614A0		1.000	PCS																																																																																								
VI1220A1	VIS AUTOTARADE UX 4.2x12 TCB MARUTEX PRE	1.000	PCS																																																																																								
VL1019A0	POMPE DETERGENT VIBRATION				1.000 PCS																																																																																						

COMPOSANT			PIÈCE DE RECHANGE																																																																													
Code	Description	Image	Code	Description	Composants du kit																																																																											
VL1019A	POMPE DETERGENT VIBRATION		KVL1187A	KIT SYSTEME LAVAGE 3 TOURNIQUETS EU	<table border="1"> <thead> <tr> <th>Code</th> <th>Description</th> <th>Qté</th> <th>UOM</th> </tr> </thead> <tbody> <tr> <td>VL1047A1</td> <td>PORTEGOMM E D6-EXTREMIT E D8</td> <td>1.000</td> <td>PCS</td> </tr> <tr> <td>VL1065A1</td> <td>PRESSOSTAT N.O. 1/4 M CIL</td> <td>1.000</td> <td>PCS</td> </tr> <tr> <td>VL1102A1</td> <td>FILTRE DANS LA LIGNE DET+VNR BARBED 6MM</td> <td>1.000</td> <td>PCS</td> </tr> <tr> <td>VL1127A1</td> <td>RACCORD T BARBED 6mm</td> <td>2.000</td> <td>PCS</td> </tr> <tr> <td>VL1128A1</td> <td>CLAPET ANTIRETOUR BARBED D6</td> <td>2.000</td> <td>PCS</td> </tr> <tr> <td>VL1166A0</td> <td>RACCORD EN L BB6-AL6</td> <td>4.000</td> <td>PCS</td> </tr> <tr> <td>VL1167A2</td> <td>REDUCTEUR DE DEBIT 3 BRAS DE LAVAGE GN21</td> <td>1.000</td> <td>PCS</td> </tr> <tr> <td>VL1174C0</td> <td>INJECTEUR ETALLONE D 1.2 MM</td> <td>1.000</td> <td>PCS</td> </tr> <tr> <td>VL1186A0</td> <td>DISTRIBUTEU R LAVAGE PLUS 3 VOIES GICLÉUR</td> <td>1.000</td> <td>PCS</td> </tr> <tr> <td>VL1190A0</td> <td>DISTRIBUTEU R ENTREE LAVAGE PLUS</td> <td>1.000</td> <td>PCS</td> </tr> <tr> <td>VL1214A0</td> <td>CLAPET ANTI RETOUR BB6 BAIONNETTE</td> <td>1.000</td> <td>PCS</td> </tr> <tr> <td>VM1605A0</td> <td>CLIP TWIST LOCK DIAM. 10.2-12.7 MM</td> <td>3.000</td> <td>PCS</td> </tr> <tr> <td>VM2172A0</td> <td>CLIP BLOCAGE POMPE AVEC CIRCUIT</td> <td>5.000</td> <td>PCS</td> </tr> </tbody> </table>	Code	Description	Qté	UOM	VL1047A1	PORTEGOMM E D6-EXTREMIT E D8	1.000	PCS	VL1065A1	PRESSOSTAT N.O. 1/4 M CIL	1.000	PCS	VL1102A1	FILTRE DANS LA LIGNE DET+VNR BARBED 6MM	1.000	PCS	VL1127A1	RACCORD T BARBED 6mm	2.000	PCS	VL1128A1	CLAPET ANTIRETOUR BARBED D6	2.000	PCS	VL1166A0	RACCORD EN L BB6-AL6	4.000	PCS	VL1167A2	REDUCTEUR DE DEBIT 3 BRAS DE LAVAGE GN21	1.000	PCS	VL1174C0	INJECTEUR ETALLONE D 1.2 MM	1.000	PCS	VL1186A0	DISTRIBUTEU R LAVAGE PLUS 3 VOIES GICLÉUR	1.000	PCS	VL1190A0	DISTRIBUTEU R ENTREE LAVAGE PLUS	1.000	PCS	VL1214A0	CLAPET ANTI RETOUR BB6 BAIONNETTE	1.000	PCS	VM1605A0	CLIP TWIST LOCK DIAM. 10.2-12.7 MM	3.000	PCS	VM2172A0	CLIP BLOCAGE POMPE AVEC CIRCUIT	5.000	PCS	KVL1184A	KIT SYSTEME LAVAGE 2 TOURNIQUETS EU	<table border="1"> <thead> <tr> <th>Code</th> <th>Description</th> <th>Qté</th> <th>UOM</th> </tr> </thead> <tbody> <tr> <td>0H2354A1</td> <td>TOLE SYSTEME LAVAGE PLUS XEVC-XEVL</td> <td>1.000</td> <td>PCS</td> </tr> <tr> <td>EL1440A0</td> <td>ELECTROVAN NE H20 AUTONETTOY ANTE BAIONNET</td> <td>4.000</td> <td>PCS</td> </tr> <tr> <td>GN1526A0</td> <td>O-RING D.INT6.9 SP1.8</td> <td>9.000</td> <td>PCS</td> </tr> </tbody> </table>	Code	Description	Qté	UOM	0H2354A1	TOLE SYSTEME LAVAGE PLUS XEVC-XEVL	1.000	PCS	EL1440A0	ELECTROVAN NE H20 AUTONETTOY ANTE BAIONNET	4.000	PCS	GN1526A0	O-RING D.INT6.9 SP1.8	9.000	PCS
			Code	Description	Qté	UOM																																																																										
VL1047A1	PORTEGOMM E D6-EXTREMIT E D8	1.000	PCS																																																																													
VL1065A1	PRESSOSTAT N.O. 1/4 M CIL	1.000	PCS																																																																													
VL1102A1	FILTRE DANS LA LIGNE DET+VNR BARBED 6MM	1.000	PCS																																																																													
VL1127A1	RACCORD T BARBED 6mm	2.000	PCS																																																																													
VL1128A1	CLAPET ANTIRETOUR BARBED D6	2.000	PCS																																																																													
VL1166A0	RACCORD EN L BB6-AL6	4.000	PCS																																																																													
VL1167A2	REDUCTEUR DE DEBIT 3 BRAS DE LAVAGE GN21	1.000	PCS																																																																													
VL1174C0	INJECTEUR ETALLONE D 1.2 MM	1.000	PCS																																																																													
VL1186A0	DISTRIBUTEU R LAVAGE PLUS 3 VOIES GICLÉUR	1.000	PCS																																																																													
VL1190A0	DISTRIBUTEU R ENTREE LAVAGE PLUS	1.000	PCS																																																																													
VL1214A0	CLAPET ANTI RETOUR BB6 BAIONNETTE	1.000	PCS																																																																													
VM1605A0	CLIP TWIST LOCK DIAM. 10.2-12.7 MM	3.000	PCS																																																																													
VM2172A0	CLIP BLOCAGE POMPE AVEC CIRCUIT	5.000	PCS																																																																													
Code	Description	Qté	UOM																																																																													
0H2354A1	TOLE SYSTEME LAVAGE PLUS XEVC-XEVL	1.000	PCS																																																																													
EL1440A0	ELECTROVAN NE H20 AUTONETTOY ANTE BAIONNET	4.000	PCS																																																																													
GN1526A0	O-RING D.INT6.9 SP1.8	9.000	PCS																																																																													

COMPOSANT			PIÈCE DE RECHANGE																																																																																
Code	Description	Image	Code	Description	Composants du kit																																																																														
VL1019A	POMPE DETERGENT VIBRATION		KVL1184A	KIT SYSTEME LAVAGE 2 TOURNIQUETS EU	<table border="1"> <thead> <tr> <th>Code</th> <th>Description</th> <th>Qté</th> <th>UOM</th> </tr> </thead> <tbody> <tr> <td>RC1018A0</td> <td>COLLIER ELASTIQUE D12 ZINGUE</td> <td>2.000</td> <td>PCS</td> </tr> <tr> <td>RC1019A0</td> <td>COLLIER ELASTIQUE D10 ZINGUE</td> <td>13.000</td> <td>PCS</td> </tr> <tr> <td>RC1130A0</td> <td>COLLIER 130X2.6</td> <td>1.000</td> <td>PCS</td> </tr> <tr> <td>RC1131A0</td> <td>COLLIER 200X2.6 NOIR</td> <td>3.000</td> <td>PCS</td> </tr> <tr> <td>RC1242A0</td> <td>EXTREMITE FERME</td> <td>2.000</td> <td>PCS</td> </tr> <tr> <td>RC1356A0</td> <td>RACCORD DROIT FIL FEMELLE 8X1/4 BSP</td> <td>1.000</td> <td>PCS</td> </tr> <tr> <td>RC1414A1</td> <td>COLLIER A COMPRESSIO N D11.5-12.5</td> <td>1.000</td> <td>PCS</td> </tr> <tr> <td>TB2821A0</td> <td>TB2820A-L=40 MM EPDM NOI</td> <td>4.000</td> <td>PCS</td> </tr> <tr> <td>TB2994A0</td> <td>TB2820A0-TUY AU DETERGENT CAMPANAS 1</td> <td>1.000</td> <td>PCS</td> </tr> <tr> <td>TB3004A0</td> <td>TB2820A L=550mm EPDM BLACK PIPE</td> <td>2.000</td> <td>PCS</td> </tr> <tr> <td>TB3005B0</td> <td>TB3132A L=550mm EPDM WHITE-BLUE PIPE</td> <td>1.000</td> <td>PCS</td> </tr> <tr> <td>TB3440A0</td> <td>TB3132A L=1050mm EPDM WHITE-BLUE PIPE</td> <td>1.000</td> <td>PCS</td> </tr> <tr> <td>TB3614A0</td> <td></td> <td>1.000</td> <td>PCS</td> </tr> <tr> <td>VH1220A1</td> <td>VIS AUTOTARADE UX 4.2x12 TCB MARUTEX PRE</td> <td>1.000</td> <td>PCS</td> </tr> <tr> <td>VL1019A0</td> <td>POMPE DETERGENT VIBRATION</td> <td></td> <td></td> <td>1.000</td> <td>PCS</td> </tr> <tr> <td>VL1047A1</td> <td>PORTEGOMM E D6-EXTREMIT E D8</td> <td></td> <td></td> <td>1.000</td> <td>PCS</td> </tr> <tr> <td>VL1065A1</td> <td>PRESSOSTAT N.O. 1/4 M CIL</td> <td></td> <td></td> <td>1.000</td> <td>PCS</td> </tr> </tbody> </table>	Code	Description	Qté	UOM	RC1018A0	COLLIER ELASTIQUE D12 ZINGUE	2.000	PCS	RC1019A0	COLLIER ELASTIQUE D10 ZINGUE	13.000	PCS	RC1130A0	COLLIER 130X2.6	1.000	PCS	RC1131A0	COLLIER 200X2.6 NOIR	3.000	PCS	RC1242A0	EXTREMITE FERME	2.000	PCS	RC1356A0	RACCORD DROIT FIL FEMELLE 8X1/4 BSP	1.000	PCS	RC1414A1	COLLIER A COMPRESSIO N D11.5-12.5	1.000	PCS	TB2821A0	TB2820A-L=40 MM EPDM NOI	4.000	PCS	TB2994A0	TB2820A0-TUY AU DETERGENT CAMPANAS 1	1.000	PCS	TB3004A0	TB2820A L=550mm EPDM BLACK PIPE	2.000	PCS	TB3005B0	TB3132A L=550mm EPDM WHITE-BLUE PIPE	1.000	PCS	TB3440A0	TB3132A L=1050mm EPDM WHITE-BLUE PIPE	1.000	PCS	TB3614A0		1.000	PCS	VH1220A1	VIS AUTOTARADE UX 4.2x12 TCB MARUTEX PRE	1.000	PCS	VL1019A0	POMPE DETERGENT VIBRATION			1.000	PCS	VL1047A1	PORTEGOMM E D6-EXTREMIT E D8			1.000	PCS	VL1065A1	PRESSOSTAT N.O. 1/4 M CIL			1.000	PCS
Code	Description	Qté	UOM																																																																																
RC1018A0	COLLIER ELASTIQUE D12 ZINGUE	2.000	PCS																																																																																
RC1019A0	COLLIER ELASTIQUE D10 ZINGUE	13.000	PCS																																																																																
RC1130A0	COLLIER 130X2.6	1.000	PCS																																																																																
RC1131A0	COLLIER 200X2.6 NOIR	3.000	PCS																																																																																
RC1242A0	EXTREMITE FERME	2.000	PCS																																																																																
RC1356A0	RACCORD DROIT FIL FEMELLE 8X1/4 BSP	1.000	PCS																																																																																
RC1414A1	COLLIER A COMPRESSIO N D11.5-12.5	1.000	PCS																																																																																
TB2821A0	TB2820A-L=40 MM EPDM NOI	4.000	PCS																																																																																
TB2994A0	TB2820A0-TUY AU DETERGENT CAMPANAS 1	1.000	PCS																																																																																
TB3004A0	TB2820A L=550mm EPDM BLACK PIPE	2.000	PCS																																																																																
TB3005B0	TB3132A L=550mm EPDM WHITE-BLUE PIPE	1.000	PCS																																																																																
TB3440A0	TB3132A L=1050mm EPDM WHITE-BLUE PIPE	1.000	PCS																																																																																
TB3614A0		1.000	PCS																																																																																
VH1220A1	VIS AUTOTARADE UX 4.2x12 TCB MARUTEX PRE	1.000	PCS																																																																																
VL1019A0	POMPE DETERGENT VIBRATION			1.000	PCS																																																																														
VL1047A1	PORTEGOMM E D6-EXTREMIT E D8			1.000	PCS																																																																														
VL1065A1	PRESSOSTAT N.O. 1/4 M CIL			1.000	PCS																																																																														

COMPOSANT			PIÈCE DE RECHANGE																																										
Code	Description	Image	Code	Description	Composants du kit																																								
VL1019A	POMPE DETERGENT VIBRATION		KVL1184A	KIT SYSTEME LAVAGE 2 TOURNIQUETS EU	<table border="1"> <thead> <tr> <th>Code</th> <th>Description</th> <th>Qté</th> <th>UOM</th> </tr> </thead> <tbody> <tr> <td>VL1102A1</td> <td>FILTRE DANS LA LIGNE DET+VNR BARBED 6MM</td> <td>1.000</td> <td>PCS</td> </tr> <tr> <td>VL1128A1</td> <td>CLAPET ANTIRETOUR BARBED D6</td> <td>1.000</td> <td>PCS</td> </tr> <tr> <td>VL1166A0</td> <td>RACCORD EN L BB6-AL6</td> <td>4.000</td> <td>PCS</td> </tr> <tr> <td>VL1174C0</td> <td>INJECTEUR ETALLONE D 1.2 MM</td> <td>1.000</td> <td>PCS</td> </tr> <tr> <td>VL1186A0</td> <td>DISTRIBUTEU R LAVAGE PLUS 3 VOIES GICLÉUR</td> <td>1.000</td> <td>PCS</td> </tr> <tr> <td>VL1190A0</td> <td>DISTRIBUTEU R ENTREE LAVAGE PLUS</td> <td>1.000</td> <td>PCS</td> </tr> <tr> <td>VL1214A0</td> <td>CLAPET ANTI RETOUR BB6 BAIONNETTE</td> <td>1.000</td> <td>PCS</td> </tr> <tr> <td>VM1605A0</td> <td>CLIP TWIST LOCK DIAM. 10,2-12,7 MM</td> <td>3.000</td> <td>PCS</td> </tr> <tr> <td>VM2172A0</td> <td>CLIP BLOCAGE POMPE AVEC CIRCUIT</td> <td>5.000</td> <td>PCS</td> </tr> </tbody> </table>	Code	Description	Qté	UOM	VL1102A1	FILTRE DANS LA LIGNE DET+VNR BARBED 6MM	1.000	PCS	VL1128A1	CLAPET ANTIRETOUR BARBED D6	1.000	PCS	VL1166A0	RACCORD EN L BB6-AL6	4.000	PCS	VL1174C0	INJECTEUR ETALLONE D 1.2 MM	1.000	PCS	VL1186A0	DISTRIBUTEU R LAVAGE PLUS 3 VOIES GICLÉUR	1.000	PCS	VL1190A0	DISTRIBUTEU R ENTREE LAVAGE PLUS	1.000	PCS	VL1214A0	CLAPET ANTI RETOUR BB6 BAIONNETTE	1.000	PCS	VM1605A0	CLIP TWIST LOCK DIAM. 10,2-12,7 MM	3.000	PCS	VM2172A0	CLIP BLOCAGE POMPE AVEC CIRCUIT	5.000	PCS
			Code	Description	Qté	UOM																																							
VL1102A1	FILTRE DANS LA LIGNE DET+VNR BARBED 6MM	1.000	PCS																																										
VL1128A1	CLAPET ANTIRETOUR BARBED D6	1.000	PCS																																										
VL1166A0	RACCORD EN L BB6-AL6	4.000	PCS																																										
VL1174C0	INJECTEUR ETALLONE D 1.2 MM	1.000	PCS																																										
VL1186A0	DISTRIBUTEU R LAVAGE PLUS 3 VOIES GICLÉUR	1.000	PCS																																										
VL1190A0	DISTRIBUTEU R ENTREE LAVAGE PLUS	1.000	PCS																																										
VL1214A0	CLAPET ANTI RETOUR BB6 BAIONNETTE	1.000	PCS																																										
VM1605A0	CLIP TWIST LOCK DIAM. 10,2-12,7 MM	3.000	PCS																																										
VM2172A0	CLIP BLOCAGE POMPE AVEC CIRCUIT	5.000	PCS																																										
KVL1183A	KIT SYSTEME LAVAGE PLUS 1 BRAS	<table border="1"> <thead> <tr> <th>Code</th> <th>Description</th> <th>Qté</th> <th>UOM</th> </tr> </thead> <tbody> <tr> <td>0H2354A1</td> <td>TOLE SYSTEME LAVAGE PLUS XEVC-XEVL</td> <td>1.000</td> <td>PCS</td> </tr> <tr> <td>EL1440A0</td> <td>ELECTROVAN NE H20 AUTONETTOY ANTE BAIONNET</td> <td>3.000</td> <td>PCS</td> </tr> <tr> <td>GN1526A0</td> <td>O-RING D.INT6,9 SP1.8</td> <td>7.000</td> <td>PCS</td> </tr> <tr> <td>RC1018A0</td> <td>COLLIER ELASTIQUE D12 ZINGUE</td> <td>1.000</td> <td>PCS</td> </tr> <tr> <td>RC1019A0</td> <td>COLLIER ELASTIQUE D10 ZINGUE</td> <td>12.000</td> <td>PCS</td> </tr> <tr> <td>RC1130A0</td> <td>COLLIER 130X2,6</td> <td>1.000</td> <td>PCS</td> </tr> <tr> <td>RC1131A0</td> <td>COLLIER 200X2,6 NOIR</td> <td>2.000</td> <td>PCS</td> </tr> <tr> <td>RC1242A0</td> <td>EXTREMITE FERME</td> <td>2.000</td> <td>PCS</td> </tr> </tbody> </table>	Code	Description	Qté	UOM	0H2354A1	TOLE SYSTEME LAVAGE PLUS XEVC-XEVL	1.000	PCS	EL1440A0	ELECTROVAN NE H20 AUTONETTOY ANTE BAIONNET	3.000	PCS	GN1526A0	O-RING D.INT6,9 SP1.8	7.000	PCS	RC1018A0	COLLIER ELASTIQUE D12 ZINGUE	1.000	PCS	RC1019A0	COLLIER ELASTIQUE D10 ZINGUE	12.000	PCS	RC1130A0	COLLIER 130X2,6	1.000	PCS	RC1131A0	COLLIER 200X2,6 NOIR	2.000	PCS	RC1242A0	EXTREMITE FERME	2.000	PCS							
Code	Description	Qté	UOM																																										
0H2354A1	TOLE SYSTEME LAVAGE PLUS XEVC-XEVL	1.000	PCS																																										
EL1440A0	ELECTROVAN NE H20 AUTONETTOY ANTE BAIONNET	3.000	PCS																																										
GN1526A0	O-RING D.INT6,9 SP1.8	7.000	PCS																																										
RC1018A0	COLLIER ELASTIQUE D12 ZINGUE	1.000	PCS																																										
RC1019A0	COLLIER ELASTIQUE D10 ZINGUE	12.000	PCS																																										
RC1130A0	COLLIER 130X2,6	1.000	PCS																																										
RC1131A0	COLLIER 200X2,6 NOIR	2.000	PCS																																										
RC1242A0	EXTREMITE FERME	2.000	PCS																																										

COMPOSANT			PIÈCE DE RECHANGE																																																																																																
Code	Description	Image	Code	Description	Composants du kit																																																																																														
VL1019A	POMPE DETERGENT VIBRATION		KVL1183A	KIT SYSTEME LAVAGE PLUS 1 BRAS	<table border="1"> <thead> <tr> <th>Code</th> <th>Description</th> <th>Qté</th> <th>UOM</th> </tr> </thead> <tbody> <tr> <td>RC1356A0</td> <td>RACCORD DROIT FIL FEMELLE 8X1/4 BSP</td> <td>1.000</td> <td>PCS</td> </tr> <tr> <td>RC1414A1</td> <td>COLLIER A COMPRESSIO N D11.5-12.5</td> <td>1.000</td> <td>PCS</td> </tr> <tr> <td>TB2821A0</td> <td>TB2820A-L=40 MM EPDM NOI</td> <td>4.000</td> <td>PCS</td> </tr> <tr> <td>TB3004A0</td> <td>TB2820A L=550mm EPDM BLACK PIPE</td> <td>1.000</td> <td>PCS</td> </tr> <tr> <td>TB3005B0</td> <td>TB3132A L=550mm EPDM WHITE-BLUE PIPE</td> <td>1.000</td> <td>PCS</td> </tr> <tr> <td>TB3225B0</td> <td>TB2820A-L=67 0MM EPDM NOIR</td> <td>1.000</td> <td>PCS</td> </tr> <tr> <td>TB3252A0</td> <td>TB3252A0</td> <td>1.000</td> <td>PCS</td> </tr> <tr> <td>TB3614A0</td> <td></td> <td>1.000</td> <td>PCS</td> </tr> <tr> <td>VI1220A1</td> <td>VIS AUTOTARADE UX 4.2x12 TCB MARUTEX PRE</td> <td>1.000</td> <td>PCS</td> </tr> <tr> <td>VL1019A0</td> <td>POMPE DETERGENT VIBRATION</td> <td></td> <td></td> <td>1.000</td> <td>PCS</td> </tr> <tr> <td>VL1047A1</td> <td>PORTEGOMM E D6-EXTREMIT E D8</td> <td></td> <td></td> <td>1.000</td> <td>PCS</td> </tr> <tr> <td>VL1065A1</td> <td>PRESSOSTAT N.O. 1/4 M CIL</td> <td></td> <td></td> <td>1.000</td> <td>PCS</td> </tr> <tr> <td>VL1102A1</td> <td>FILTRE DANS LA LIGNE DET+VNR BARBED 6MM</td> <td></td> <td></td> <td>1.000</td> <td>PCS</td> </tr> <tr> <td>VL1128A1</td> <td>CLAPET ANTIRETOUR BARBED D6</td> <td></td> <td></td> <td>1.000</td> <td>PCS</td> </tr> <tr> <td>VL1166A0</td> <td>RACCORD EN L BB6-AL6</td> <td></td> <td></td> <td>3.000</td> <td>PCS</td> </tr> <tr> <td>VL1174C0</td> <td>INJECTEUR ETALLONE D 1.2 MM</td> <td></td> <td></td> <td>1.000</td> <td>PCS</td> </tr> <tr> <td>VL1185A0</td> <td>DISTRIBUTEU R LAVAGE PLUS 2 VOIES PLUS</td> <td></td> <td></td> <td>1.000</td> <td>PCS</td> </tr> <tr> <td>VL1190A0</td> <td>DISTRIBUTEU R ENTREE LAVAGE PLUS</td> <td></td> <td></td> <td>1.000</td> <td>PCS</td> </tr> </tbody> </table>	Code	Description	Qté	UOM	RC1356A0	RACCORD DROIT FIL FEMELLE 8X1/4 BSP	1.000	PCS	RC1414A1	COLLIER A COMPRESSIO N D11.5-12.5	1.000	PCS	TB2821A0	TB2820A-L=40 MM EPDM NOI	4.000	PCS	TB3004A0	TB2820A L=550mm EPDM BLACK PIPE	1.000	PCS	TB3005B0	TB3132A L=550mm EPDM WHITE-BLUE PIPE	1.000	PCS	TB3225B0	TB2820A-L=67 0MM EPDM NOIR	1.000	PCS	TB3252A0	TB3252A0	1.000	PCS	TB3614A0		1.000	PCS	VI1220A1	VIS AUTOTARADE UX 4.2x12 TCB MARUTEX PRE	1.000	PCS	VL1019A0	POMPE DETERGENT VIBRATION			1.000	PCS	VL1047A1	PORTEGOMM E D6-EXTREMIT E D8			1.000	PCS	VL1065A1	PRESSOSTAT N.O. 1/4 M CIL			1.000	PCS	VL1102A1	FILTRE DANS LA LIGNE DET+VNR BARBED 6MM			1.000	PCS	VL1128A1	CLAPET ANTIRETOUR BARBED D6			1.000	PCS	VL1166A0	RACCORD EN L BB6-AL6			3.000	PCS	VL1174C0	INJECTEUR ETALLONE D 1.2 MM			1.000	PCS	VL1185A0	DISTRIBUTEU R LAVAGE PLUS 2 VOIES PLUS			1.000	PCS	VL1190A0	DISTRIBUTEU R ENTREE LAVAGE PLUS			1.000	PCS
Code	Description	Qté	UOM																																																																																																
RC1356A0	RACCORD DROIT FIL FEMELLE 8X1/4 BSP	1.000	PCS																																																																																																
RC1414A1	COLLIER A COMPRESSIO N D11.5-12.5	1.000	PCS																																																																																																
TB2821A0	TB2820A-L=40 MM EPDM NOI	4.000	PCS																																																																																																
TB3004A0	TB2820A L=550mm EPDM BLACK PIPE	1.000	PCS																																																																																																
TB3005B0	TB3132A L=550mm EPDM WHITE-BLUE PIPE	1.000	PCS																																																																																																
TB3225B0	TB2820A-L=67 0MM EPDM NOIR	1.000	PCS																																																																																																
TB3252A0	TB3252A0	1.000	PCS																																																																																																
TB3614A0		1.000	PCS																																																																																																
VI1220A1	VIS AUTOTARADE UX 4.2x12 TCB MARUTEX PRE	1.000	PCS																																																																																																
VL1019A0	POMPE DETERGENT VIBRATION			1.000	PCS																																																																																														
VL1047A1	PORTEGOMM E D6-EXTREMIT E D8			1.000	PCS																																																																																														
VL1065A1	PRESSOSTAT N.O. 1/4 M CIL			1.000	PCS																																																																																														
VL1102A1	FILTRE DANS LA LIGNE DET+VNR BARBED 6MM			1.000	PCS																																																																																														
VL1128A1	CLAPET ANTIRETOUR BARBED D6			1.000	PCS																																																																																														
VL1166A0	RACCORD EN L BB6-AL6			3.000	PCS																																																																																														
VL1174C0	INJECTEUR ETALLONE D 1.2 MM			1.000	PCS																																																																																														
VL1185A0	DISTRIBUTEU R LAVAGE PLUS 2 VOIES PLUS			1.000	PCS																																																																																														
VL1190A0	DISTRIBUTEU R ENTREE LAVAGE PLUS			1.000	PCS																																																																																														

COMPOSANT			PIÈCE DE RECHANGE																																																											
Code	Description	Image	Code	Description	Composants du kit																																																									
VL1019A	POMPE DETERGENT VIBRATION		KVL1183A	KIT SYSTEME LAVAGE PLUS 1 BRAS	<table border="1"> <thead> <tr> <th>Code</th> <th>Description</th> <th>Qté</th> <th>UOM</th> </tr> </thead> <tbody> <tr> <td>VL1214A0</td> <td>CLAPET ANTI RETOUR BB6 BAIONETTE</td> <td>1.000</td> <td>PCS</td> </tr> <tr> <td>VM1605A0</td> <td>CLIP TWIST LOCK DIAM. 10,2-12,7 MM</td> <td>3.000</td> <td>PCS</td> </tr> <tr> <td>VM2172A0</td> <td>CLIP BLOCAGE POMPE AVEC CIRCUIT</td> <td>4.000</td> <td>PCS</td> </tr> </tbody> </table>	Code	Description	Qté	UOM	VL1214A0	CLAPET ANTI RETOUR BB6 BAIONETTE	1.000	PCS	VM1605A0	CLIP TWIST LOCK DIAM. 10,2-12,7 MM	3.000	PCS	VM2172A0	CLIP BLOCAGE POMPE AVEC CIRCUIT	4.000	PCS																																									
			Code	Description	Qté	UOM																																																								
VL1214A0	CLAPET ANTI RETOUR BB6 BAIONETTE	1.000	PCS																																																											
VM1605A0	CLIP TWIST LOCK DIAM. 10,2-12,7 MM	3.000	PCS																																																											
VM2172A0	CLIP BLOCAGE POMPE AVEC CIRCUIT	4.000	PCS																																																											
KVL1182A	KIT SYSTEME LAVAGE ONE (SAUF 0311)	<table border="1"> <thead> <tr> <th>Code</th> <th>Description</th> <th>Qté</th> <th>UOM</th> </tr> </thead> <tbody> <tr> <td>0H2202A1</td> <td>SYSTEME DE LAVAGE ONE AVEC EL VAPEUR</td> <td>1.000</td> <td>PCS</td> </tr> <tr> <td>EL1440A0</td> <td>ELECTROVAN NE H2O AUTONETTOY ANTE BAIONNET</td> <td>1.000</td> <td>PCS</td> </tr> <tr> <td>GN1526A0</td> <td>O-RING D.INT6,9 SP1.8</td> <td>3.000</td> <td>PCS</td> </tr> <tr> <td>RC1019A0</td> <td>COLLIER ELASTIQUE D10 ZINGUE</td> <td>12.000</td> <td>PCS</td> </tr> <tr> <td>RC1242A0</td> <td>EXTREMITÉ FERME</td> <td>2.000</td> <td>PCS</td> </tr> <tr> <td>RC1414A1</td> <td>COLLIER A COMPRESSIO N D11,5-12,5</td> <td>1.000</td> <td>PCS</td> </tr> <tr> <td>TB2821A0</td> <td>TB2820A-L=40 MM EPDM NOI</td> <td>4.000</td> <td>PCS</td> </tr> <tr> <td>TB3004A0</td> <td>TB2820A L=550mm EPDM BLACK PIPE</td> <td>1.000</td> <td>PCS</td> </tr> <tr> <td>TB3009B0</td> <td>TB3132A-ONE OVEN WASHING INLET</td> <td>1.000</td> <td>PCS</td> </tr> <tr> <td>TB3225B0</td> <td>TB2820A-L=67 0MM EPDM NOIR</td> <td>1.000</td> <td>PCS</td> </tr> <tr> <td>TB3614A0</td> <td></td> <td>1.000</td> <td>PCS</td> </tr> <tr> <td>VI1220A1</td> <td>VIS AUTOTARADE UX 4.2x12 TCB MARUTEX PRE</td> <td>2.000</td> <td>PCS</td> </tr> <tr> <td>VL1019A0</td> <td>POMPE DETERGENT VIBRATION</td> <td>1.000</td> <td>PCS</td> </tr> <tr> <td>VL1047A1</td> <td>PORTEGOMM E D6-EXTREMIT E D8</td> <td>1.000</td> <td>PCS</td> </tr> </tbody> </table>	Code	Description	Qté	UOM	0H2202A1	SYSTEME DE LAVAGE ONE AVEC EL VAPEUR	1.000	PCS	EL1440A0	ELECTROVAN NE H2O AUTONETTOY ANTE BAIONNET	1.000	PCS	GN1526A0	O-RING D.INT6,9 SP1.8	3.000	PCS	RC1019A0	COLLIER ELASTIQUE D10 ZINGUE	12.000	PCS	RC1242A0	EXTREMITÉ FERME	2.000	PCS	RC1414A1	COLLIER A COMPRESSIO N D11,5-12,5	1.000	PCS	TB2821A0	TB2820A-L=40 MM EPDM NOI	4.000	PCS	TB3004A0	TB2820A L=550mm EPDM BLACK PIPE	1.000	PCS	TB3009B0	TB3132A-ONE OVEN WASHING INLET	1.000	PCS	TB3225B0	TB2820A-L=67 0MM EPDM NOIR	1.000	PCS	TB3614A0		1.000	PCS	VI1220A1	VIS AUTOTARADE UX 4.2x12 TCB MARUTEX PRE	2.000	PCS	VL1019A0	POMPE DETERGENT VIBRATION	1.000	PCS	VL1047A1	PORTEGOMM E D6-EXTREMIT E D8	1.000	PCS
Code	Description	Qté	UOM																																																											
0H2202A1	SYSTEME DE LAVAGE ONE AVEC EL VAPEUR	1.000	PCS																																																											
EL1440A0	ELECTROVAN NE H2O AUTONETTOY ANTE BAIONNET	1.000	PCS																																																											
GN1526A0	O-RING D.INT6,9 SP1.8	3.000	PCS																																																											
RC1019A0	COLLIER ELASTIQUE D10 ZINGUE	12.000	PCS																																																											
RC1242A0	EXTREMITÉ FERME	2.000	PCS																																																											
RC1414A1	COLLIER A COMPRESSIO N D11,5-12,5	1.000	PCS																																																											
TB2821A0	TB2820A-L=40 MM EPDM NOI	4.000	PCS																																																											
TB3004A0	TB2820A L=550mm EPDM BLACK PIPE	1.000	PCS																																																											
TB3009B0	TB3132A-ONE OVEN WASHING INLET	1.000	PCS																																																											
TB3225B0	TB2820A-L=67 0MM EPDM NOIR	1.000	PCS																																																											
TB3614A0		1.000	PCS																																																											
VI1220A1	VIS AUTOTARADE UX 4.2x12 TCB MARUTEX PRE	2.000	PCS																																																											
VL1019A0	POMPE DETERGENT VIBRATION	1.000	PCS																																																											
VL1047A1	PORTEGOMM E D6-EXTREMIT E D8	1.000	PCS																																																											

COMPOSANT			PIÈCE DE RECHANGE																																																			
Code	Description	Image	Code	Description	Composants du kit																																																	
VL1019A	POMPE DETERGENT VIBRATION		KVL1182A	KIT SYSTEME LAVAGE ONE (SAUF 0311)	<table border="1"> <thead> <tr> <th>Code</th> <th>Description</th> <th>Qté</th> <th>UOM</th> </tr> </thead> <tbody> <tr> <td>VL1054B0</td> <td>DISTRIBUTEU R ENTREES LAVAGES ONE</td> <td>1.000</td> <td>PCS</td> </tr> <tr> <td>VL1102A1</td> <td>FILTRE DANS LA LIGNE DET+VNR BARBED 6MM</td> <td>1.000</td> <td>PCS</td> </tr> <tr> <td>VL1128A1</td> <td>CLAPET ANTIRETOUR BARBED D6</td> <td>1.000</td> <td>PCS</td> </tr> <tr> <td>VL1166A0</td> <td>RACCORD EN L BB6-AL6</td> <td>1.000</td> <td>PCS</td> </tr> <tr> <td>VL1174C0</td> <td>INJECTEUR ETALLONE D 1.2 MM</td> <td>1.000</td> <td>PCS</td> </tr> <tr> <td>VL1191A0</td> <td>DISTRIBUTEU R SORTIE LAVAGE ONE</td> <td>1.000</td> <td>PCS</td> </tr> <tr> <td>VL1214A0</td> <td>CLAPET ANTI RETOUR BB6 BAIONETTE</td> <td>1.000</td> <td>PCS</td> </tr> <tr> <td>VM2172A0</td> <td>CLIP BLOCAGE POMPE AVEC CIRCUIT</td> <td>2.000</td> <td>PCS</td> </tr> </tbody> </table>	Code	Description	Qté	UOM	VL1054B0	DISTRIBUTEU R ENTREES LAVAGES ONE	1.000	PCS	VL1102A1	FILTRE DANS LA LIGNE DET+VNR BARBED 6MM	1.000	PCS	VL1128A1	CLAPET ANTIRETOUR BARBED D6	1.000	PCS	VL1166A0	RACCORD EN L BB6-AL6	1.000	PCS	VL1174C0	INJECTEUR ETALLONE D 1.2 MM	1.000	PCS	VL1191A0	DISTRIBUTEU R SORTIE LAVAGE ONE	1.000	PCS	VL1214A0	CLAPET ANTI RETOUR BB6 BAIONETTE	1.000	PCS	VM2172A0	CLIP BLOCAGE POMPE AVEC CIRCUIT	2.000	PCS													
			Code	Description	Qté	UOM																																																
VL1054B0	DISTRIBUTEU R ENTREES LAVAGES ONE	1.000	PCS																																																			
VL1102A1	FILTRE DANS LA LIGNE DET+VNR BARBED 6MM	1.000	PCS																																																			
VL1128A1	CLAPET ANTIRETOUR BARBED D6	1.000	PCS																																																			
VL1166A0	RACCORD EN L BB6-AL6	1.000	PCS																																																			
VL1174C0	INJECTEUR ETALLONE D 1.2 MM	1.000	PCS																																																			
VL1191A0	DISTRIBUTEU R SORTIE LAVAGE ONE	1.000	PCS																																																			
VL1214A0	CLAPET ANTI RETOUR BB6 BAIONETTE	1.000	PCS																																																			
VM2172A0	CLIP BLOCAGE POMPE AVEC CIRCUIT	2.000	PCS																																																			
KVL0684A	KIT POMPE LAVAGE PLUS 2-3 BRAS >12/2019	<table border="1"> <thead> <tr> <th>Code</th> <th>Description</th> <th>Qté</th> <th>UOM</th> </tr> </thead> <tbody> <tr> <td>GN1526A0</td> <td>O-RING D.INT6.9 SP1.8</td> <td>3.000</td> <td>PCS</td> </tr> <tr> <td>RC1019A0</td> <td>COLLIER ELASTIQUE D10 ZINGUE</td> <td>4.000</td> <td>PCS</td> </tr> <tr> <td>RC1130A0</td> <td>COLLIER 130X2.6</td> <td>1.000</td> <td>PCS</td> </tr> <tr> <td>RC1131A0</td> <td>COLLIER 200X2.6 NOIR</td> <td>3.000</td> <td>PCS</td> </tr> <tr> <td>RC1242A0</td> <td>EXTREMITE FERME</td> <td>2.000</td> <td>PCS</td> </tr> <tr> <td>TB2821A0</td> <td>TB2820A-L=40 MM EPDM NOI</td> <td>3.000</td> <td>PCS</td> </tr> <tr> <td>VL1019A0</td> <td>POMPE DETERGENT VIBRATION</td> <td>1.000</td> <td>PCS</td> </tr> <tr> <td>VL1128A1</td> <td>CLAPET ANTIRETOUR BARBED D6</td> <td>1.000</td> <td>PCS</td> </tr> <tr> <td>VL1174C0</td> <td>INJECTEUR ETALLONE D 1.2 MM</td> <td>1.000</td> <td>PCS</td> </tr> <tr> <td>VL1186A0</td> <td>DISTRIBUTEU R LAVAGE PLUS 3 VOIES GICLEUR</td> <td>1.000</td> <td>PCS</td> </tr> <tr> <td>VL1190A0</td> <td>DISTRIBUTEU R ENTREE LAVAGE PLUS</td> <td>1.000</td> <td>PCS</td> </tr> <tr> <td>VM2172A0</td> <td>CLIP BLOCAGE POMPE AVEC CIRCUIT</td> <td>1.000</td> <td>PCS</td> </tr> </tbody> </table>	Code	Description	Qté	UOM	GN1526A0	O-RING D.INT6.9 SP1.8	3.000	PCS	RC1019A0	COLLIER ELASTIQUE D10 ZINGUE	4.000	PCS	RC1130A0	COLLIER 130X2.6	1.000	PCS	RC1131A0	COLLIER 200X2.6 NOIR	3.000	PCS	RC1242A0	EXTREMITE FERME	2.000	PCS	TB2821A0	TB2820A-L=40 MM EPDM NOI	3.000	PCS	VL1019A0	POMPE DETERGENT VIBRATION	1.000	PCS	VL1128A1	CLAPET ANTIRETOUR BARBED D6	1.000	PCS	VL1174C0	INJECTEUR ETALLONE D 1.2 MM	1.000	PCS	VL1186A0	DISTRIBUTEU R LAVAGE PLUS 3 VOIES GICLEUR	1.000	PCS	VL1190A0	DISTRIBUTEU R ENTREE LAVAGE PLUS	1.000	PCS	VM2172A0	CLIP BLOCAGE POMPE AVEC CIRCUIT	1.000	PCS
Code	Description	Qté	UOM																																																			
GN1526A0	O-RING D.INT6.9 SP1.8	3.000	PCS																																																			
RC1019A0	COLLIER ELASTIQUE D10 ZINGUE	4.000	PCS																																																			
RC1130A0	COLLIER 130X2.6	1.000	PCS																																																			
RC1131A0	COLLIER 200X2.6 NOIR	3.000	PCS																																																			
RC1242A0	EXTREMITE FERME	2.000	PCS																																																			
TB2821A0	TB2820A-L=40 MM EPDM NOI	3.000	PCS																																																			
VL1019A0	POMPE DETERGENT VIBRATION	1.000	PCS																																																			
VL1128A1	CLAPET ANTIRETOUR BARBED D6	1.000	PCS																																																			
VL1174C0	INJECTEUR ETALLONE D 1.2 MM	1.000	PCS																																																			
VL1186A0	DISTRIBUTEU R LAVAGE PLUS 3 VOIES GICLEUR	1.000	PCS																																																			
VL1190A0	DISTRIBUTEU R ENTREE LAVAGE PLUS	1.000	PCS																																																			
VM2172A0	CLIP BLOCAGE POMPE AVEC CIRCUIT	1.000	PCS																																																			

COMPOSANT			PIÈCE DE RECHANGE																																																																																									
Code	Description	Image	Code	Description	Composants du kit																																																																																							
VL1019A	POMPE DETERGENT VIBRATION		KVL0683A	KIT POMPE SYST LAVAGE PLUS 1BRAS>12/2019	<table border="1"> <thead> <tr> <th>Code</th> <th>Description</th> <th>Qté</th> <th>UOM</th> </tr> </thead> <tbody> <tr> <td>GN1526A0</td> <td>O-RING D.INT6.9 SP1.8</td> <td>2.000</td> <td>PCS</td> </tr> <tr> <td>RC1019A0</td> <td>COLLIER ELASTIQUE D10 ZINGUE</td> <td>4.000</td> <td>PCS</td> </tr> <tr> <td>RC1130A0</td> <td>COLLIER 130X2.6</td> <td>1.000</td> <td>PCS</td> </tr> <tr> <td>RC1131A0</td> <td>COLLIER 200X2.6 NOIR</td> <td>2.000</td> <td>PCS</td> </tr> <tr> <td>RC1242A0</td> <td>EXTREMITE FERME</td> <td>2.000</td> <td>PCS</td> </tr> <tr> <td>TB2821A0</td> <td>TB2820A-L=40 MM EPDM NOI</td> <td>3.000</td> <td>PCS</td> </tr> <tr> <td>VL1019A0</td> <td>POMPE DETERGENT VIBRATION</td> <td>1.000</td> <td>PCS</td> </tr> <tr> <td>VL1128A1</td> <td>CLAPET ANTIRETOUR BARBED D6</td> <td>1.000</td> <td>PCS</td> </tr> <tr> <td>VL1174C0</td> <td>INJECTEUR ETALLONE D 1.2 MM</td> <td>1.000</td> <td>PCS</td> </tr> <tr> <td>VL1185A0</td> <td>DISTRIBUTEU R LAVAGE PLUS 2 VOIES PLUS</td> <td>1.000</td> <td>PCS</td> </tr> <tr> <td>VL1190A0</td> <td>DISTRIBUTEU R ENTREE LAVAGE PLUS</td> <td>1.000</td> <td>PCS</td> </tr> <tr> <td>VM2172A0</td> <td>CLIP BLOCAGE POMPE AVEC CIRCUIT</td> <td>1.000</td> <td>PCS</td> </tr> </tbody> </table>	Code	Description	Qté	UOM	GN1526A0	O-RING D.INT6.9 SP1.8	2.000	PCS	RC1019A0	COLLIER ELASTIQUE D10 ZINGUE	4.000	PCS	RC1130A0	COLLIER 130X2.6	1.000	PCS	RC1131A0	COLLIER 200X2.6 NOIR	2.000	PCS	RC1242A0	EXTREMITE FERME	2.000	PCS	TB2821A0	TB2820A-L=40 MM EPDM NOI	3.000	PCS	VL1019A0	POMPE DETERGENT VIBRATION	1.000	PCS	VL1128A1	CLAPET ANTIRETOUR BARBED D6	1.000	PCS	VL1174C0	INJECTEUR ETALLONE D 1.2 MM	1.000	PCS	VL1185A0	DISTRIBUTEU R LAVAGE PLUS 2 VOIES PLUS	1.000	PCS	VL1190A0	DISTRIBUTEU R ENTREE LAVAGE PLUS	1.000	PCS	VM2172A0	CLIP BLOCAGE POMPE AVEC CIRCUIT	1.000	PCS	KVL0682A	KIT POMPE SYST LAVAGE ONE+HOTTE >12/2019	<table border="1"> <thead> <tr> <th>Code</th> <th>Description</th> <th>Qté</th> <th>UOM</th> </tr> </thead> <tbody> <tr> <td>GN1526A0</td> <td>O-RING D.INT6.9 SP1.8</td> <td>1.000</td> <td>PCS</td> </tr> <tr> <td>RC1019A0</td> <td>COLLIER ELASTIQUE D10 ZINGUE</td> <td>6.000</td> <td>PCS</td> </tr> <tr> <td>RC1242A0</td> <td>EXTREMITE FERME</td> <td>2.000</td> <td>PCS</td> </tr> <tr> <td>TB2821A0</td> <td>TB2820A-L=40 MM EPDM NOI</td> <td>3.000</td> <td>PCS</td> </tr> <tr> <td>VL1019A0</td> <td>POMPE DETERGENT VIBRATION</td> <td>1.000</td> <td>PCS</td> </tr> <tr> <td>VL1054B0</td> <td>DISTRIBUTEU R ENTREES LAVAGES ONE</td> <td>1.000</td> <td>PCS</td> </tr> <tr> <td>VL1128A1</td> <td>CLAPET ANTIRETOUR BARBED D6</td> <td>1.000</td> <td>PCS</td> </tr> </tbody> </table>	Code	Description	Qté	UOM	GN1526A0	O-RING D.INT6.9 SP1.8	1.000	PCS	RC1019A0	COLLIER ELASTIQUE D10 ZINGUE	6.000	PCS	RC1242A0	EXTREMITE FERME	2.000	PCS	TB2821A0	TB2820A-L=40 MM EPDM NOI	3.000	PCS	VL1019A0	POMPE DETERGENT VIBRATION	1.000	PCS	VL1054B0	DISTRIBUTEU R ENTREES LAVAGES ONE	1.000	PCS	VL1128A1	CLAPET ANTIRETOUR BARBED D6	1.000	PCS
			Code	Description	Qté	UOM																																																																																						
GN1526A0	O-RING D.INT6.9 SP1.8	2.000	PCS																																																																																									
RC1019A0	COLLIER ELASTIQUE D10 ZINGUE	4.000	PCS																																																																																									
RC1130A0	COLLIER 130X2.6	1.000	PCS																																																																																									
RC1131A0	COLLIER 200X2.6 NOIR	2.000	PCS																																																																																									
RC1242A0	EXTREMITE FERME	2.000	PCS																																																																																									
TB2821A0	TB2820A-L=40 MM EPDM NOI	3.000	PCS																																																																																									
VL1019A0	POMPE DETERGENT VIBRATION	1.000	PCS																																																																																									
VL1128A1	CLAPET ANTIRETOUR BARBED D6	1.000	PCS																																																																																									
VL1174C0	INJECTEUR ETALLONE D 1.2 MM	1.000	PCS																																																																																									
VL1185A0	DISTRIBUTEU R LAVAGE PLUS 2 VOIES PLUS	1.000	PCS																																																																																									
VL1190A0	DISTRIBUTEU R ENTREE LAVAGE PLUS	1.000	PCS																																																																																									
VM2172A0	CLIP BLOCAGE POMPE AVEC CIRCUIT	1.000	PCS																																																																																									
Code	Description	Qté	UOM																																																																																									
GN1526A0	O-RING D.INT6.9 SP1.8	1.000	PCS																																																																																									
RC1019A0	COLLIER ELASTIQUE D10 ZINGUE	6.000	PCS																																																																																									
RC1242A0	EXTREMITE FERME	2.000	PCS																																																																																									
TB2821A0	TB2820A-L=40 MM EPDM NOI	3.000	PCS																																																																																									
VL1019A0	POMPE DETERGENT VIBRATION	1.000	PCS																																																																																									
VL1054B0	DISTRIBUTEU R ENTREES LAVAGES ONE	1.000	PCS																																																																																									
VL1128A1	CLAPET ANTIRETOUR BARBED D6	1.000	PCS																																																																																									

COMPOSANT			PIÈCE DE RECHANGE																																																							
Code	Description	Image	Code	Description	Composants du kit																																																					
VL1019A	POMPE DETERGENT VIBRATION		KVL0682A	KIT POMPE SYST LAVAGE ONE+HOTTE >12/2019	<table border="1"> <thead> <tr> <th>Code</th> <th>Description</th> <th>Qté</th> <th>UOM</th> </tr> </thead> <tbody> <tr> <td>VL1174C0</td> <td>INJECTEUR ETALLONE D 1.2 MM</td> <td>1.000</td> <td>PCS</td> </tr> <tr> <td>VL1191A0</td> <td>DISTRIBUTEUR R SORTIE LAVAGE ONE</td> <td>1.000</td> <td>PCS</td> </tr> <tr> <td>VM2172A0</td> <td>CLIP BLOCAGE POMPE AVEC CIRCUIT</td> <td>1.000</td> <td>PCS</td> </tr> </tbody> </table>	Code	Description	Qté	UOM	VL1174C0	INJECTEUR ETALLONE D 1.2 MM	1.000	PCS	VL1191A0	DISTRIBUTEUR R SORTIE LAVAGE ONE	1.000	PCS	VM2172A0	CLIP BLOCAGE POMPE AVEC CIRCUIT	1.000	PCS																																					
			Code	Description	Qté	UOM																																																				
VL1174C0	INJECTEUR ETALLONE D 1.2 MM	1.000	PCS																																																							
VL1191A0	DISTRIBUTEUR R SORTIE LAVAGE ONE	1.000	PCS																																																							
VM2172A0	CLIP BLOCAGE POMPE AVEC CIRCUIT	1.000	PCS																																																							
KVL0001A	KIT SYSTEME LAVAGE LM TOP	<table border="1"> <thead> <tr> <th>Code</th> <th>Description</th> <th>Qté</th> <th>UOM</th> </tr> </thead> <tbody> <tr> <td>0H1226B0</td> <td>TOLE CIRCUIT LAVAGE LineMiss</td> <td>1.000</td> <td>PCS</td> </tr> <tr> <td>EL1436B0</td> <td>ELECTROVAN NE H2O JG D8-BARBED D6 VNR</td> <td>1.000</td> <td>PCS</td> </tr> <tr> <td>GN1312A0</td> <td>RUBBER CABLE-PASSI NG DE-26 Dl=15 SP=10</td> <td>1.000</td> <td>PCS</td> </tr> <tr> <td>GN1526A0</td> <td>O-RING D.INT6,9 SP1.8</td> <td>1.000</td> <td>PCS</td> </tr> <tr> <td>RC1019A0</td> <td>COLLIER ELASTIQUE D10 ZINGUE</td> <td>5.000</td> <td>PCS</td> </tr> <tr> <td>RC1242A0</td> <td>EXTREMITÉ FERME</td> <td>2.000</td> <td>PCS</td> </tr> <tr> <td>RC1381A0</td> <td>BIFILAR PIPE CLIP D10,7</td> <td>3.000</td> <td>PCS</td> </tr> <tr> <td>TB1114A1</td> <td>TB2820A-LM TOP DETERGENT PIPE COIL ROTOR</td> <td>1.000</td> <td>PCS</td> </tr> <tr> <td>TB1116A0</td> <td>TB2343A-DETE RGENT HOLD DOWN WEIGHT PIPE</td> <td>1.000</td> <td>PCS</td> </tr> <tr> <td>TB2821A0</td> <td>TB2820A-L=40 MM EPDM NOI</td> <td>1.000</td> <td>PCS</td> </tr> <tr> <td>VI1220A1</td> <td>VIS AUTOTARADE UX 4.2x12 TCB MARUTEX PRE</td> <td>1.000</td> <td>PCS</td> </tr> <tr> <td>VL1019A0</td> <td>POMPE DETERGENT VIBRATION</td> <td>1.000</td> <td>PCS</td> </tr> <tr> <td>VL1047A1</td> <td>PORTEGOMM E D6-EXTREMITÉ E D8</td> <td>1.000</td> <td>PCS</td> </tr> </tbody> </table>	Code	Description	Qté	UOM	0H1226B0	TOLE CIRCUIT LAVAGE LineMiss	1.000	PCS	EL1436B0	ELECTROVAN NE H2O JG D8-BARBED D6 VNR	1.000	PCS	GN1312A0	RUBBER CABLE-PASSI NG DE-26 Dl=15 SP=10	1.000	PCS	GN1526A0	O-RING D.INT6,9 SP1.8	1.000	PCS	RC1019A0	COLLIER ELASTIQUE D10 ZINGUE	5.000	PCS	RC1242A0	EXTREMITÉ FERME	2.000	PCS	RC1381A0	BIFILAR PIPE CLIP D10,7	3.000	PCS	TB1114A1	TB2820A-LM TOP DETERGENT PIPE COIL ROTOR	1.000	PCS	TB1116A0	TB2343A-DETE RGENT HOLD DOWN WEIGHT PIPE	1.000	PCS	TB2821A0	TB2820A-L=40 MM EPDM NOI	1.000	PCS	VI1220A1	VIS AUTOTARADE UX 4.2x12 TCB MARUTEX PRE	1.000	PCS	VL1019A0	POMPE DETERGENT VIBRATION	1.000	PCS	VL1047A1	PORTEGOMM E D6-EXTREMITÉ E D8	1.000	PCS
Code	Description	Qté	UOM																																																							
0H1226B0	TOLE CIRCUIT LAVAGE LineMiss	1.000	PCS																																																							
EL1436B0	ELECTROVAN NE H2O JG D8-BARBED D6 VNR	1.000	PCS																																																							
GN1312A0	RUBBER CABLE-PASSI NG DE-26 Dl=15 SP=10	1.000	PCS																																																							
GN1526A0	O-RING D.INT6,9 SP1.8	1.000	PCS																																																							
RC1019A0	COLLIER ELASTIQUE D10 ZINGUE	5.000	PCS																																																							
RC1242A0	EXTREMITÉ FERME	2.000	PCS																																																							
RC1381A0	BIFILAR PIPE CLIP D10,7	3.000	PCS																																																							
TB1114A1	TB2820A-LM TOP DETERGENT PIPE COIL ROTOR	1.000	PCS																																																							
TB1116A0	TB2343A-DETE RGENT HOLD DOWN WEIGHT PIPE	1.000	PCS																																																							
TB2821A0	TB2820A-L=40 MM EPDM NOI	1.000	PCS																																																							
VI1220A1	VIS AUTOTARADE UX 4.2x12 TCB MARUTEX PRE	1.000	PCS																																																							
VL1019A0	POMPE DETERGENT VIBRATION	1.000	PCS																																																							
VL1047A1	PORTEGOMM E D6-EXTREMITÉ E D8	1.000	PCS																																																							

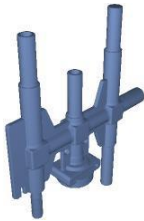
COMPOSANT			PIÈCE DE RECHANGE																																										
Code	Description	Image	Code	Description	Composants du kit																																								
VL1019A	POMPE DETERGENT VIBRATION		KVL0001A	KIT SYSTEME LAVAGE LM TOP	<table border="1"> <thead> <tr> <th>Code</th> <th>Description</th> <th>Qté</th> <th>UOM</th> </tr> </thead> <tbody> <tr> <td>VL1053B0</td> <td>DISTRIBUTEUR R SORTIE LAVAGE ONE</td> <td>1.000</td> <td>PCS</td> </tr> <tr> <td>VL1054B0</td> <td>DISTRIBUTEUR R ENTREES LAVAGES ONE</td> <td>1.000</td> <td>PCS</td> </tr> <tr> <td>VL1061A0</td> <td>HOLD DOWN WEIGHT+NET FILTER+NON- RET. V.</td> <td>1.000</td> <td>PCS</td> </tr> <tr> <td>VL1090A0</td> <td>BOUCHON UUNOX.DET& RINSE 1L</td> <td>1.000</td> <td>PCS</td> </tr> <tr> <td>VL1128A1</td> <td>CLAPET ANTIRETOUR BARBED D6</td> <td>2.000</td> <td>PCS</td> </tr> <tr> <td>VM1066A0</td> <td>SADDLE CLIP FOR CABLES PASSING</td> <td>3.000</td> <td>PCS</td> </tr> <tr> <td>VM1088A0</td> <td>COLLIER A DECLIC D7.9-D9.2 PP</td> <td>1.000</td> <td>PCS</td> </tr> <tr> <td>VM1605A0</td> <td>CLIP TWIST LOCK DIAM. 10.2-12.7 MM</td> <td>1.000</td> <td>PCS</td> </tr> <tr> <td>VM2172A0</td> <td>CLIP BLOCAGE POMPE AVEC CIRCUIT</td> <td>1.000</td> <td>PCS</td> </tr> </tbody> </table>	Code	Description	Qté	UOM	VL1053B0	DISTRIBUTEUR R SORTIE LAVAGE ONE	1.000	PCS	VL1054B0	DISTRIBUTEUR R ENTREES LAVAGES ONE	1.000	PCS	VL1061A0	HOLD DOWN WEIGHT+NET FILTER+NON- RET. V.	1.000	PCS	VL1090A0	BOUCHON UUNOX.DET& RINSE 1L	1.000	PCS	VL1128A1	CLAPET ANTIRETOUR BARBED D6	2.000	PCS	VM1066A0	SADDLE CLIP FOR CABLES PASSING	3.000	PCS	VM1088A0	COLLIER A DECLIC D7.9-D9.2 PP	1.000	PCS	VM1605A0	CLIP TWIST LOCK DIAM. 10.2-12.7 MM	1.000	PCS	VM2172A0	CLIP BLOCAGE POMPE AVEC CIRCUIT	1.000	PCS
Code	Description	Qté	UOM																																										
VL1053B0	DISTRIBUTEUR R SORTIE LAVAGE ONE	1.000	PCS																																										
VL1054B0	DISTRIBUTEUR R ENTREES LAVAGES ONE	1.000	PCS																																										
VL1061A0	HOLD DOWN WEIGHT+NET FILTER+NON- RET. V.	1.000	PCS																																										
VL1090A0	BOUCHON UUNOX.DET& RINSE 1L	1.000	PCS																																										
VL1128A1	CLAPET ANTIRETOUR BARBED D6	2.000	PCS																																										
VM1066A0	SADDLE CLIP FOR CABLES PASSING	3.000	PCS																																										
VM1088A0	COLLIER A DECLIC D7.9-D9.2 PP	1.000	PCS																																										
VM1605A0	CLIP TWIST LOCK DIAM. 10.2-12.7 MM	1.000	PCS																																										
VM2172A0	CLIP BLOCAGE POMPE AVEC CIRCUIT	1.000	PCS																																										
VL1064A	DISTRIBUTEUR SORTIES SYSTEME LAVAGE PLUS		KVL1212A	KIT SYSTEME LAVAGE PLUS COMPACT EU	<table border="1"> <thead> <tr> <th>Code</th> <th>Description</th> <th>Qté</th> <th>UOM</th> </tr> </thead> <tbody> <tr> <td>0H2428A2</td> <td>TOLE SYSTEME LAVAGE XECC PLUS</td> <td>1.000</td> <td>PCS</td> </tr> <tr> <td>EL1440A0</td> <td>ELECTROVAN NE H20 AUTONETTOY ANTE BAIONNET</td> <td>3.000</td> <td>PCS</td> </tr> <tr> <td>GN1311A0</td> <td>RUBBER CABLE-PASSI NG De=25 Di=12 Th=6.5</td> <td>1.000</td> <td>PCS</td> </tr> <tr> <td>GN1526A0</td> <td>O-RING D.INT6.9 SP1.8</td> <td>7.000</td> <td>PCS</td> </tr> <tr> <td>RC1018A0</td> <td>COLLIER ELASTIQUE D12 ZINGUE</td> <td>5.000</td> <td>PCS</td> </tr> <tr> <td>RC1019A0</td> <td>COLLIER ELASTIQUE D10 ZINGUE</td> <td>14.000</td> <td>PCS</td> </tr> <tr> <td>RC1130A0</td> <td>COLLIER 130X2.6</td> <td>1.000</td> <td>PCS</td> </tr> </tbody> </table>	Code	Description	Qté	UOM	0H2428A2	TOLE SYSTEME LAVAGE XECC PLUS	1.000	PCS	EL1440A0	ELECTROVAN NE H20 AUTONETTOY ANTE BAIONNET	3.000	PCS	GN1311A0	RUBBER CABLE-PASSI NG De=25 Di=12 Th=6.5	1.000	PCS	GN1526A0	O-RING D.INT6.9 SP1.8	7.000	PCS	RC1018A0	COLLIER ELASTIQUE D12 ZINGUE	5.000	PCS	RC1019A0	COLLIER ELASTIQUE D10 ZINGUE	14.000	PCS	RC1130A0	COLLIER 130X2.6	1.000	PCS								
Code	Description	Qté	UOM																																										
0H2428A2	TOLE SYSTEME LAVAGE XECC PLUS	1.000	PCS																																										
EL1440A0	ELECTROVAN NE H20 AUTONETTOY ANTE BAIONNET	3.000	PCS																																										
GN1311A0	RUBBER CABLE-PASSI NG De=25 Di=12 Th=6.5	1.000	PCS																																										
GN1526A0	O-RING D.INT6.9 SP1.8	7.000	PCS																																										
RC1018A0	COLLIER ELASTIQUE D12 ZINGUE	5.000	PCS																																										
RC1019A0	COLLIER ELASTIQUE D10 ZINGUE	14.000	PCS																																										
RC1130A0	COLLIER 130X2.6	1.000	PCS																																										

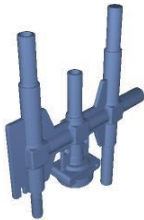
COMPOSANT			PIÈCE DE RECHANGE																																																																																		
Code	Description	Image	Code	Description	Composants du kit																																																																																
VL1064A	DISTRIBUTEUR SORTIES SYSTEME LAVAGE PLUS		KVL1212A	KIT SYSTEME LAVAGE PLUS COMPACT EU	<table border="1"> <thead> <tr> <th>Code</th> <th>Description</th> <th>Qté</th> <th>UOM</th> </tr> </thead> <tbody> <tr> <td>RC1131A0</td> <td>COLLIER 200X2.6 NOIR</td> <td>1.000</td> <td>PCS</td> </tr> <tr> <td>RC1242A0</td> <td>EXTREMITE FERME</td> <td>2.000</td> <td>PCS</td> </tr> <tr> <td>RC1356A0</td> <td>RACCORD DROIT FIL FEMELLE 8X1/4 BSP</td> <td>1.000</td> <td>PCS</td> </tr> <tr> <td>RC1414A1</td> <td>COLLIER A COMPRESSIO N D11.5-12.5</td> <td>4.000</td> <td>PCS</td> </tr> <tr> <td>TB2821A0</td> <td>TB2820A-L=40 MM EPDM NOI</td> <td>6.000</td> <td>PCS</td> </tr> <tr> <td>TB3004A0</td> <td>TB2820A L=550mm EPDM BLACK PIPE</td> <td>2.000</td> <td>PCS</td> </tr> <tr> <td>TB3005B0</td> <td>TB3132A L=550mm EPDM WHITE-BLUE PIPE</td> <td>1.000</td> <td>PCS</td> </tr> <tr> <td>TB3252A0</td> <td>TB3252A0</td> <td>1.000</td> <td>PCS</td> </tr> <tr> <td>TB3469A0</td> <td></td> <td>1.000</td> <td>PCS</td> </tr> <tr> <td>VI1220A1</td> <td>VIS AUTOTARADE UX 4.2x12 TCB MARUTEX PRE</td> <td>3.000</td> <td>PCS</td> </tr> <tr> <td>VL1019A0</td> <td>POMPE DETERGENT VIBRATION</td> <td>1.000</td> <td>PCS</td> </tr> <tr> <td>VL1047A1</td> <td>PORTEGOMM E D6-EXTREMIT E D8</td> <td>1.000</td> <td>PCS</td> </tr> <tr> <td>VL1054B0</td> <td>DISTRIBUTEU R ENTREES LAVAGES ONE</td> <td>1.000</td> <td>PCS</td> </tr> <tr> <td>VL1065A1</td> <td>PRESSOSTAT N.O. 1/4 M CIL</td> <td>1.000</td> <td>PCS</td> </tr> <tr> <td>VL1102A1</td> <td>FILTRE DANS LA LIGNE DET+VNR BARBED 6MM</td> <td>1.000</td> <td>PCS</td> </tr> <tr> <td>VL1127A1</td> <td>RACCORD T BARBED 6mm</td> <td>1.000</td> <td>PCS</td> </tr> <tr> <td>VL1128A1</td> <td>CLAPET ANTIRETOUR BARBED D6</td> <td>2.000</td> <td>PCS</td> </tr> <tr> <td>VL1165A0</td> <td>RACCORD DROIT BAM-BB6</td> <td>1.000</td> <td>PCS</td> </tr> <tr> <td>VL1166A0</td> <td>RACCORD EN L BB6-AL6</td> <td>3.000</td> <td>PCS</td> </tr> </tbody> </table>	Code	Description	Qté	UOM	RC1131A0	COLLIER 200X2.6 NOIR	1.000	PCS	RC1242A0	EXTREMITE FERME	2.000	PCS	RC1356A0	RACCORD DROIT FIL FEMELLE 8X1/4 BSP	1.000	PCS	RC1414A1	COLLIER A COMPRESSIO N D11.5-12.5	4.000	PCS	TB2821A0	TB2820A-L=40 MM EPDM NOI	6.000	PCS	TB3004A0	TB2820A L=550mm EPDM BLACK PIPE	2.000	PCS	TB3005B0	TB3132A L=550mm EPDM WHITE-BLUE PIPE	1.000	PCS	TB3252A0	TB3252A0	1.000	PCS	TB3469A0		1.000	PCS	VI1220A1	VIS AUTOTARADE UX 4.2x12 TCB MARUTEX PRE	3.000	PCS	VL1019A0	POMPE DETERGENT VIBRATION	1.000	PCS	VL1047A1	PORTEGOMM E D6-EXTREMIT E D8	1.000	PCS	VL1054B0	DISTRIBUTEU R ENTREES LAVAGES ONE	1.000	PCS	VL1065A1	PRESSOSTAT N.O. 1/4 M CIL	1.000	PCS	VL1102A1	FILTRE DANS LA LIGNE DET+VNR BARBED 6MM	1.000	PCS	VL1127A1	RACCORD T BARBED 6mm	1.000	PCS	VL1128A1	CLAPET ANTIRETOUR BARBED D6	2.000	PCS	VL1165A0	RACCORD DROIT BAM-BB6	1.000	PCS	VL1166A0	RACCORD EN L BB6-AL6	3.000	PCS
Code	Description	Qté	UOM																																																																																		
RC1131A0	COLLIER 200X2.6 NOIR	1.000	PCS																																																																																		
RC1242A0	EXTREMITE FERME	2.000	PCS																																																																																		
RC1356A0	RACCORD DROIT FIL FEMELLE 8X1/4 BSP	1.000	PCS																																																																																		
RC1414A1	COLLIER A COMPRESSIO N D11.5-12.5	4.000	PCS																																																																																		
TB2821A0	TB2820A-L=40 MM EPDM NOI	6.000	PCS																																																																																		
TB3004A0	TB2820A L=550mm EPDM BLACK PIPE	2.000	PCS																																																																																		
TB3005B0	TB3132A L=550mm EPDM WHITE-BLUE PIPE	1.000	PCS																																																																																		
TB3252A0	TB3252A0	1.000	PCS																																																																																		
TB3469A0		1.000	PCS																																																																																		
VI1220A1	VIS AUTOTARADE UX 4.2x12 TCB MARUTEX PRE	3.000	PCS																																																																																		
VL1019A0	POMPE DETERGENT VIBRATION	1.000	PCS																																																																																		
VL1047A1	PORTEGOMM E D6-EXTREMIT E D8	1.000	PCS																																																																																		
VL1054B0	DISTRIBUTEU R ENTREES LAVAGES ONE	1.000	PCS																																																																																		
VL1065A1	PRESSOSTAT N.O. 1/4 M CIL	1.000	PCS																																																																																		
VL1102A1	FILTRE DANS LA LIGNE DET+VNR BARBED 6MM	1.000	PCS																																																																																		
VL1127A1	RACCORD T BARBED 6mm	1.000	PCS																																																																																		
VL1128A1	CLAPET ANTIRETOUR BARBED D6	2.000	PCS																																																																																		
VL1165A0	RACCORD DROIT BAM-BB6	1.000	PCS																																																																																		
VL1166A0	RACCORD EN L BB6-AL6	3.000	PCS																																																																																		

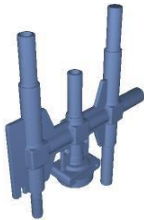

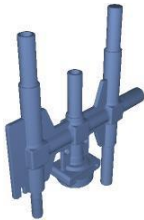
COMPOSANT			PIÈCE DE RECHANGE																																																																			
Code	Description	Image	Code	Description	Composants du kit																																																																	
VL1064A	DISTRIBUTEUR SORTIES SYSTEME LAVAGE PLUS		KVL1212A	KIT SYSTEME LAVAGE PLUS COMPACT EU	<table border="1"> <thead> <tr> <th>Code</th> <th>Description</th> <th>Qté</th> <th>UOM</th> </tr> </thead> <tbody> <tr> <td>VL1174C0</td> <td>INJECTEUR ETALLONE D 1.2 MM</td> <td>1.000</td> <td>PCS</td> </tr> <tr> <td>VL1185A0</td> <td>DISTRIBUTEU R LAVAGE PLUS 2 VOIES PLUS</td> <td>1.000</td> <td>PCS</td> </tr> <tr> <td>VM2172A0</td> <td>CLIP BLOCAGE POMPE AVEC CIRCUIT</td> <td>3.000</td> <td>PCS</td> </tr> </tbody> </table>	Code	Description	Qté	UOM	VL1174C0	INJECTEUR ETALLONE D 1.2 MM	1.000	PCS	VL1185A0	DISTRIBUTEU R LAVAGE PLUS 2 VOIES PLUS	1.000	PCS	VM2172A0	CLIP BLOCAGE POMPE AVEC CIRCUIT	3.000	PCS																																																	
			Code	Description	Qté	UOM																																																																
VL1174C0	INJECTEUR ETALLONE D 1.2 MM	1.000	PCS																																																																			
VL1185A0	DISTRIBUTEU R LAVAGE PLUS 2 VOIES PLUS	1.000	PCS																																																																			
VM2172A0	CLIP BLOCAGE POMPE AVEC CIRCUIT	3.000	PCS																																																																			
KVL1187A	KIT SYSTEME LAVAGE 3 TOURNIQUETS EU	<table border="1"> <thead> <tr> <th>Code</th> <th>Description</th> <th>Qté</th> <th>UOM</th> </tr> </thead> <tbody> <tr> <td>0H2354A1</td> <td>TOLE SYSTEME LAVAGE PLUS XEVC-XEVL</td> <td>1.000</td> <td>PCS</td> </tr> <tr> <td>EL1440A0</td> <td>ELECTROVAN NE H20 AUTONETTOY ANTE BAIONNET</td> <td>4.000</td> <td>PCS</td> </tr> <tr> <td>GN1526A0</td> <td>O-RING D.INT6.9 SP1.8</td> <td>9.000</td> <td>PCS</td> </tr> <tr> <td>RC1018A0</td> <td>COLLIER ELASTIQUE D12 ZINGUE</td> <td>11.000</td> <td>PCS</td> </tr> <tr> <td>RC1019A0</td> <td>COLLIER ELASTIQUE D10 ZINGUE</td> <td>14.000</td> <td>PCS</td> </tr> <tr> <td>RC1130A0</td> <td>COLLIER 130X2.6</td> <td>1.000</td> <td>PCS</td> </tr> <tr> <td>RC1131A0</td> <td>COLLIER 200X2.6 NOIR</td> <td>3.000</td> <td>PCS</td> </tr> <tr> <td>RC1242A0</td> <td>EXTREMITE FERME</td> <td>2.000</td> <td>PCS</td> </tr> <tr> <td>RC1356A0</td> <td>RACCORD DROIT FIL FEMELLE 8X1/4 BSP</td> <td>1.000</td> <td>PCS</td> </tr> <tr> <td>RC1414A1</td> <td>COLLIER A COMPRESSIO N D11.5-12.5</td> <td>1.000</td> <td>PCS</td> </tr> <tr> <td>TB2652A0</td> <td></td> <td>1.000</td> <td>PCS</td> </tr> <tr> <td>TB2677A0</td> <td></td> <td>1.000</td> <td>PCS</td> </tr> <tr> <td>TB2821A0</td> <td>TB2820A-L=40 MM EPDM NOI</td> <td>4.000</td> <td>PCS</td> </tr> <tr> <td>TB3004A0</td> <td>TB2820A L=550mm EPDM BLACK PIPE</td> <td>2.000</td> <td>PCS</td> </tr> <tr> <td>TB3024C0</td> <td></td> <td>3.000</td> <td>PCS</td> </tr> <tr> <td>TB3226A0</td> <td></td> <td>1.000</td> <td>PCS</td> </tr> </tbody> </table>	Code	Description	Qté	UOM	0H2354A1	TOLE SYSTEME LAVAGE PLUS XEVC-XEVL	1.000	PCS	EL1440A0	ELECTROVAN NE H20 AUTONETTOY ANTE BAIONNET	4.000	PCS	GN1526A0	O-RING D.INT6.9 SP1.8	9.000	PCS	RC1018A0	COLLIER ELASTIQUE D12 ZINGUE	11.000	PCS	RC1019A0	COLLIER ELASTIQUE D10 ZINGUE	14.000	PCS	RC1130A0	COLLIER 130X2.6	1.000	PCS	RC1131A0	COLLIER 200X2.6 NOIR	3.000	PCS	RC1242A0	EXTREMITE FERME	2.000	PCS	RC1356A0	RACCORD DROIT FIL FEMELLE 8X1/4 BSP	1.000	PCS	RC1414A1	COLLIER A COMPRESSIO N D11.5-12.5	1.000	PCS	TB2652A0		1.000	PCS	TB2677A0		1.000	PCS	TB2821A0	TB2820A-L=40 MM EPDM NOI	4.000	PCS	TB3004A0	TB2820A L=550mm EPDM BLACK PIPE	2.000	PCS	TB3024C0		3.000	PCS	TB3226A0		1.000	PCS
Code	Description	Qté	UOM																																																																			
0H2354A1	TOLE SYSTEME LAVAGE PLUS XEVC-XEVL	1.000	PCS																																																																			
EL1440A0	ELECTROVAN NE H20 AUTONETTOY ANTE BAIONNET	4.000	PCS																																																																			
GN1526A0	O-RING D.INT6.9 SP1.8	9.000	PCS																																																																			
RC1018A0	COLLIER ELASTIQUE D12 ZINGUE	11.000	PCS																																																																			
RC1019A0	COLLIER ELASTIQUE D10 ZINGUE	14.000	PCS																																																																			
RC1130A0	COLLIER 130X2.6	1.000	PCS																																																																			
RC1131A0	COLLIER 200X2.6 NOIR	3.000	PCS																																																																			
RC1242A0	EXTREMITE FERME	2.000	PCS																																																																			
RC1356A0	RACCORD DROIT FIL FEMELLE 8X1/4 BSP	1.000	PCS																																																																			
RC1414A1	COLLIER A COMPRESSIO N D11.5-12.5	1.000	PCS																																																																			
TB2652A0		1.000	PCS																																																																			
TB2677A0		1.000	PCS																																																																			
TB2821A0	TB2820A-L=40 MM EPDM NOI	4.000	PCS																																																																			
TB3004A0	TB2820A L=550mm EPDM BLACK PIPE	2.000	PCS																																																																			
TB3024C0		3.000	PCS																																																																			
TB3226A0		1.000	PCS																																																																			

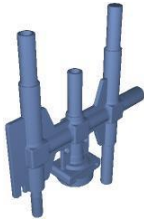
COMPOSANT			PIÈCE DE RECHANGE																																																																										
Code	Description	Image	Code	Description	Composants du kit																																																																								
VL1064A	DISTRIBUTEUR SORTIES SYSTEME LAVAGE PLUS		KVL1187A	KIT SYSTEME LAVAGE 3 TOURNIQUETS EU	<table border="1"> <thead> <tr> <th>Code</th> <th>Description</th> <th>Qté</th> <th>UOM</th> </tr> </thead> <tbody> <tr> <td>TB3440A0</td> <td>TB3132A L=1050mm EPDM WHITE-BLUE PIPE</td> <td>1.000</td> <td>PCS</td> </tr> <tr> <td>TB3614A0</td> <td></td> <td>1.000</td> <td>PCS</td> </tr> <tr> <td>VI1220A1</td> <td>VIS AUTOTARADE UX 4.2x12 TCB MARUTEX PRE</td> <td>1.000</td> <td>PCS</td> </tr> <tr> <td>VL1019A0</td> <td>POMPE DETERGENT VIBRATION</td> <td>1.000</td> <td>PCS</td> </tr> <tr> <td>VL1047A1</td> <td>PORTEGOMM E D6-EXTREMIT E D8</td> <td>1.000</td> <td>PCS</td> </tr> <tr> <td>VL1065A1</td> <td>PRESSOSTAT N.O. 1/4 M CIL</td> <td>1.000</td> <td>PCS</td> </tr> <tr> <td>VL1102A1</td> <td>FILTRE DANS LA LIGNE DET+VNR BARBED 6MM</td> <td>1.000</td> <td>PCS</td> </tr> <tr> <td>VL1127A1</td> <td>RACCORD T BARBED 6mm</td> <td>2.000</td> <td>PCS</td> </tr> <tr> <td>VL1128A1</td> <td>CLAPET ANTIRETOUR BARBED D6</td> <td>2.000</td> <td>PCS</td> </tr> <tr> <td>VL1166A0</td> <td>RACCORD EN L BB6-AL6</td> <td>4.000</td> <td>PCS</td> </tr> <tr> <td>VL1167A2</td> <td>REDUCTEUR DE DEBIT 3 BRAS DE LAVAGE GN21</td> <td>1.000</td> <td>PCS</td> </tr> <tr> <td>VL1174C0</td> <td>INJECTEUR ETALLONE D 1.2 MM</td> <td>1.000</td> <td>PCS</td> </tr> <tr> <td>VL1186A0</td> <td>DISTRIBUTEUR R LAVAGE PLUS 3 VOIES GICLEUR</td> <td>1.000</td> <td>PCS</td> </tr> <tr> <td>VL1190A0</td> <td>DISTRIBUTEUR R ENTREE LAVAGE PLUS</td> <td>1.000</td> <td>PCS</td> </tr> <tr> <td>VL1214A0</td> <td>CLAPET ANTI RETOUR BB6 BAIONETTE</td> <td>1.000</td> <td>PCS</td> </tr> <tr> <td>VM1605A0</td> <td>CLIP TWIST LOCK DIAM. 10,2-12,7 MM</td> <td>3.000</td> <td>PCS</td> </tr> <tr> <td>VM2172A0</td> <td>CLIP BLOCAGE POMPE AVEC CIRCUIT</td> <td>5.000</td> <td>PCS</td> </tr> </tbody> </table>	Code	Description	Qté	UOM	TB3440A0	TB3132A L=1050mm EPDM WHITE-BLUE PIPE	1.000	PCS	TB3614A0		1.000	PCS	VI1220A1	VIS AUTOTARADE UX 4.2x12 TCB MARUTEX PRE	1.000	PCS	VL1019A0	POMPE DETERGENT VIBRATION	1.000	PCS	VL1047A1	PORTEGOMM E D6-EXTREMIT E D8	1.000	PCS	VL1065A1	PRESSOSTAT N.O. 1/4 M CIL	1.000	PCS	VL1102A1	FILTRE DANS LA LIGNE DET+VNR BARBED 6MM	1.000	PCS	VL1127A1	RACCORD T BARBED 6mm	2.000	PCS	VL1128A1	CLAPET ANTIRETOUR BARBED D6	2.000	PCS	VL1166A0	RACCORD EN L BB6-AL6	4.000	PCS	VL1167A2	REDUCTEUR DE DEBIT 3 BRAS DE LAVAGE GN21	1.000	PCS	VL1174C0	INJECTEUR ETALLONE D 1.2 MM	1.000	PCS	VL1186A0	DISTRIBUTEUR R LAVAGE PLUS 3 VOIES GICLEUR	1.000	PCS	VL1190A0	DISTRIBUTEUR R ENTREE LAVAGE PLUS	1.000	PCS	VL1214A0	CLAPET ANTI RETOUR BB6 BAIONETTE	1.000	PCS	VM1605A0	CLIP TWIST LOCK DIAM. 10,2-12,7 MM	3.000	PCS	VM2172A0	CLIP BLOCAGE POMPE AVEC CIRCUIT	5.000	PCS
Code	Description	Qté	UOM																																																																										
TB3440A0	TB3132A L=1050mm EPDM WHITE-BLUE PIPE	1.000	PCS																																																																										
TB3614A0		1.000	PCS																																																																										
VI1220A1	VIS AUTOTARADE UX 4.2x12 TCB MARUTEX PRE	1.000	PCS																																																																										
VL1019A0	POMPE DETERGENT VIBRATION	1.000	PCS																																																																										
VL1047A1	PORTEGOMM E D6-EXTREMIT E D8	1.000	PCS																																																																										
VL1065A1	PRESSOSTAT N.O. 1/4 M CIL	1.000	PCS																																																																										
VL1102A1	FILTRE DANS LA LIGNE DET+VNR BARBED 6MM	1.000	PCS																																																																										
VL1127A1	RACCORD T BARBED 6mm	2.000	PCS																																																																										
VL1128A1	CLAPET ANTIRETOUR BARBED D6	2.000	PCS																																																																										
VL1166A0	RACCORD EN L BB6-AL6	4.000	PCS																																																																										
VL1167A2	REDUCTEUR DE DEBIT 3 BRAS DE LAVAGE GN21	1.000	PCS																																																																										
VL1174C0	INJECTEUR ETALLONE D 1.2 MM	1.000	PCS																																																																										
VL1186A0	DISTRIBUTEUR R LAVAGE PLUS 3 VOIES GICLEUR	1.000	PCS																																																																										
VL1190A0	DISTRIBUTEUR R ENTREE LAVAGE PLUS	1.000	PCS																																																																										
VL1214A0	CLAPET ANTI RETOUR BB6 BAIONETTE	1.000	PCS																																																																										
VM1605A0	CLIP TWIST LOCK DIAM. 10,2-12,7 MM	3.000	PCS																																																																										
VM2172A0	CLIP BLOCAGE POMPE AVEC CIRCUIT	5.000	PCS																																																																										

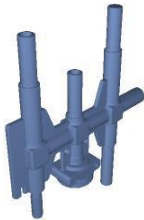

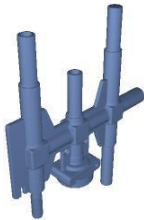

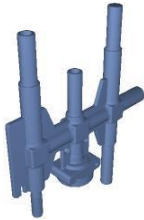
COMPOSANT			PIÈCE DE RECHANGE																																																																										
Code	Description	Image	Code	Description	Composants du kit																																																																								
VL1064A	DISTRIBUTEUR SORTIES SYSTEME LAVAGE PLUS		KVL1184A	KIT SYSTEME LAVAGE 2 TOURNIQUETS EU	<table border="1"> <thead> <tr> <th>Code</th> <th>Description</th> <th>Qté</th> <th>UOM</th> </tr> </thead> <tbody> <tr> <td>0H2354A1</td> <td>TOLE SYSTEME LAVAGE PLUS XEVC-XEVL</td> <td>1.000</td> <td>PCS</td> </tr> <tr> <td>EL1440A0</td> <td>ELECTROVAN NE H2O AUTONETTOY ANTE BAIONNET</td> <td>4.000</td> <td>PCS</td> </tr> <tr> <td>GN1526A0</td> <td>O-RING D.INT6.9 SP1.8</td> <td>9.000</td> <td>PCS</td> </tr> <tr> <td>RC1018A0</td> <td>COLLIER ELASTIQUE D12 ZINGUE</td> <td>2.000</td> <td>PCS</td> </tr> <tr> <td>RC1019A0</td> <td>COLLIER ELASTIQUE D10 ZINGUE</td> <td>13.000</td> <td>PCS</td> </tr> <tr> <td>RC1130A0</td> <td>COLLIER 130X2.6</td> <td>1.000</td> <td>PCS</td> </tr> <tr> <td>RC1131A0</td> <td>COLLIER 200X2.6 NOIR</td> <td>3.000</td> <td>PCS</td> </tr> <tr> <td>RC1242A0</td> <td>EXTREMITE FERME</td> <td>2.000</td> <td>PCS</td> </tr> <tr> <td>RC1356A0</td> <td>RACCORD DROIT FIL FEMELLE 8X1/4 BSP</td> <td>1.000</td> <td>PCS</td> </tr> <tr> <td>RC1414A1</td> <td>COLLIER A COMPRESSIO N D11.5-12.5</td> <td>1.000</td> <td>PCS</td> </tr> <tr> <td>TB2821A0</td> <td>TB2820A-L=40 MM EPDM NOI</td> <td>4.000</td> <td>PCS</td> </tr> <tr> <td>TB2994A0</td> <td>TB2820A0-TUY AU DETERGENT CAMPANAS 1</td> <td>1.000</td> <td>PCS</td> </tr> <tr> <td>TB3004A0</td> <td>TB2820A L=550mm EPDM BLACK PIPE</td> <td>2.000</td> <td>PCS</td> </tr> <tr> <td>TB3005B0</td> <td>TB3132A L=550mm EPDM WHITE-BLUE PIPE</td> <td>1.000</td> <td>PCS</td> </tr> <tr> <td>TB3440A0</td> <td>TB3132A L=1050mm EPDM WHITE-BLUE PIPE</td> <td>1.000</td> <td>PCS</td> </tr> <tr> <td>TB3614A0</td> <td></td> <td>1.000</td> <td>PCS</td> </tr> <tr> <td>VI1220A1</td> <td>VIS AUTOTARADE UX 4.2x12 TCB MARUTEX PRE</td> <td>1.000</td> <td>PCS</td> </tr> </tbody> </table>	Code	Description	Qté	UOM	0H2354A1	TOLE SYSTEME LAVAGE PLUS XEVC-XEVL	1.000	PCS	EL1440A0	ELECTROVAN NE H2O AUTONETTOY ANTE BAIONNET	4.000	PCS	GN1526A0	O-RING D.INT6.9 SP1.8	9.000	PCS	RC1018A0	COLLIER ELASTIQUE D12 ZINGUE	2.000	PCS	RC1019A0	COLLIER ELASTIQUE D10 ZINGUE	13.000	PCS	RC1130A0	COLLIER 130X2.6	1.000	PCS	RC1131A0	COLLIER 200X2.6 NOIR	3.000	PCS	RC1242A0	EXTREMITE FERME	2.000	PCS	RC1356A0	RACCORD DROIT FIL FEMELLE 8X1/4 BSP	1.000	PCS	RC1414A1	COLLIER A COMPRESSIO N D11.5-12.5	1.000	PCS	TB2821A0	TB2820A-L=40 MM EPDM NOI	4.000	PCS	TB2994A0	TB2820A0-TUY AU DETERGENT CAMPANAS 1	1.000	PCS	TB3004A0	TB2820A L=550mm EPDM BLACK PIPE	2.000	PCS	TB3005B0	TB3132A L=550mm EPDM WHITE-BLUE PIPE	1.000	PCS	TB3440A0	TB3132A L=1050mm EPDM WHITE-BLUE PIPE	1.000	PCS	TB3614A0		1.000	PCS	VI1220A1	VIS AUTOTARADE UX 4.2x12 TCB MARUTEX PRE	1.000	PCS
Code	Description	Qté	UOM																																																																										
0H2354A1	TOLE SYSTEME LAVAGE PLUS XEVC-XEVL	1.000	PCS																																																																										
EL1440A0	ELECTROVAN NE H2O AUTONETTOY ANTE BAIONNET	4.000	PCS																																																																										
GN1526A0	O-RING D.INT6.9 SP1.8	9.000	PCS																																																																										
RC1018A0	COLLIER ELASTIQUE D12 ZINGUE	2.000	PCS																																																																										
RC1019A0	COLLIER ELASTIQUE D10 ZINGUE	13.000	PCS																																																																										
RC1130A0	COLLIER 130X2.6	1.000	PCS																																																																										
RC1131A0	COLLIER 200X2.6 NOIR	3.000	PCS																																																																										
RC1242A0	EXTREMITE FERME	2.000	PCS																																																																										
RC1356A0	RACCORD DROIT FIL FEMELLE 8X1/4 BSP	1.000	PCS																																																																										
RC1414A1	COLLIER A COMPRESSIO N D11.5-12.5	1.000	PCS																																																																										
TB2821A0	TB2820A-L=40 MM EPDM NOI	4.000	PCS																																																																										
TB2994A0	TB2820A0-TUY AU DETERGENT CAMPANAS 1	1.000	PCS																																																																										
TB3004A0	TB2820A L=550mm EPDM BLACK PIPE	2.000	PCS																																																																										
TB3005B0	TB3132A L=550mm EPDM WHITE-BLUE PIPE	1.000	PCS																																																																										
TB3440A0	TB3132A L=1050mm EPDM WHITE-BLUE PIPE	1.000	PCS																																																																										
TB3614A0		1.000	PCS																																																																										
VI1220A1	VIS AUTOTARADE UX 4.2x12 TCB MARUTEX PRE	1.000	PCS																																																																										

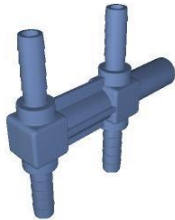

COMPOSANT			PIÈCE DE RECHANGE																																																																													
Code	Description	Image	Code	Description	Composants du kit																																																																											
VL1064A	DISTRIBUTEUR SORTIES SYSTEME LAVAGE PLUS		KVL1184A	KIT SYSTEME LAVAGE 2 TOURNIQUETS EU	<table border="1"> <thead> <tr> <th>Code</th> <th>Description</th> <th>Qté</th> <th>UOM</th> </tr> </thead> <tbody> <tr> <td>VL1019A0</td> <td>POMPE DETERGENT VIBRATION</td> <td>1.000</td> <td>PCS</td> </tr> <tr> <td>VL1047A1</td> <td>PORTEGOMM E D6-EXTREMIT E D8</td> <td>1.000</td> <td>PCS</td> </tr> <tr> <td>VL1065A1</td> <td>PRESSOSTAT N.O. 1/4 M.CIL</td> <td>1.000</td> <td>PCS</td> </tr> <tr> <td>VL1102A1</td> <td>FILTRE DANS LA LIGNE DET+VNR BARBED 6MM</td> <td>1.000</td> <td>PCS</td> </tr> <tr> <td>VL1128A1</td> <td>CLAPET ANTIRETOUR BARBED D6</td> <td>1.000</td> <td>PCS</td> </tr> <tr> <td>VL1166A0</td> <td>RACCORD EN L BB6-AL6</td> <td>4.000</td> <td>PCS</td> </tr> <tr> <td>VL1174C0</td> <td>INJECTEUR ETALLONE D 1.2 MM</td> <td>1.000</td> <td>PCS</td> </tr> <tr> <td>VL1186A0</td> <td>DISTRIBUTEU R LAVAGE PLUS 3 VOIES GICLÉUR</td> <td>1.000</td> <td>PCS</td> </tr> <tr> <td>VL1190A0</td> <td>DISTRIBUTEU R ENTREE LAVAGE PLUS</td> <td>1.000</td> <td>PCS</td> </tr> <tr> <td>VL1214A0</td> <td>CLAPET ANTI RETOUR BB6 BAIONETTE</td> <td>1.000</td> <td>PCS</td> </tr> <tr> <td>VM1605A0</td> <td>CLIP TWIST LOCK DIAM. 10,2-12,7 MM</td> <td>3.000</td> <td>PCS</td> </tr> <tr> <td>VM2172A0</td> <td>CLIP BLOCAGE POMPE AVEC CIRCUIT</td> <td>5.000</td> <td>PCS</td> </tr> </tbody> </table>	Code	Description	Qté	UOM	VL1019A0	POMPE DETERGENT VIBRATION	1.000	PCS	VL1047A1	PORTEGOMM E D6-EXTREMIT E D8	1.000	PCS	VL1065A1	PRESSOSTAT N.O. 1/4 M.CIL	1.000	PCS	VL1102A1	FILTRE DANS LA LIGNE DET+VNR BARBED 6MM	1.000	PCS	VL1128A1	CLAPET ANTIRETOUR BARBED D6	1.000	PCS	VL1166A0	RACCORD EN L BB6-AL6	4.000	PCS	VL1174C0	INJECTEUR ETALLONE D 1.2 MM	1.000	PCS	VL1186A0	DISTRIBUTEU R LAVAGE PLUS 3 VOIES GICLÉUR	1.000	PCS	VL1190A0	DISTRIBUTEU R ENTREE LAVAGE PLUS	1.000	PCS	VL1214A0	CLAPET ANTI RETOUR BB6 BAIONETTE	1.000	PCS	VM1605A0	CLIP TWIST LOCK DIAM. 10,2-12,7 MM	3.000	PCS	VM2172A0	CLIP BLOCAGE POMPE AVEC CIRCUIT	5.000	PCS	KVL1183A	KIT SYSTEME LAVAGE PLUS 1 BRAS	<table border="1"> <thead> <tr> <th>Code</th> <th>Description</th> <th>Qté</th> <th>UOM</th> </tr> </thead> <tbody> <tr> <td>0H2354A1</td> <td>TOLE SYSTEME LAVAGE PLUS XEVC-XEVL</td> <td>1.000</td> <td>PCS</td> </tr> <tr> <td>EL1440A0</td> <td>ELECTROVAN NE H20 AUTONETTOY ANTE BAIONNET</td> <td>3.000</td> <td>PCS</td> </tr> <tr> <td>GN1526A0</td> <td>O-RING D.INT6.9 SP1.8</td> <td>7.000</td> <td>PCS</td> </tr> <tr> <td>RC1018A0</td> <td>COLLIER ELASTIQUE D12 ZINGUE</td> <td>1.000</td> <td>PCS</td> </tr> </tbody> </table>	Code	Description	Qté	UOM	0H2354A1	TOLE SYSTEME LAVAGE PLUS XEVC-XEVL	1.000	PCS	EL1440A0	ELECTROVAN NE H20 AUTONETTOY ANTE BAIONNET	3.000	PCS	GN1526A0	O-RING D.INT6.9 SP1.8	7.000	PCS	RC1018A0	COLLIER ELASTIQUE D12 ZINGUE	1.000	PCS
			Code	Description	Qté	UOM																																																																										
VL1019A0	POMPE DETERGENT VIBRATION	1.000	PCS																																																																													
VL1047A1	PORTEGOMM E D6-EXTREMIT E D8	1.000	PCS																																																																													
VL1065A1	PRESSOSTAT N.O. 1/4 M.CIL	1.000	PCS																																																																													
VL1102A1	FILTRE DANS LA LIGNE DET+VNR BARBED 6MM	1.000	PCS																																																																													
VL1128A1	CLAPET ANTIRETOUR BARBED D6	1.000	PCS																																																																													
VL1166A0	RACCORD EN L BB6-AL6	4.000	PCS																																																																													
VL1174C0	INJECTEUR ETALLONE D 1.2 MM	1.000	PCS																																																																													
VL1186A0	DISTRIBUTEU R LAVAGE PLUS 3 VOIES GICLÉUR	1.000	PCS																																																																													
VL1190A0	DISTRIBUTEU R ENTREE LAVAGE PLUS	1.000	PCS																																																																													
VL1214A0	CLAPET ANTI RETOUR BB6 BAIONETTE	1.000	PCS																																																																													
VM1605A0	CLIP TWIST LOCK DIAM. 10,2-12,7 MM	3.000	PCS																																																																													
VM2172A0	CLIP BLOCAGE POMPE AVEC CIRCUIT	5.000	PCS																																																																													
Code	Description	Qté	UOM																																																																													
0H2354A1	TOLE SYSTEME LAVAGE PLUS XEVC-XEVL	1.000	PCS																																																																													
EL1440A0	ELECTROVAN NE H20 AUTONETTOY ANTE BAIONNET	3.000	PCS																																																																													
GN1526A0	O-RING D.INT6.9 SP1.8	7.000	PCS																																																																													
RC1018A0	COLLIER ELASTIQUE D12 ZINGUE	1.000	PCS																																																																													

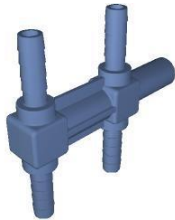

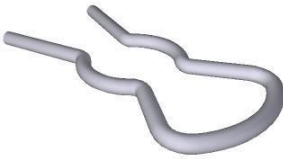

COMPOSANT			PIÈCE DE RECHANGE																																																																																		
Code	Description	Image	Code	Description	Composants du kit																																																																																
VL1064A	DISTRIBUTEUR SORTIES SYSTEME LAVAGE PLUS		KVL1183A	KIT SYSTEME LAVAGE PLUS 1 BRAS	<table border="1"> <thead> <tr> <th>Code</th> <th>Description</th> <th>Qté</th> <th>UOM</th> </tr> </thead> <tbody> <tr> <td>RC1019A0</td> <td>COLLIER ELASTIQUE D10 ZINGUE</td> <td>12.000</td> <td>PCS</td> </tr> <tr> <td>RC1130A0</td> <td>COLLIER 130X2.6</td> <td>1.000</td> <td>PCS</td> </tr> <tr> <td>RC1131A0</td> <td>COLLIER 200X2.6 NOIR</td> <td>2.000</td> <td>PCS</td> </tr> <tr> <td>RC1242A0</td> <td>EXTREMITE FERME</td> <td>2.000</td> <td>PCS</td> </tr> <tr> <td>RC1356A0</td> <td>RACCORD DROIT FIL FEMELLE 8X1/4 BSP</td> <td>1.000</td> <td>PCS</td> </tr> <tr> <td>RC1414A1</td> <td>COLLIER A COMPRESSIO N D11.5-12.5</td> <td>1.000</td> <td>PCS</td> </tr> <tr> <td>TB2821A0</td> <td>TB2820A-L=40 MM EPDM NOI</td> <td>4.000</td> <td>PCS</td> </tr> <tr> <td>TB3004A0</td> <td>TB2820A L=550mm EPDM BLACK PIPE</td> <td>1.000</td> <td>PCS</td> </tr> <tr> <td>TB3005B0</td> <td>TB3132A L=550mm EPDM WHITE-BLUE PIPE</td> <td>1.000</td> <td>PCS</td> </tr> <tr> <td>TB3225B0</td> <td>TB2820A-L=67 0MM EPDM NOIR</td> <td>1.000</td> <td>PCS</td> </tr> <tr> <td>TB3252A0</td> <td>TB3252A0</td> <td>1.000</td> <td>PCS</td> </tr> <tr> <td>TB3614A0</td> <td></td> <td>1.000</td> <td>PCS</td> </tr> <tr> <td>VI1220A1</td> <td>VIS AUTOTARADE UX 4.2x12 TCB MARUTEX PRE</td> <td>1.000</td> <td>PCS</td> </tr> <tr> <td>VL1019A0</td> <td>POMPE DETERGENT VIBRATION</td> <td>1.000</td> <td>PCS</td> </tr> <tr> <td>VL1047A1</td> <td>PORTEGOMM E D6-EXTREMIT E D8</td> <td>1.000</td> <td>PCS</td> </tr> <tr> <td>VL1065A1</td> <td>PRESSOSTAT N.O. 1/4 M CIL</td> <td>1.000</td> <td>PCS</td> </tr> <tr> <td>VL1102A1</td> <td>FILTRE DANS LA LIGNE DET+VNR BARBED 6MM</td> <td>1.000</td> <td>PCS</td> </tr> <tr> <td>VL1128A1</td> <td>CLAPET ANTIRETOUR BARBED D6</td> <td>1.000</td> <td>PCS</td> </tr> <tr> <td>VL1166A0</td> <td>RACCORD EN L BB6-AL6</td> <td>3.000</td> <td>PCS</td> </tr> </tbody> </table>	Code	Description	Qté	UOM	RC1019A0	COLLIER ELASTIQUE D10 ZINGUE	12.000	PCS	RC1130A0	COLLIER 130X2.6	1.000	PCS	RC1131A0	COLLIER 200X2.6 NOIR	2.000	PCS	RC1242A0	EXTREMITE FERME	2.000	PCS	RC1356A0	RACCORD DROIT FIL FEMELLE 8X1/4 BSP	1.000	PCS	RC1414A1	COLLIER A COMPRESSIO N D11.5-12.5	1.000	PCS	TB2821A0	TB2820A-L=40 MM EPDM NOI	4.000	PCS	TB3004A0	TB2820A L=550mm EPDM BLACK PIPE	1.000	PCS	TB3005B0	TB3132A L=550mm EPDM WHITE-BLUE PIPE	1.000	PCS	TB3225B0	TB2820A-L=67 0MM EPDM NOIR	1.000	PCS	TB3252A0	TB3252A0	1.000	PCS	TB3614A0		1.000	PCS	VI1220A1	VIS AUTOTARADE UX 4.2x12 TCB MARUTEX PRE	1.000	PCS	VL1019A0	POMPE DETERGENT VIBRATION	1.000	PCS	VL1047A1	PORTEGOMM E D6-EXTREMIT E D8	1.000	PCS	VL1065A1	PRESSOSTAT N.O. 1/4 M CIL	1.000	PCS	VL1102A1	FILTRE DANS LA LIGNE DET+VNR BARBED 6MM	1.000	PCS	VL1128A1	CLAPET ANTIRETOUR BARBED D6	1.000	PCS	VL1166A0	RACCORD EN L BB6-AL6	3.000	PCS
Code	Description	Qté	UOM																																																																																		
RC1019A0	COLLIER ELASTIQUE D10 ZINGUE	12.000	PCS																																																																																		
RC1130A0	COLLIER 130X2.6	1.000	PCS																																																																																		
RC1131A0	COLLIER 200X2.6 NOIR	2.000	PCS																																																																																		
RC1242A0	EXTREMITE FERME	2.000	PCS																																																																																		
RC1356A0	RACCORD DROIT FIL FEMELLE 8X1/4 BSP	1.000	PCS																																																																																		
RC1414A1	COLLIER A COMPRESSIO N D11.5-12.5	1.000	PCS																																																																																		
TB2821A0	TB2820A-L=40 MM EPDM NOI	4.000	PCS																																																																																		
TB3004A0	TB2820A L=550mm EPDM BLACK PIPE	1.000	PCS																																																																																		
TB3005B0	TB3132A L=550mm EPDM WHITE-BLUE PIPE	1.000	PCS																																																																																		
TB3225B0	TB2820A-L=67 0MM EPDM NOIR	1.000	PCS																																																																																		
TB3252A0	TB3252A0	1.000	PCS																																																																																		
TB3614A0		1.000	PCS																																																																																		
VI1220A1	VIS AUTOTARADE UX 4.2x12 TCB MARUTEX PRE	1.000	PCS																																																																																		
VL1019A0	POMPE DETERGENT VIBRATION	1.000	PCS																																																																																		
VL1047A1	PORTEGOMM E D6-EXTREMIT E D8	1.000	PCS																																																																																		
VL1065A1	PRESSOSTAT N.O. 1/4 M CIL	1.000	PCS																																																																																		
VL1102A1	FILTRE DANS LA LIGNE DET+VNR BARBED 6MM	1.000	PCS																																																																																		
VL1128A1	CLAPET ANTIRETOUR BARBED D6	1.000	PCS																																																																																		
VL1166A0	RACCORD EN L BB6-AL6	3.000	PCS																																																																																		

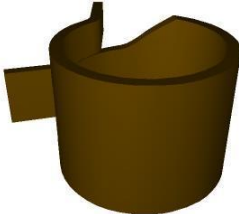
COMPOSANT			PIÈCE DE RECHANGE																																						
Code	Description	Image	Code	Description	Composants du kit																																				
VL1064A	DISTRIBUTEUR SORTIES SYSTEME LAVAGE PLUS		KVL1183A	KIT SYSTEME LAVAGE PLUS 1 BRAS	<table border="1"> <thead> <tr> <th>Code</th> <th>Description</th> <th>Qté</th> <th>UOM</th> </tr> </thead> <tbody> <tr> <td>VL1174C0</td> <td>INJECTEUR ETALLONE D 1.2 MM</td> <td>1.000</td> <td>PCS</td> </tr> <tr> <td>VL1185A0</td> <td>DISTRIBUTEUR R LAVAGE PLUS 2 VOIES PLUS</td> <td>1.000</td> <td>PCS</td> </tr> <tr> <td>VL1190A0</td> <td>DISTRIBUTEUR R ENTREE LAVAGE PLUS</td> <td>1.000</td> <td>PCS</td> </tr> <tr> <td>VL1214A0</td> <td>CLAPET ANTI RETOUR BB6 BAIONETTE</td> <td>1.000</td> <td>PCS</td> </tr> <tr> <td>VM1605A0</td> <td>CLIP TWIST LOCK DIAM. 10,2-12,7 MM</td> <td>3.000</td> <td>PCS</td> </tr> <tr> <td>VM2172A0</td> <td>CLIP BLOCAGE POMPE AVEC CIRCUIT</td> <td>4.000</td> <td>PCS</td> </tr> </tbody> </table>	Code	Description	Qté	UOM	VL1174C0	INJECTEUR ETALLONE D 1.2 MM	1.000	PCS	VL1185A0	DISTRIBUTEUR R LAVAGE PLUS 2 VOIES PLUS	1.000	PCS	VL1190A0	DISTRIBUTEUR R ENTREE LAVAGE PLUS	1.000	PCS	VL1214A0	CLAPET ANTI RETOUR BB6 BAIONETTE	1.000	PCS	VM1605A0	CLIP TWIST LOCK DIAM. 10,2-12,7 MM	3.000	PCS	VM2172A0	CLIP BLOCAGE POMPE AVEC CIRCUIT	4.000	PCS								
Code	Description	Qté	UOM																																						
VL1174C0	INJECTEUR ETALLONE D 1.2 MM	1.000	PCS																																						
VL1185A0	DISTRIBUTEUR R LAVAGE PLUS 2 VOIES PLUS	1.000	PCS																																						
VL1190A0	DISTRIBUTEUR R ENTREE LAVAGE PLUS	1.000	PCS																																						
VL1214A0	CLAPET ANTI RETOUR BB6 BAIONETTE	1.000	PCS																																						
VM1605A0	CLIP TWIST LOCK DIAM. 10,2-12,7 MM	3.000	PCS																																						
VM2172A0	CLIP BLOCAGE POMPE AVEC CIRCUIT	4.000	PCS																																						
VL1065A	PRESSOSTAT N.O. 1/4 M CIL		KVL1065A	KIT PRESOSTAT N.O.1/4 M CIL	<table border="1"> <thead> <tr> <th>Code</th> <th>Description</th> <th>Qté</th> <th>UOM</th> </tr> </thead> <tbody> <tr> <td>VL1065A1</td> <td>PRESSOSTAT N.O. 1/4 M CIL</td> <td>1.000</td> <td>PCS</td> </tr> </tbody> </table>	Code	Description	Qté	UOM	VL1065A1	PRESSOSTAT N.O. 1/4 M CIL	1.000	PCS																												
Code	Description	Qté	UOM																																						
VL1065A1	PRESSOSTAT N.O. 1/4 M CIL	1.000	PCS																																						
VL1067A	DISTRIBUTEUR ENTREES SYST LAVAGE		KVL1183A	KIT SYSTEME LAVAGE PLUS 1 BRAS	<table border="1"> <thead> <tr> <th>Code</th> <th>Description</th> <th>Qté</th> <th>UOM</th> </tr> </thead> <tbody> <tr> <td>0H2354A1</td> <td>TOLE SYSTEME LAVAGE PLUS XEVC-XEVL</td> <td>1.000</td> <td>PCS</td> </tr> <tr> <td>EL1440A0</td> <td>ELECTROVAN NE H2O AUTONETTOY ANTE BAIONNET</td> <td>3.000</td> <td>PCS</td> </tr> <tr> <td>GN1526A0</td> <td>O-RING D.INT6,9 SP1,8</td> <td>7.000</td> <td>PCS</td> </tr> <tr> <td>RC1018A0</td> <td>COLLIER ELASTIQUE D12 ZINGUE</td> <td>1.000</td> <td>PCS</td> </tr> <tr> <td>RC1019A0</td> <td>COLLIER ELASTIQUE D10 ZINGUE</td> <td>12.000</td> <td>PCS</td> </tr> <tr> <td>RC1130A0</td> <td>COLLIER 130X2,6</td> <td>1.000</td> <td>PCS</td> </tr> <tr> <td>RC1131A0</td> <td>COLLIER 200X2,6 NOIR</td> <td>2.000</td> <td>PCS</td> </tr> <tr> <td>RC1242A0</td> <td>EXTREMITE FERME</td> <td>2.000</td> <td>PCS</td> </tr> </tbody> </table>	Code	Description	Qté	UOM	0H2354A1	TOLE SYSTEME LAVAGE PLUS XEVC-XEVL	1.000	PCS	EL1440A0	ELECTROVAN NE H2O AUTONETTOY ANTE BAIONNET	3.000	PCS	GN1526A0	O-RING D.INT6,9 SP1,8	7.000	PCS	RC1018A0	COLLIER ELASTIQUE D12 ZINGUE	1.000	PCS	RC1019A0	COLLIER ELASTIQUE D10 ZINGUE	12.000	PCS	RC1130A0	COLLIER 130X2,6	1.000	PCS	RC1131A0	COLLIER 200X2,6 NOIR	2.000	PCS	RC1242A0	EXTREMITE FERME	2.000	PCS
Code	Description	Qté	UOM																																						
0H2354A1	TOLE SYSTEME LAVAGE PLUS XEVC-XEVL	1.000	PCS																																						
EL1440A0	ELECTROVAN NE H2O AUTONETTOY ANTE BAIONNET	3.000	PCS																																						
GN1526A0	O-RING D.INT6,9 SP1,8	7.000	PCS																																						
RC1018A0	COLLIER ELASTIQUE D12 ZINGUE	1.000	PCS																																						
RC1019A0	COLLIER ELASTIQUE D10 ZINGUE	12.000	PCS																																						
RC1130A0	COLLIER 130X2,6	1.000	PCS																																						
RC1131A0	COLLIER 200X2,6 NOIR	2.000	PCS																																						
RC1242A0	EXTREMITE FERME	2.000	PCS																																						

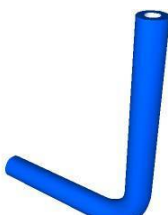
COMPOSANT			PIÈCE DE RECHANGE																																																																														
Code	Description	Image	Code	Description	Composants du kit																																																																												
VL1067A	DISTRIBUTEUR ENTREES SYST LAVAGE		KVL1183A	KIT SYSTEME LAVAGE PLUS 1 BRAS	<table border="1"> <thead> <tr> <th>Code</th> <th>Description</th> <th>Qté</th> <th>UOM</th> </tr> </thead> <tbody> <tr> <td>RC1356A0</td> <td>RACCORD DROIT FIL FEMELLE 8X1/4 BSP</td> <td>1.000</td> <td>PCS</td> </tr> <tr> <td>RC1414A1</td> <td>COLLIER A COMPRESSIO N D11.5-12.5</td> <td>1.000</td> <td>PCS</td> </tr> <tr> <td>TB2821A0</td> <td>TB2820A-L=40 MM EPDM NOI</td> <td>4.000</td> <td>PCS</td> </tr> <tr> <td>TB3004A0</td> <td>TB2820A L=550mm EPDM BLACK PIPE</td> <td>1.000</td> <td>PCS</td> </tr> <tr> <td>TB3005B0</td> <td>TB3132A L=550mm EPDM WHITE-BLUE PIPE</td> <td>1.000</td> <td>PCS</td> </tr> <tr> <td>TB3225B0</td> <td>TB2820A-L=67 0MM EPDM NOIR</td> <td>1.000</td> <td>PCS</td> </tr> <tr> <td>TB3252A0</td> <td>TB3252A0</td> <td>1.000</td> <td>PCS</td> </tr> <tr> <td>TB3614A0</td> <td></td> <td>1.000</td> <td>PCS</td> </tr> <tr> <td>VI1220A1</td> <td>VIS AUTOTARADE UX 4.2x12 TCB MARUTEX PRE</td> <td>1.000</td> <td>PCS</td> </tr> <tr> <td>VL1019A0</td> <td>POMPE DETERGENT VIBRATION</td> <td>1.000</td> <td>PCS</td> </tr> <tr> <td>VL1047A1</td> <td>PORTEGOMM E D6-EXTREMIT E D8</td> <td>1.000</td> <td>PCS</td> </tr> <tr> <td>VL1065A1</td> <td>PRESSOSTAT N.O. 1/4 M CIL</td> <td>1.000</td> <td>PCS</td> </tr> <tr> <td>VL1102A1</td> <td>FILTRE DANS LA LIGNE DET+VNR BARBED 6MM</td> <td>1.000</td> <td>PCS</td> </tr> <tr> <td>VL1128A1</td> <td>CLAPET ANTIRETOUR BARBED D6</td> <td>1.000</td> <td>PCS</td> </tr> <tr> <td>VL1166A0</td> <td>RACCORD EN L BB6-AL6</td> <td>3.000</td> <td>PCS</td> </tr> <tr> <td>VL1174C0</td> <td>INJECTEUR ETALLONE D 1.2 MM</td> <td>1.000</td> <td>PCS</td> </tr> <tr> <td>VL1185A0</td> <td>DISTRIBUTEU R LAVAGE PLUS 2 VOIES PLUS</td> <td>1.000</td> <td>PCS</td> </tr> <tr> <td>VL1190A0</td> <td>DISTRIBUTEU R ENTREE LAVAGE PLUS</td> <td>1.000</td> <td>PCS</td> </tr> </tbody> </table>	Code	Description	Qté	UOM	RC1356A0	RACCORD DROIT FIL FEMELLE 8X1/4 BSP	1.000	PCS	RC1414A1	COLLIER A COMPRESSIO N D11.5-12.5	1.000	PCS	TB2821A0	TB2820A-L=40 MM EPDM NOI	4.000	PCS	TB3004A0	TB2820A L=550mm EPDM BLACK PIPE	1.000	PCS	TB3005B0	TB3132A L=550mm EPDM WHITE-BLUE PIPE	1.000	PCS	TB3225B0	TB2820A-L=67 0MM EPDM NOIR	1.000	PCS	TB3252A0	TB3252A0	1.000	PCS	TB3614A0		1.000	PCS	VI1220A1	VIS AUTOTARADE UX 4.2x12 TCB MARUTEX PRE	1.000	PCS	VL1019A0	POMPE DETERGENT VIBRATION	1.000	PCS	VL1047A1	PORTEGOMM E D6-EXTREMIT E D8	1.000	PCS	VL1065A1	PRESSOSTAT N.O. 1/4 M CIL	1.000	PCS	VL1102A1	FILTRE DANS LA LIGNE DET+VNR BARBED 6MM	1.000	PCS	VL1128A1	CLAPET ANTIRETOUR BARBED D6	1.000	PCS	VL1166A0	RACCORD EN L BB6-AL6	3.000	PCS	VL1174C0	INJECTEUR ETALLONE D 1.2 MM	1.000	PCS	VL1185A0	DISTRIBUTEU R LAVAGE PLUS 2 VOIES PLUS	1.000	PCS	VL1190A0	DISTRIBUTEU R ENTREE LAVAGE PLUS	1.000	PCS
Code	Description	Qté	UOM																																																																														
RC1356A0	RACCORD DROIT FIL FEMELLE 8X1/4 BSP	1.000	PCS																																																																														
RC1414A1	COLLIER A COMPRESSIO N D11.5-12.5	1.000	PCS																																																																														
TB2821A0	TB2820A-L=40 MM EPDM NOI	4.000	PCS																																																																														
TB3004A0	TB2820A L=550mm EPDM BLACK PIPE	1.000	PCS																																																																														
TB3005B0	TB3132A L=550mm EPDM WHITE-BLUE PIPE	1.000	PCS																																																																														
TB3225B0	TB2820A-L=67 0MM EPDM NOIR	1.000	PCS																																																																														
TB3252A0	TB3252A0	1.000	PCS																																																																														
TB3614A0		1.000	PCS																																																																														
VI1220A1	VIS AUTOTARADE UX 4.2x12 TCB MARUTEX PRE	1.000	PCS																																																																														
VL1019A0	POMPE DETERGENT VIBRATION	1.000	PCS																																																																														
VL1047A1	PORTEGOMM E D6-EXTREMIT E D8	1.000	PCS																																																																														
VL1065A1	PRESSOSTAT N.O. 1/4 M CIL	1.000	PCS																																																																														
VL1102A1	FILTRE DANS LA LIGNE DET+VNR BARBED 6MM	1.000	PCS																																																																														
VL1128A1	CLAPET ANTIRETOUR BARBED D6	1.000	PCS																																																																														
VL1166A0	RACCORD EN L BB6-AL6	3.000	PCS																																																																														
VL1174C0	INJECTEUR ETALLONE D 1.2 MM	1.000	PCS																																																																														
VL1185A0	DISTRIBUTEU R LAVAGE PLUS 2 VOIES PLUS	1.000	PCS																																																																														
VL1190A0	DISTRIBUTEU R ENTREE LAVAGE PLUS	1.000	PCS																																																																														

COMPOSANT			PIÈCE DE RECHANGE																		
Code	Description	Image	Code	Description	Composants du kit																
VL1067A	DISTRIBUTEUR ENTREES SYST LAVAGE		KVL1183A	KIT SYSTEME LAVAGE PLUS 1 BRAS	<table border="1"> <thead> <tr> <th>Code</th> <th>Description</th> <th>Qté</th> <th>UOM</th> </tr> </thead> <tbody> <tr> <td>VL1214A0</td> <td>CLAPET ANTI RETOUR BB6 BAIONETTE</td> <td>1.000</td> <td>PCS</td> </tr> <tr> <td>VM1605A0</td> <td>CLIP TWIST LOCK DIAM. 10,2-12,7 MM</td> <td>3.000</td> <td>PCS</td> </tr> <tr> <td>VM2172A0</td> <td>CLIP BLOCAGE POMPE AVEC CIRCUIT</td> <td>4.000</td> <td>PCS</td> </tr> </tbody> </table>	Code	Description	Qté	UOM	VL1214A0	CLAPET ANTI RETOUR BB6 BAIONETTE	1.000	PCS	VM1605A0	CLIP TWIST LOCK DIAM. 10,2-12,7 MM	3.000	PCS	VM2172A0	CLIP BLOCAGE POMPE AVEC CIRCUIT	4.000	PCS
Code	Description	Qté	UOM																		
VL1214A0	CLAPET ANTI RETOUR BB6 BAIONETTE	1.000	PCS																		
VM1605A0	CLIP TWIST LOCK DIAM. 10,2-12,7 MM	3.000	PCS																		
VM2172A0	CLIP BLOCAGE POMPE AVEC CIRCUIT	4.000	PCS																		
VL1128A	D6 BARBED CHECK VALVE		KVL1128A	KIT VANNE VNR BARBED D6	<table border="1"> <thead> <tr> <th>Code</th> <th>Description</th> <th>Qté</th> <th>UOM</th> </tr> </thead> <tbody> <tr> <td>RC1019A0</td> <td>COLLIER ELASTIQUE D10 ZINGUE</td> <td>4.000</td> <td>PCS</td> </tr> <tr> <td>TB2820A0</td> <td>TUYAU EPDM 6X10</td> <td>0.080</td> <td>M</td> </tr> <tr> <td>VL1128A1</td> <td>CLAPET ANTIRETOUR BARBED D6</td> <td>1.000</td> <td>PCS</td> </tr> </tbody> </table>	Code	Description	Qté	UOM	RC1019A0	COLLIER ELASTIQUE D10 ZINGUE	4.000	PCS	TB2820A0	TUYAU EPDM 6X10	0.080	M	VL1128A1	CLAPET ANTIRETOUR BARBED D6	1.000	PCS
Code	Description	Qté	UOM																		
RC1019A0	COLLIER ELASTIQUE D10 ZINGUE	4.000	PCS																		
TB2820A0	TUYAU EPDM 6X10	0.080	M																		
VL1128A1	CLAPET ANTIRETOUR BARBED D6	1.000	PCS																		
VM2172A	CLIP BLOCAGE POMPE AVEC CIRCUIT		VM2172A0	CLIP BLOCAGE POMPE AVEC CIRCUIT																	
EL1252A	ELECTROVANNE 1 VOIE + CONNEXION J.G.		KEL1252A	KIT ELECTROVANNE EL2 1 VOIE JG D8-D1	<table border="1"> <thead> <tr> <th>Code</th> <th>Description</th> <th>Qté</th> <th>UOM</th> </tr> </thead> <tbody> <tr> <td>EL1252A1</td> <td>ELECTROVAN NE 1 VOIE + CONNEXION J.G.</td> <td>1.000</td> <td>PCS</td> </tr> </tbody> </table>	Code	Description	Qté	UOM	EL1252A1	ELECTROVAN NE 1 VOIE + CONNEXION J.G.	1.000	PCS								
Code	Description	Qté	UOM																		
EL1252A1	ELECTROVAN NE 1 VOIE + CONNEXION J.G.	1.000	PCS																		
EL1424A	EL H2O JG D8-RACC CANNELE D6		KEL1424B	KIT ELECTROV. EG1 JG D8-PORTEGOMME D	<table border="1"> <thead> <tr> <th>Code</th> <th>Description</th> <th>Qté</th> <th>UOM</th> </tr> </thead> <tbody> <tr> <td>EL1424B0</td> <td>EL H2O JG D8-RACC CANNELE D6</td> <td>1.000</td> <td>PCS</td> </tr> <tr> <td>V11095B0</td> <td>VIS AUTOTARAUD EUUSE 3.9X9.5 + INOX</td> <td>2.000</td> <td>PCS</td> </tr> </tbody> </table>	Code	Description	Qté	UOM	EL1424B0	EL H2O JG D8-RACC CANNELE D6	1.000	PCS	V11095B0	VIS AUTOTARAUD EUUSE 3.9X9.5 + INOX	2.000	PCS				
Code	Description	Qté	UOM																		
EL1424B0	EL H2O JG D8-RACC CANNELE D6	1.000	PCS																		
V11095B0	VIS AUTOTARAUD EUUSE 3.9X9.5 + INOX	2.000	PCS																		

COMPOSANT			PIÈCE DE RECHANGE										
Code	Description	Image	Code	Description	Composants du kit								
EL1436A	EV H2O JG D8-RACCORD CANNELE D6 CHECK VA		KEL1436B	KIT ELECTROV.H2O JG D8-PORTEGOMME D6 VNR	<table border="1"> <thead> <tr> <th>Code</th> <th>Description</th> <th>Qté</th> <th>UOM</th> </tr> </thead> <tbody> <tr> <td>EL1436B0</td> <td>ELECTROVAN NE H2O JG D8-BARBED D6 VNR</td> <td>1.000</td> <td>PCS</td> </tr> </tbody> </table>	Code	Description	Qté	UOM	EL1436B0	ELECTROVAN NE H2O JG D8-BARBED D6 VNR	1.000	PCS
Code	Description	Qté	UOM										
EL1436B0	ELECTROVAN NE H2O JG D8-BARBED D6 VNR	1.000	PCS										
RC1019A	COLLIER ELASTIQUE D10 ZINGUE		KRC1019A	KIT COLLIER ELASTIQUE D10 ZINGUEE 15 PCS	<table border="1"> <thead> <tr> <th>Code</th> <th>Description</th> <th>Qté</th> <th>UOM</th> </tr> </thead> <tbody> <tr> <td>RC1019A0</td> <td>COLLIER ELASTIQUE D10 ZINGUE</td> <td>15.000</td> <td>PCS</td> </tr> </tbody> </table>	Code	Description	Qté	UOM	RC1019A0	COLLIER ELASTIQUE D10 ZINGUE	15.000	PCS
Code	Description	Qté	UOM										
RC1019A0	COLLIER ELASTIQUE D10 ZINGUE	15.000	PCS										
TB3004A	TB2820A L=550mm EPDM BLACK PIPE		KTB1343A	KIT TUYAU EPDM 6X10 TB2820A0 L=3	<table border="1"> <thead> <tr> <th>Code</th> <th>Description</th> <th>Qté</th> <th>UOM</th> </tr> </thead> <tbody> <tr> <td>TB2820A0</td> <td>TUYAU EPDM 6X10</td> <td>3.000</td> <td>M</td> </tr> </tbody> </table>	Code	Description	Qté	UOM	TB2820A0	TUYAU EPDM 6X10	3.000	M
Code	Description	Qté	UOM										
TB2820A0	TUYAU EPDM 6X10	3.000	M										
TB3005B	TB3132A L=550mm EPDM WHITE-BLUE PIPE		KTB3132A	KIT TUYAU REINF EPDM BLANC-BLEU 6X12 3M	<table border="1"> <thead> <tr> <th>Code</th> <th>Description</th> <th>Qté</th> <th>UOM</th> </tr> </thead> <tbody> <tr> <td>TB3132A0</td> <td>TUYAU ENTOILE EPDM BLANC-BLEU 6X12</td> <td>3.000</td> <td>M</td> </tr> </tbody> </table>	Code	Description	Qté	UOM	TB3132A0	TUYAU ENTOILE EPDM BLANC-BLEU 6X12	3.000	M
Code	Description	Qté	UOM										
TB3132A0	TUYAU ENTOILE EPDM BLANC-BLEU 6X12	3.000	M										
TB3026C	TB3132A-WASHING PLUS INLET PIPE L=200		KVL0012A	KIT TUYAU REINF BLANC-BLEU 6X12 100M	<table border="1"> <thead> <tr> <th>Code</th> <th>Description</th> <th>Qté</th> <th>UOM</th> </tr> </thead> <tbody> <tr> <td>TB3132A0</td> <td>TUYAU ENTOILE EPDM BLANC-BLEU 6X12</td> <td>100.000</td> <td>M</td> </tr> </tbody> </table>	Code	Description	Qté	UOM	TB3132A0	TUYAU ENTOILE EPDM BLANC-BLEU 6X12	100.000	M
Code	Description	Qté	UOM										
TB3132A0	TUYAU ENTOILE EPDM BLANC-BLEU 6X12	100.000	M										
			KTB3132A	KIT TUYAU REINF EPDM BLANC-BLEU 6X12 3M	<table border="1"> <thead> <tr> <th>Code</th> <th>Description</th> <th>Qté</th> <th>UOM</th> </tr> </thead> <tbody> <tr> <td>TB3132A0</td> <td>TUYAU ENTOILE EPDM BLANC-BLEU 6X12</td> <td>3.000</td> <td>M</td> </tr> </tbody> </table>	Code	Description	Qté	UOM	TB3132A0	TUYAU ENTOILE EPDM BLANC-BLEU 6X12	3.000	M
Code	Description	Qté	UOM										
TB3132A0	TUYAU ENTOILE EPDM BLANC-BLEU 6X12	3.000	M										

COMPOSANT			PIÈCE DE RECHANGE																		
Code	Description	Image	Code	Description	Composants du kit																
TB3225B	TB2820A-L=670MM EPDM NOIR		KTB1343A	KIT TUYAU EPDM 6X10 TB2820A0 L=3	<table border="1"> <thead> <tr> <th>Code</th> <th>Description</th> <th>Qté</th> <th>UOM</th> </tr> </thead> <tbody> <tr> <td>TB2820A0</td> <td>TUYAU EPDM 6X10</td> <td>3.000</td> <td>M</td> </tr> </tbody> </table>	Code	Description	Qté	UOM	TB2820A0	TUYAU EPDM 6X10	3.000	M								
Code	Description	Qté	UOM																		
TB2820A0	TUYAU EPDM 6X10	3.000	M																		
VL1047A	PORTEGOMME D6-EXTREMITE D8		KVL1047A	KIT 10 PCS PORTEGOMME D6 EXTREMITE D8	<table border="1"> <thead> <tr> <th>Code</th> <th>Description</th> <th>Qté</th> <th>UOM</th> </tr> </thead> <tbody> <tr> <td>VL1047A1</td> <td>PORTEGOMM E D6-EXTREMIT E D8</td> <td>10.000</td> <td>PCS</td> </tr> </tbody> </table>	Code	Description	Qté	UOM	VL1047A1	PORTEGOMM E D6-EXTREMIT E D8	10.000	PCS								
Code	Description	Qté	UOM																		
VL1047A1	PORTEGOMM E D6-EXTREMIT E D8	10.000	PCS																		
VL1095A	RACC DROIT M-M RACC CANNELE D7.8-D10		KVL1095A	KIT 10PCS RACCORD DROIT PORTEGOMM D7-D1	<table border="1"> <thead> <tr> <th>Code</th> <th>Description</th> <th>Qté</th> <th>UOM</th> </tr> </thead> <tbody> <tr> <td>VL1095A0</td> <td>RACC DROIT M-M RACC CANNELE D7.8-D10</td> <td>10.000</td> <td>PCS</td> </tr> </tbody> </table>	Code	Description	Qté	UOM	VL1095A0	RACC DROIT M-M RACC CANNELE D7.8-D10	10.000	PCS								
Code	Description	Qté	UOM																		
VL1095A0	RACC DROIT M-M RACC CANNELE D7.8-D10	10.000	PCS																		
VL1102A	FILTRE DANS LA LIGNE DET+VNR BARBED 6MM		KVL1102A	KIT FILTRE DETERGENT CLAPET ANTI-RETOUR	<table border="1"> <thead> <tr> <th>Code</th> <th>Description</th> <th>Qté</th> <th>UOM</th> </tr> </thead> <tbody> <tr> <td>RC1019A0</td> <td>COLLIER ELASTIQUE D10 ZINGUE</td> <td>5.000</td> <td>PCS</td> </tr> <tr> <td>TB2820A0</td> <td>TUYAU EPDM 6X10</td> <td>0.040</td> <td>M</td> </tr> <tr> <td>VL1102A1</td> <td>FILTRE DANS LA LIGNE DET+VNR BARBED 6MM</td> <td>1.000</td> <td>PCS</td> </tr> </tbody> </table>	Code	Description	Qté	UOM	RC1019A0	COLLIER ELASTIQUE D10 ZINGUE	5.000	PCS	TB2820A0	TUYAU EPDM 6X10	0.040	M	VL1102A1	FILTRE DANS LA LIGNE DET+VNR BARBED 6MM	1.000	PCS
Code	Description	Qté	UOM																		
RC1019A0	COLLIER ELASTIQUE D10 ZINGUE	5.000	PCS																		
TB2820A0	TUYAU EPDM 6X10	0.040	M																		
VL1102A1	FILTRE DANS LA LIGNE DET+VNR BARBED 6MM	1.000	PCS																		
GN1558A	EXHAUST SEAL		KVP1168A	KIT D'ANNEAU D'ÉTANCHÉITÉ POUR CHEMINÉE	<table border="1"> <thead> <tr> <th>Code</th> <th>Description</th> <th>Qté</th> <th>UOM</th> </tr> </thead> <tbody> <tr> <td>VI1220A1</td> <td>VIS AUTOTRADE UX 4.2x12 TCB MARUTEX PRE</td> <td>3.000</td> <td>PCS</td> </tr> <tr> <td>VP1168A0</td> <td>COLLET TENUE CHEMINEE</td> <td>1.000</td> <td>PCS</td> </tr> </tbody> </table>	Code	Description	Qté	UOM	VI1220A1	VIS AUTOTRADE UX 4.2x12 TCB MARUTEX PRE	3.000	PCS	VP1168A0	COLLET TENUE CHEMINEE	1.000	PCS				
Code	Description	Qté	UOM																		
VI1220A1	VIS AUTOTRADE UX 4.2x12 TCB MARUTEX PRE	3.000	PCS																		
VP1168A0	COLLET TENUE CHEMINEE	1.000	PCS																		

COMPOSANT			PIÈCE DE RECHANGE																										
Code	Description	Image	Code	Description	Composants du kit																								
TR1136A	THERMOSTAT DE SECURITE 318°C -0/+24		KTR1136A	KIT THERMOSTAT DE SECURITE 318°C -0/+24	<table border="1"> <thead> <tr> <th>Code</th> <th>Description</th> <th>Qté</th> <th>UOM</th> </tr> </thead> <tbody> <tr> <td>0H8120A0</td> <td>COUVERCLE ENTREE AMPOULE XEV</td> <td>1.000</td> <td>PCS</td> </tr> <tr> <td>GN1531A0</td> <td>JOINT D'ETANCHEITE ENTREE BULBE</td> <td>1.000</td> <td>PCS</td> </tr> <tr> <td>SL1045A0</td> <td>SILICONE ANTHRACITE S57 sp-5007 80ml</td> <td>1.000</td> <td>PCS</td> </tr> <tr> <td>TR1136A0</td> <td>THERMOSTAT DE SECURITE 318°C -0/+24</td> <td>1.000</td> <td>PCS</td> </tr> <tr> <td>VI1220A1</td> <td>VIS AUTOTARADE UX 4.2x12 TCB MARUTEX PRE</td> <td>3.000</td> <td>PCS</td> </tr> </tbody> </table>	Code	Description	Qté	UOM	0H8120A0	COUVERCLE ENTREE AMPOULE XEV	1.000	PCS	GN1531A0	JOINT D'ETANCHEITE ENTREE BULBE	1.000	PCS	SL1045A0	SILICONE ANTHRACITE S57 sp-5007 80ml	1.000	PCS	TR1136A0	THERMOSTAT DE SECURITE 318°C -0/+24	1.000	PCS	VI1220A1	VIS AUTOTARADE UX 4.2x12 TCB MARUTEX PRE	3.000	PCS
Code	Description	Qté	UOM																										
0H8120A0	COUVERCLE ENTREE AMPOULE XEV	1.000	PCS																										
GN1531A0	JOINT D'ETANCHEITE ENTREE BULBE	1.000	PCS																										
SL1045A0	SILICONE ANTHRACITE S57 sp-5007 80ml	1.000	PCS																										
TR1136A0	THERMOSTAT DE SECURITE 318°C -0/+24	1.000	PCS																										
VI1220A1	VIS AUTOTARADE UX 4.2x12 TCB MARUTEX PRE	3.000	PCS																										
VM1750A	BRASS COMB CLAM		KVM1750A	KIT BORNIER	<table border="1"> <thead> <tr> <th>Code</th> <th>Description</th> <th>Qté</th> <th>UOM</th> </tr> </thead> <tbody> <tr> <td>VI1040A0</td> <td>FR-ROSETTA DENTELLATA INTERNA ø6 Z</td> <td>2.000</td> <td>PCS</td> </tr> <tr> <td>VM1750A0</td> <td>BRASS COMB CLAMP</td> <td>1.000</td> <td>PCS</td> </tr> </tbody> </table>	Code	Description	Qté	UOM	VI1040A0	FR-ROSETTA DENTELLATA INTERNA ø6 Z	2.000	PCS	VM1750A0	BRASS COMB CLAMP	1.000	PCS												
Code	Description	Qté	UOM																										
VI1040A0	FR-ROSETTA DENTELLATA INTERNA ø6 Z	2.000	PCS																										
VM1750A0	BRASS COMB CLAMP	1.000	PCS																										
VM1810A	BOUCHON TENUE EAU DROIT		VM1810A0	BOUCHON TENUE EAU DROIT																									
VM1811A	BOUCHON TENUE EAU GAUCHE		VM1811A0	BOUCHON TENUE EAU GAUCHE																									

COMPOSANT			PIÈCE DE RECHANGE																						
Code	Description	Image	Code	Description	Composants du kit																				
VM1991A	BAC DE RECUPERATION 750		KVM1991A	KIT EGOUTTOIR	<table border="1"> <thead> <tr> <th>Code</th> <th>Description</th> <th>Qté</th> <th>UOM</th> </tr> </thead> <tbody> <tr> <td>VM1220A0</td> <td>CLIP FIXATION EGOUTTOIR C.T.</td> <td>4.000</td> <td>PCS</td> </tr> <tr> <td>VM1991A0</td> <td>BAC DE RECUPERATION 750</td> <td>1.000</td> <td>PCS</td> </tr> <tr> <td>VM2074A1</td> <td>CLIP AVEC VIS SUPPORT DE TIRROIR</td> <td>4.000</td> <td>PCS</td> </tr> </tbody> </table>	Code	Description	Qté	UOM	VM1220A0	CLIP FIXATION EGOUTTOIR C.T.	4.000	PCS	VM1991A0	BAC DE RECUPERATION 750	1.000	PCS	VM2074A1	CLIP AVEC VIS SUPPORT DE TIRROIR	4.000	PCS				
Code	Description	Qté	UOM																						
VM1220A0	CLIP FIXATION EGOUTTOIR C.T.	4.000	PCS																						
VM1991A0	BAC DE RECUPERATION 750	1.000	PCS																						
VM2074A1	CLIP AVEC VIS SUPPORT DE TIRROIR	4.000	PCS																						
VM2035A	SUPPORT POUR TUYAU DECHARGE		KVM2035A	KIT 2 PIECES SUPPORT TUYAU DECHARGE	<table border="1"> <thead> <tr> <th>Code</th> <th>Description</th> <th>Qté</th> <th>UOM</th> </tr> </thead> <tbody> <tr> <td>VM2035A0</td> <td>SUPPORT POUR TUYAU DECHARGE</td> <td>2.000</td> <td>PCS</td> </tr> </tbody> </table>	Code	Description	Qté	UOM	VM2035A0	SUPPORT POUR TUYAU DECHARGE	2.000	PCS												
Code	Description	Qté	UOM																						
VM2035A0	SUPPORT POUR TUYAU DECHARGE	2.000	PCS																						
VM2061A	ACCESSORIES CABLES WALL PASSING		KVM1505A	KIT PASSE-PAROI AVEC DIAPHRAGME	<table border="1"> <thead> <tr> <th>Code</th> <th>Description</th> <th>Qté</th> <th>UOM</th> </tr> </thead> <tbody> <tr> <td>VI1220A1</td> <td>VIS AUTOTARADE UX 4.2x12 TCB MARUTEX PRE</td> <td>1.000</td> <td>PCS</td> </tr> <tr> <td>VM1505A0</td> <td>PASSE-PAROI AVEC DIAPHRAGME</td> <td>3.000</td> <td>PCS</td> </tr> <tr> <td>VM2055A0</td> <td>PASSE-PAROI CABLES ACCESSOIRES SUP</td> <td>1.000</td> <td>PCS</td> </tr> <tr> <td>VM2056A0</td> <td>PASSE-PAROI CABLES ACCESSOIRES INF</td> <td>1.000</td> <td>PCS</td> </tr> </tbody> </table>	Code	Description	Qté	UOM	VI1220A1	VIS AUTOTARADE UX 4.2x12 TCB MARUTEX PRE	1.000	PCS	VM1505A0	PASSE-PAROI AVEC DIAPHRAGME	3.000	PCS	VM2055A0	PASSE-PAROI CABLES ACCESSOIRES SUP	1.000	PCS	VM2056A0	PASSE-PAROI CABLES ACCESSOIRES INF	1.000	PCS
Code	Description	Qté	UOM																						
VI1220A1	VIS AUTOTARADE UX 4.2x12 TCB MARUTEX PRE	1.000	PCS																						
VM1505A0	PASSE-PAROI AVEC DIAPHRAGME	3.000	PCS																						
VM2055A0	PASSE-PAROI CABLES ACCESSOIRES SUP	1.000	PCS																						
VM2056A0	PASSE-PAROI CABLES ACCESSOIRES INF	1.000	PCS																						
VM2074A	DRIP TRAY FIXING CLIP WITH SCREW		KVM1220A	KIT 4 PCS CLIP SUPPORT EGOUTTOIR CT BT	<table border="1"> <thead> <tr> <th>Code</th> <th>Description</th> <th>Qté</th> <th>UOM</th> </tr> </thead> <tbody> <tr> <td>VI1220A1</td> <td>VIS AUTOTARADE UX 4.2x12 TCB MARUTEX PRE</td> <td>4.000</td> <td>PCS</td> </tr> <tr> <td>VM1220A0</td> <td>CLIP FIXATION EGOUTTOIR C.T.</td> <td>4.000</td> <td>PCS</td> </tr> <tr> <td>VM2074A1</td> <td>CLIP AVEC VIS SUPPORT DE TIRROIR</td> <td>4.000</td> <td>PCS</td> </tr> </tbody> </table>	Code	Description	Qté	UOM	VI1220A1	VIS AUTOTARADE UX 4.2x12 TCB MARUTEX PRE	4.000	PCS	VM1220A0	CLIP FIXATION EGOUTTOIR C.T.	4.000	PCS	VM2074A1	CLIP AVEC VIS SUPPORT DE TIRROIR	4.000	PCS				
Code	Description	Qté	UOM																						
VI1220A1	VIS AUTOTARADE UX 4.2x12 TCB MARUTEX PRE	4.000	PCS																						
VM1220A0	CLIP FIXATION EGOUTTOIR C.T.	4.000	PCS																						
VM2074A1	CLIP AVEC VIS SUPPORT DE TIRROIR	4.000	PCS																						



COMPOSANT			PIÈCE DE RECHANGE										
Code	Description	Image	Code	Description	Composants du kit								
VM2249A	COOKING CHAMBER FRONT CORNER		KVM2249A	KIT ANGLE FAÇADE MOUFLE	<table border="1"> <thead> <tr> <th>Code</th> <th>Description</th> <th>Qté</th> <th>UOM</th> </tr> </thead> <tbody> <tr> <td>VM2249A0</td> <td>COOKING CHAMBER FRONT CORNER</td> <td>1.000</td> <td>PCS</td> </tr> </tbody> </table>	Code	Description	Qté	UOM	VM2249A0	COOKING CHAMBER FRONT CORNER	1.000	PCS
Code	Description	Qté	UOM										
VM2249A0	COOKING CHAMBER FRONT CORNER	1.000	PCS										
VM2311A	PLAQUETTE COUVRE VIS		KVM2311A	KIT PLAQUETTE COUVRE VIS VM2311A0	<table border="1"> <thead> <tr> <th>Code</th> <th>Description</th> <th>Qté</th> <th>UOM</th> </tr> </thead> <tbody> <tr> <td>VM2311A0</td> <td>PLAQUETTE COUVRE VIS</td> <td>1.000</td> <td>PCS</td> </tr> </tbody> </table>	Code	Description	Qté	UOM	VM2311A0	PLAQUETTE COUVRE VIS	1.000	PCS
Code	Description	Qté	UOM										
VM2311A0	PLAQUETTE COUVRE VIS	1.000	PCS										
VM2450A	PASSE-PAROIS 3 TUBES		KVM2450A	KIT PASSE-PAROIS 3 TUYAUX	<table border="1"> <thead> <tr> <th>Code</th> <th>Description</th> <th>Qté</th> <th>UOM</th> </tr> </thead> <tbody> <tr> <td>VM2450A0</td> <td>PASSE-PAROIS 3 TUBES</td> <td>1.000</td> <td>PCS</td> </tr> </tbody> </table>	Code	Description	Qté	UOM	VM2450A0	PASSE-PAROIS 3 TUBES	1.000	PCS
Code	Description	Qté	UOM										
VM2450A0	PASSE-PAROIS 3 TUBES	1.000	PCS										

ASM2922A/0.D02 - Porte - FACE AVANT





ASM2922A/0.D02 - Porte - ARRIÈRE











COMPOSANT			PIÈCE DE RECHANGE																						
Code	Description	Image	Code	Description	Composants du kit																				
0B1111A	XEVC-0711-E LEFT EXT DOOR COLUMN		0B1111A0	XEVC-0711-E LEFT EXT DOOR COLUMN																					
0B1112A	0711 RIGHT - DOOR LEFT INT COLUMN		0B1112A2	0711 RIGHT - DOOR LEFT INT COLUMN																					
0B1113A	XEVC-0711-E RIGHT EXT DOOR COLUMN		0B1113A0	XEVC-0711-E RIGHT EXT DOOR COLUMN																					
0B1114A	0711 RIGHT - DOOR RIGHT INT COLUMN		OUTOFPRODUCTIO	ITEM OUT OF PRODUCTION																					
0B1122A	750MM DOOR LOWER FRAME SHAPE		K0B1122AR	KIT TRAVERS INF PORTE DROITE CHEFTOP MM	<table border="1"> <thead> <tr> <th>Code</th> <th>Description</th> <th>Qté</th> <th>UOM</th> </tr> </thead> <tbody> <tr> <td>0B1122A1</td> <td>750MM DOOR LOWER FRAME SHAPE</td> <td>1.000</td> <td>PCS</td> </tr> <tr> <td>RC1200A0</td> <td>RESSORT A COMPRESSIO N DE=4 DFIL=0.5</td> <td>2.000</td> <td>PCS</td> </tr> <tr> <td>VI1220A1</td> <td>VIS AUTOTARADE UX 4.2x12 TCB MARUTEX PRE</td> <td>1.000</td> <td>PCS</td> </tr> <tr> <td>VI1996A0</td> <td>VIS M5x35 TCEI ZN</td> <td>7.000</td> <td>PCS</td> </tr> </tbody> </table>	Code	Description	Qté	UOM	0B1122A1	750MM DOOR LOWER FRAME SHAPE	1.000	PCS	RC1200A0	RESSORT A COMPRESSIO N DE=4 DFIL=0.5	2.000	PCS	VI1220A1	VIS AUTOTARADE UX 4.2x12 TCB MARUTEX PRE	1.000	PCS	VI1996A0	VIS M5x35 TCEI ZN	7.000	PCS
Code	Description	Qté	UOM																						
0B1122A1	750MM DOOR LOWER FRAME SHAPE	1.000	PCS																						
RC1200A0	RESSORT A COMPRESSIO N DE=4 DFIL=0.5	2.000	PCS																						
VI1220A1	VIS AUTOTARADE UX 4.2x12 TCB MARUTEX PRE	1.000	PCS																						
VI1996A0	VIS M5x35 TCEI ZN	7.000	PCS																						

COMPOSANT			PIÈCE DE RECHANGE																																							
Code	Description	Image	Code	Description	Composants du kit																																					
0B1122A	750MM DOOR LOWER FRAME SHAPE		K0B1122AR	KIT TRAVERS INF PORTE DROITE CHEFTOP MM	<table border="1"> <thead> <tr> <th>Code</th> <th>Description</th> <th>Qté</th> <th>UOM</th> </tr> </thead> <tbody> <tr> <td>VM2259A1</td> <td>6 SERIES DOOR LOWER LEFT CAP</td> <td>1.000</td> <td>PCS</td> </tr> <tr> <td>VM2261A1</td> <td>MM DOOR LOWER RIGHT CAP</td> <td>1.000</td> <td>PCS</td> </tr> <tr> <td>VM2267A0</td> <td>GLISSEUR SYSTEME BLOCAGE VITRE INT.</td> <td>1.000</td> <td>PCS</td> </tr> <tr> <td>VM2269A0</td> <td>INTERNAL GLASS LOCKING SYSTEM CAP</td> <td>1.000</td> <td>PCS</td> </tr> <tr> <td>VM2274A0</td> <td>DOUILLE RAINUREE COURTE</td> <td>1.000</td> <td>PCS</td> </tr> <tr> <td>VM2305A0</td> <td>DOUILLE DE FIXATION BOUCHON PORTE MM</td> <td>7.000</td> <td>PCS</td> </tr> </tbody> </table>	Code	Description	Qté	UOM	VM2259A1	6 SERIES DOOR LOWER LEFT CAP	1.000	PCS	VM2261A1	MM DOOR LOWER RIGHT CAP	1.000	PCS	VM2267A0	GLISSEUR SYSTEME BLOCAGE VITRE INT.	1.000	PCS	VM2269A0	INTERNAL GLASS LOCKING SYSTEM CAP	1.000	PCS	VM2274A0	DOUILLE RAINUREE COURTE	1.000	PCS	VM2305A0	DOUILLE DE FIXATION BOUCHON PORTE MM	7.000	PCS									
			Code	Description	Qté	UOM																																				
VM2259A1	6 SERIES DOOR LOWER LEFT CAP	1.000	PCS																																							
VM2261A1	MM DOOR LOWER RIGHT CAP	1.000	PCS																																							
VM2267A0	GLISSEUR SYSTEME BLOCAGE VITRE INT.	1.000	PCS																																							
VM2269A0	INTERNAL GLASS LOCKING SYSTEM CAP	1.000	PCS																																							
VM2274A0	DOUILLE RAINUREE COURTE	1.000	PCS																																							
VM2305A0	DOUILLE DE FIXATION BOUCHON PORTE MM	7.000	PCS																																							
K0B1122AL	KIT TRAVERS INF PORTE GAUCHE CHEFTOP MM	<table border="1"> <thead> <tr> <th>Code</th> <th>Description</th> <th>Qté</th> <th>UOM</th> </tr> </thead> <tbody> <tr> <td>0B1122A1</td> <td>750MM DOOR LOWER FRAME SHAPE</td> <td>1.000</td> <td>PCS</td> </tr> <tr> <td>RC1200A0</td> <td>RESSORT A COMPRESSIO N DE=4 DFIL=0.5</td> <td>2.000</td> <td>PCS</td> </tr> <tr> <td>VI1220A1</td> <td>VIS AUTOTARADE UX 4.2x12 TCB MARUTEX PRE</td> <td>1.000</td> <td>PCS</td> </tr> <tr> <td>VI1996A0</td> <td>VIS M5x35 TCEI ZN</td> <td>7.000</td> <td>PCS</td> </tr> <tr> <td>VM1794A0</td> <td>PLAQUETTE NOIRE 250X4.8 PA66</td> <td>2.000</td> <td>PCS</td> </tr> <tr> <td>VM2103A0</td> <td>PLAQUETTE FERMETURE COLLIER</td> <td>2.000</td> <td>PCS</td> </tr> <tr> <td>VM2267A0</td> <td>GLISSEUR SYSTEME BLOCAGE VITRE INT.</td> <td>1.000</td> <td>PCS</td> </tr> <tr> <td>VM2269A0</td> <td>INTERNAL GLASS LOCKING SYSTEM CAP</td> <td>1.000</td> <td>PCS</td> </tr> <tr> <td>VM2274A0</td> <td>DOUILLE RAINUREE COURTE</td> <td>1.000</td> <td>PCS</td> </tr> </tbody> </table>	Code	Description	Qté	UOM	0B1122A1	750MM DOOR LOWER FRAME SHAPE	1.000	PCS	RC1200A0	RESSORT A COMPRESSIO N DE=4 DFIL=0.5	2.000	PCS	VI1220A1	VIS AUTOTARADE UX 4.2x12 TCB MARUTEX PRE	1.000	PCS	VI1996A0	VIS M5x35 TCEI ZN	7.000	PCS	VM1794A0	PLAQUETTE NOIRE 250X4.8 PA66	2.000	PCS	VM2103A0	PLAQUETTE FERMETURE COLLIER	2.000	PCS	VM2267A0	GLISSEUR SYSTEME BLOCAGE VITRE INT.	1.000	PCS	VM2269A0	INTERNAL GLASS LOCKING SYSTEM CAP	1.000	PCS	VM2274A0	DOUILLE RAINUREE COURTE	1.000	PCS
Code	Description	Qté	UOM																																							
0B1122A1	750MM DOOR LOWER FRAME SHAPE	1.000	PCS																																							
RC1200A0	RESSORT A COMPRESSIO N DE=4 DFIL=0.5	2.000	PCS																																							
VI1220A1	VIS AUTOTARADE UX 4.2x12 TCB MARUTEX PRE	1.000	PCS																																							
VI1996A0	VIS M5x35 TCEI ZN	7.000	PCS																																							
VM1794A0	PLAQUETTE NOIRE 250X4.8 PA66	2.000	PCS																																							
VM2103A0	PLAQUETTE FERMETURE COLLIER	2.000	PCS																																							
VM2267A0	GLISSEUR SYSTEME BLOCAGE VITRE INT.	1.000	PCS																																							
VM2269A0	INTERNAL GLASS LOCKING SYSTEM CAP	1.000	PCS																																							
VM2274A0	DOUILLE RAINUREE COURTE	1.000	PCS																																							





COMPOSANT			PIÈCE DE RECHANGE																		
Code	Description	Image	Code	Description	Composants du kit																
0B1122A	750MM DOOR LOWER FRAME SHAPE		K0B1122AL	KIT TRAVERS INF PORTE GAUCHE CHEFTOP MM	<table border="1"> <thead> <tr> <th>Code</th> <th>Description</th> <th>Qté</th> <th>UOM</th> </tr> </thead> <tbody> <tr> <td>VM2305A0</td> <td>DOUILLE DE FIXATION BOUCHON PORTE MM</td> <td>7.000</td> <td>PCS</td> </tr> <tr> <td>VM2384A0</td> <td>CAPUCHON INF DROIT PORTE MM GAUCHE</td> <td>1.000</td> <td>PCS</td> </tr> <tr> <td>VM2386A1</td> <td>LEFT MM DOOR LOWER LEFT CAP</td> <td>1.000</td> <td>PCS</td> </tr> </tbody> </table>	Code	Description	Qté	UOM	VM2305A0	DOUILLE DE FIXATION BOUCHON PORTE MM	7.000	PCS	VM2384A0	CAPUCHON INF DROIT PORTE MM GAUCHE	1.000	PCS	VM2386A1	LEFT MM DOOR LOWER LEFT CAP	1.000	PCS
Code	Description	Qté	UOM																		
VM2305A0	DOUILLE DE FIXATION BOUCHON PORTE MM	7.000	PCS																		
VM2384A0	CAPUCHON INF DROIT PORTE MM GAUCHE	1.000	PCS																		
VM2386A1	LEFT MM DOOR LOWER LEFT CAP	1.000	PCS																		
0B1167A	0B1167A1		OUTOFPRODUCTIO	ITEM OUT OF PRODUCTION																	
0B1216A	MM DOUBLE GLASS DOOR 750mm UPPER BEAM		0B1216A1	TRAVERS SUPERIEUR PORTE MM CT 2V																	
0B1217A	X_TRAVERS SUPERIEUR INT PORTE 750 S6 2V		OUTOFPRODUCTIO	ITEM OUT OF PRODUCTION																	
CE1285A	FERRITE EMI ROUND MOD. 2643801502		KCE1285A	KIT 2 PC BAQUE FERRITE ELECTROMAGN	<table border="1"> <thead> <tr> <th>Code</th> <th>Description</th> <th>Qté</th> <th>UOM</th> </tr> </thead> <tbody> <tr> <td>CE1285A0</td> <td>FERRITE EMI ROUND MOD. 2643801502</td> <td>2.000</td> <td>PCS</td> </tr> </tbody> </table>	Code	Description	Qté	UOM	CE1285A0	FERRITE EMI ROUND MOD. 2643801502	2.000	PCS								
Code	Description	Qté	UOM																		
CE1285A0	FERRITE EMI ROUND MOD. 2643801502	2.000	PCS																		

COMPOSANT			PIÈCE DE RECHANGE																														
Code	Description	Image	Code	Description	Composants du kit																												
CE1310A	POWER - CONTROL BOARD CONNECTING CABL		KCE1310A	KIT CABLE CONNEX PUISS-CONTR	<table border="1"> <thead> <tr> <th>Code</th> <th>Description</th> <th>Qté</th> <th>UOM</th> </tr> </thead> <tbody> <tr> <td>CE1285A0</td> <td>FERRITE EMI ROUND MOD. 2643801502</td> <td>1.000</td> <td>PCS</td> </tr> <tr> <td>CE1290A0</td> <td>BORNE FEMELLE EXTRACTIBLE CPF 5/4</td> <td>1.000</td> <td>PCS</td> </tr> <tr> <td>CE1455A0</td> <td>TIP END FITTING</td> <td>4.000</td> <td>PCS</td> </tr> <tr> <td>CE1725A0</td> <td>ROBOTICS SILICON PIPE 4x0.5 MMQ</td> <td>4.000</td> <td>M</td> </tr> <tr> <td>CE1735A0</td> <td>BORNE MINIFIT FEMELLE</td> <td>4.000</td> <td>PCS</td> </tr> <tr> <td>CE1755A0</td> <td>4 WAYS MALE MINIFIT CONNECTOR</td> <td>1.000</td> <td>PCS</td> </tr> </tbody> </table>	Code	Description	Qté	UOM	CE1285A0	FERRITE EMI ROUND MOD. 2643801502	1.000	PCS	CE1290A0	BORNE FEMELLE EXTRACTIBLE CPF 5/4	1.000	PCS	CE1455A0	TIP END FITTING	4.000	PCS	CE1725A0	ROBOTICS SILICON PIPE 4x0.5 MMQ	4.000	M	CE1735A0	BORNE MINIFIT FEMELLE	4.000	PCS	CE1755A0	4 WAYS MALE MINIFIT CONNECTOR	1.000	PCS
					Code	Description	Qté	UOM																									
					CE1285A0	FERRITE EMI ROUND MOD. 2643801502	1.000	PCS																									
					CE1290A0	BORNE FEMELLE EXTRACTIBLE CPF 5/4	1.000	PCS																									
					CE1455A0	TIP END FITTING	4.000	PCS																									
					CE1725A0	ROBOTICS SILICON PIPE 4x0.5 MMQ	4.000	M																									
					CE1735A0	BORNE MINIFIT FEMELLE	4.000	PCS																									
CE1755A0	4 WAYS MALE MINIFIT CONNECTOR	1.000	PCS																														
VE1030A	AIMANT D=22,9mm POUR MICROPORTE		KVE1030A	KIT MAGNET MICROPORTE - 2 PC	<table border="1"> <thead> <tr> <th>Code</th> <th>Description</th> <th>Qté</th> <th>UOM</th> </tr> </thead> <tbody> <tr> <td>VE1030A1</td> <td>AIMANT D=22,9mm POUR MICROPORTE</td> <td>2.000</td> <td>PCS</td> </tr> <tr> <td>VI1220A1</td> <td>VIS AUTOTARADE UX 4.2x12 TCB MARUTEX PRE</td> <td>1.000</td> <td>PCS</td> </tr> </tbody> </table>	Code	Description	Qté	UOM	VE1030A1	AIMANT D=22,9mm POUR MICROPORTE	2.000	PCS	VI1220A1	VIS AUTOTARADE UX 4.2x12 TCB MARUTEX PRE	1.000	PCS																
					Code	Description	Qté	UOM																									
			VE1030A1	AIMANT D=22,9mm POUR MICROPORTE	2.000	PCS																											
			VI1220A1	VIS AUTOTARADE UX 4.2x12 TCB MARUTEX PRE	1.000	PCS																											
			KVE1020B	KIT MICROPORTE	<table border="1"> <thead> <tr> <th>Code</th> <th>Description</th> <th>Qté</th> <th>UOM</th> </tr> </thead> <tbody> <tr> <td>CE1030A0</td> <td>FASTON FEMELLE 6.3X0.8 0.5-1 MMQ</td> <td>2.000</td> <td>PCS</td> </tr> <tr> <td>CE1660A0</td> <td>COUVERTURE FASTON FEMELLE 6.3X0.8</td> <td>2.000</td> <td>PCS</td> </tr> <tr> <td>CE1730A0</td> <td>CABLE PVC NP X AWG22 STYLE 2095</td> <td>0.150</td> <td>M</td> </tr> <tr> <td>CE1740A0</td> <td>BORNE MINIFIT MALE</td> <td>2.000</td> <td>PCS</td> </tr> <tr> <td>CE1745A0</td> <td>CONNECTEUR MINIFIT FEMELLE 2 VOIES</td> <td>1.000</td> <td>PCS</td> </tr> <tr> <td>VE1020B0</td> <td>CONTACT DE PORTE MAGNETIQUE AVEC MINIFIT</td> <td>1.000</td> <td>PCS</td> </tr> </tbody> </table>	Code	Description	Qté	UOM	CE1030A0	FASTON FEMELLE 6.3X0.8 0.5-1 MMQ	2.000	PCS	CE1660A0	COUVERTURE FASTON FEMELLE 6.3X0.8	2.000	PCS	CE1730A0	CABLE PVC NP X AWG22 STYLE 2095	0.150	M	CE1740A0	BORNE MINIFIT MALE	2.000	PCS	CE1745A0	CONNECTEUR MINIFIT FEMELLE 2 VOIES	1.000	PCS	VE1020B0	CONTACT DE PORTE MAGNETIQUE AVEC MINIFIT	1.000	PCS
					Code	Description	Qté	UOM																									
					CE1030A0	FASTON FEMELLE 6.3X0.8 0.5-1 MMQ	2.000	PCS																									
					CE1660A0	COUVERTURE FASTON FEMELLE 6.3X0.8	2.000	PCS																									
					CE1730A0	CABLE PVC NP X AWG22 STYLE 2095	0.150	M																									
					CE1740A0	BORNE MINIFIT MALE	2.000	PCS																									
CE1745A0	CONNECTEUR MINIFIT FEMELLE 2 VOIES	1.000			PCS																												
VE1020B0	CONTACT DE PORTE MAGNETIQUE AVEC MINIFIT	1.000			PCS																												

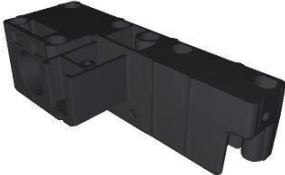

COMPOSANT			PIÈCE DE RECHANGE																																		
Code	Description	Image	Code	Description	Composants du kit																																
VE1030A	AIMANT D=22,9mm POUR MICROPORTE		KVE1020B	KIT MICROPORTE	<table border="1"> <thead> <tr> <th>Code</th> <th>Description</th> <th>Qté</th> <th>UOM</th> </tr> </thead> <tbody> <tr> <td>VE1030A1</td> <td>AIMANT D=22,9mm POUR MICROPORTE</td> <td>1.000</td> <td>PCS</td> </tr> <tr> <td>V1192A0</td> <td>BOULON M10X0.75 H3 LAITON NICHELÉ</td> <td>1.000</td> <td>PCS</td> </tr> </tbody> </table>	Code	Description	Qté	UOM	VE1030A1	AIMANT D=22,9mm POUR MICROPORTE	1.000	PCS	V1192A0	BOULON M10X0.75 H3 LAITON NICHELÉ	1.000	PCS																				
					Code	Description	Qté	UOM																													
VE1030A1	AIMANT D=22,9mm POUR MICROPORTE	1.000	PCS																																		
V1192A0	BOULON M10X0.75 H3 LAITON NICHELÉ	1.000	PCS																																		
V11996A	VIS M5x35 TCEI ZN		V11996A0	VIS M5x35 TCEI ZN																																	
VM2262A	MM DOOR UPPER RIGHT CAP		KVM2262A	KIT BOUCHON SUP DROIT PORTE MIND.MAPS	<table border="1"> <thead> <tr> <th>Code</th> <th>Description</th> <th>Qté</th> <th>UOM</th> </tr> </thead> <tbody> <tr> <td>VM2262A1</td> <td>MM DOOR UPPER RIGHT CAP</td> <td>1.000</td> <td>PCS</td> </tr> </tbody> </table>	Code	Description	Qté	UOM	VM2262A1	MM DOOR UPPER RIGHT CAP	1.000	PCS																								
Code	Description	Qté	UOM																																		
VM2262A1	MM DOOR UPPER RIGHT CAP	1.000	PCS																																		
VM2267A	GLISSEUR SYSTEME BLOPAGE VITRE INT.		KVM2386B	KIT BOUCHON INF GAUCHE PORTE MM -M L	<table border="1"> <thead> <tr> <th>Code</th> <th>Description</th> <th>Qté</th> <th>UOM</th> </tr> </thead> <tbody> <tr> <td>RC1200A0</td> <td>RESSORT A COMPRESSIO N DE=4 DFIL=0.5</td> <td>2.000</td> <td>PCS</td> </tr> <tr> <td>VE1030A1</td> <td>AIMANT D=22,9mm POUR MICROPORTE</td> <td>1.000</td> <td>PCS</td> </tr> <tr> <td>V11220A1</td> <td>VIS AUTOTARADE UX 4.2x12 TCB MARUTEX PRE</td> <td>1.000</td> <td>PCS</td> </tr> <tr> <td>V11930A1</td> <td>VIS 5X20 AGGLOMERE INOX</td> <td>4.000</td> <td>PCS</td> </tr> <tr> <td>V11996A0</td> <td>VIS M5x35 TCEI ZN</td> <td>4.000</td> <td>PCS</td> </tr> <tr> <td>VM2267A0</td> <td>GLISSEUR SYSTEME BLOPAGE VITRE INT.</td> <td>1.000</td> <td>PCS</td> </tr> <tr> <td>VM2268A0</td> <td>DOOR MAGNET COVER</td> <td>1.000</td> <td>PCS</td> </tr> </tbody> </table>	Code	Description	Qté	UOM	RC1200A0	RESSORT A COMPRESSIO N DE=4 DFIL=0.5	2.000	PCS	VE1030A1	AIMANT D=22,9mm POUR MICROPORTE	1.000	PCS	V11220A1	VIS AUTOTARADE UX 4.2x12 TCB MARUTEX PRE	1.000	PCS	V11930A1	VIS 5X20 AGGLOMERE INOX	4.000	PCS	V11996A0	VIS M5x35 TCEI ZN	4.000	PCS	VM2267A0	GLISSEUR SYSTEME BLOPAGE VITRE INT.	1.000	PCS	VM2268A0	DOOR MAGNET COVER	1.000	PCS
Code	Description	Qté	UOM																																		
RC1200A0	RESSORT A COMPRESSIO N DE=4 DFIL=0.5	2.000	PCS																																		
VE1030A1	AIMANT D=22,9mm POUR MICROPORTE	1.000	PCS																																		
V11220A1	VIS AUTOTARADE UX 4.2x12 TCB MARUTEX PRE	1.000	PCS																																		
V11930A1	VIS 5X20 AGGLOMERE INOX	4.000	PCS																																		
V11996A0	VIS M5x35 TCEI ZN	4.000	PCS																																		
VM2267A0	GLISSEUR SYSTEME BLOPAGE VITRE INT.	1.000	PCS																																		
VM2268A0	DOOR MAGNET COVER	1.000	PCS																																		



COMPOSANT			PIÈCE DE RECHANGE																																											
Code	Description	Image	Code	Description	Composants du kit																																									
VM2267A	GLISSEUR SYSTEME BLOCAGE VITRE INT.		KVM2386B	KIT BOUCHON INF GAUCHE PORTE MM -M L	<table border="1"> <thead> <tr> <th>Code</th> <th>Description</th> <th>Qté</th> <th>UOM</th> </tr> </thead> <tbody> <tr> <td>VM2269B0</td> <td>INNER GLASS FIXING CAP</td> <td>1.000</td> <td>PCS</td> </tr> <tr> <td>VM2305A0</td> <td>DOUILLE DE FIXATION BOUCHON PORTE MM</td> <td>4.000</td> <td>PCS</td> </tr> <tr> <td>VM2386B0</td> <td>BOUCHON INF GAUCHE PORTE S6 GAUCHE</td> <td>1.000</td> <td>PCS</td> </tr> </tbody> </table>	Code	Description	Qté	UOM	VM2269B0	INNER GLASS FIXING CAP	1.000	PCS	VM2305A0	DOUILLE DE FIXATION BOUCHON PORTE MM	4.000	PCS	VM2386B0	BOUCHON INF GAUCHE PORTE S6 GAUCHE	1.000	PCS																									
			Code	Description	Qté	UOM																																								
			VM2269B0	INNER GLASS FIXING CAP	1.000	PCS																																								
VM2305A0	DOUILLE DE FIXATION BOUCHON PORTE MM	4.000	PCS																																											
VM2386B0	BOUCHON INF GAUCHE PORTE S6 GAUCHE	1.000	PCS																																											
KVM2385B	KIT BOUCHON SUP GAUCHE PORTE MM -M L	<table border="1"> <thead> <tr> <th>Code</th> <th>Description</th> <th>Qté</th> <th>UOM</th> </tr> </thead> <tbody> <tr> <td>RC1200A0</td> <td>RESSORT A COMPRESSIO N DE=4 DFIL=0.5</td> <td>2.000</td> <td>PCS</td> </tr> <tr> <td>VE1030A1</td> <td>AIMANT D=22,9mm POUR MICROPORTE</td> <td>1.000</td> <td>PCS</td> </tr> <tr> <td>VI1220A1</td> <td>VIS AUTOTARADE UX 4.2x12 TCB MARUTEX PRE</td> <td>1.000</td> <td>PCS</td> </tr> <tr> <td>VI1930A1</td> <td>VIS 5X20 AGGLOMERE INOX</td> <td>4.000</td> <td>PCS</td> </tr> <tr> <td>VI1996A0</td> <td>VIS M5x35 TCEI ZN</td> <td>4.000</td> <td>PCS</td> </tr> <tr> <td>VM2267A0</td> <td>GLISSEUR SYSTEME BLOCAGE VITRE INT.</td> <td>1.000</td> <td>PCS</td> </tr> <tr> <td>VM2268A0</td> <td>DOOR MAGNET COVER</td> <td>1.000</td> <td>PCS</td> </tr> <tr> <td>VM2269B0</td> <td>INNER GLASS FIXING CAP</td> <td>1.000</td> <td>PCS</td> </tr> <tr> <td>VM2305A0</td> <td>DOUILLE DE FIXATION BOUCHON PORTE MM</td> <td>4.000</td> <td>PCS</td> </tr> <tr> <td>VM2385B0</td> <td>MM LEFT DOOR UPPER LEFT CAP</td> <td>1.000</td> <td>PCS</td> </tr> </tbody> </table>	Code	Description	Qté	UOM	RC1200A0	RESSORT A COMPRESSIO N DE=4 DFIL=0.5	2.000	PCS	VE1030A1	AIMANT D=22,9mm POUR MICROPORTE	1.000	PCS	VI1220A1	VIS AUTOTARADE UX 4.2x12 TCB MARUTEX PRE	1.000	PCS	VI1930A1	VIS 5X20 AGGLOMERE INOX	4.000	PCS	VI1996A0	VIS M5x35 TCEI ZN	4.000	PCS	VM2267A0	GLISSEUR SYSTEME BLOCAGE VITRE INT.	1.000	PCS	VM2268A0	DOOR MAGNET COVER	1.000	PCS	VM2269B0	INNER GLASS FIXING CAP	1.000	PCS	VM2305A0	DOUILLE DE FIXATION BOUCHON PORTE MM	4.000	PCS	VM2385B0	MM LEFT DOOR UPPER LEFT CAP	1.000	PCS
Code	Description	Qté	UOM																																											
RC1200A0	RESSORT A COMPRESSIO N DE=4 DFIL=0.5	2.000	PCS																																											
VE1030A1	AIMANT D=22,9mm POUR MICROPORTE	1.000	PCS																																											
VI1220A1	VIS AUTOTARADE UX 4.2x12 TCB MARUTEX PRE	1.000	PCS																																											
VI1930A1	VIS 5X20 AGGLOMERE INOX	4.000	PCS																																											
VI1996A0	VIS M5x35 TCEI ZN	4.000	PCS																																											
VM2267A0	GLISSEUR SYSTEME BLOCAGE VITRE INT.	1.000	PCS																																											
VM2268A0	DOOR MAGNET COVER	1.000	PCS																																											
VM2269B0	INNER GLASS FIXING CAP	1.000	PCS																																											
VM2305A0	DOUILLE DE FIXATION BOUCHON PORTE MM	4.000	PCS																																											
VM2385B0	MM LEFT DOOR UPPER LEFT CAP	1.000	PCS																																											
KVM2262B	KIT BOUCHON SUP DROIT PORTE MIND.MAPS -M	<table border="1"> <thead> <tr> <th>Code</th> <th>Description</th> <th>Qté</th> <th>UOM</th> </tr> </thead> <tbody> <tr> <td>RC1200A0</td> <td>RESSORT A COMPRESSIO N DE=4 DFIL=0.5</td> <td>2.000</td> <td>PCS</td> </tr> <tr> <td>VE1030A1</td> <td>AIMANT D=22,9mm POUR MICROPORTE</td> <td>1.000</td> <td>PCS</td> </tr> </tbody> </table>	Code	Description	Qté	UOM	RC1200A0	RESSORT A COMPRESSIO N DE=4 DFIL=0.5	2.000	PCS	VE1030A1	AIMANT D=22,9mm POUR MICROPORTE	1.000	PCS																																
Code	Description	Qté	UOM																																											
RC1200A0	RESSORT A COMPRESSIO N DE=4 DFIL=0.5	2.000	PCS																																											
VE1030A1	AIMANT D=22,9mm POUR MICROPORTE	1.000	PCS																																											

COMPOSANT			PIÈCE DE RECHANGE																																						
Code	Description	Image	Code	Description	Composants du kit																																				
VM2267A	GLISSEUR SYSTEME BLOCAGE VITRE INT.		KVM2262B	KIT BOUCHON SUP DROIT PORTE MIND.MAPS -M	<table border="1"> <thead> <tr> <th>Code</th> <th>Description</th> <th>Qté</th> <th>UOM</th> </tr> </thead> <tbody> <tr> <td>VI1220A1</td> <td>VIS AUTOTARADE UX 4.2x12 TCB MARUTEX PRE</td> <td>1.000</td> <td>PCS</td> </tr> <tr> <td>VI1930A1</td> <td>VIS 5X20 AGGLOMERE INOX</td> <td>4.000</td> <td>PCS</td> </tr> <tr> <td>VI1996A0</td> <td>VIS M5x35 TCEI ZN</td> <td>4.000</td> <td>PCS</td> </tr> <tr> <td>VM2262B0</td> <td>MM -M DOOR RIGHT UPPER CAP</td> <td>1.000</td> <td>PCS</td> </tr> <tr> <td>VM2267A0</td> <td>GLISSEUR SYSTEME BLOCAGE VITRE INT.</td> <td>1.000</td> <td>PCS</td> </tr> <tr> <td>VM2268A0</td> <td>DOOR MAGNET COVER</td> <td>1.000</td> <td>PCS</td> </tr> <tr> <td>VM2269B0</td> <td>INNER GLASS FIXING CAP</td> <td>1.000</td> <td>PCS</td> </tr> <tr> <td>VM2305A0</td> <td>DOUILLE DE FIXATION BOUCHON PORTE MM</td> <td>4.000</td> <td>PCS</td> </tr> </tbody> </table>	Code	Description	Qté	UOM	VI1220A1	VIS AUTOTARADE UX 4.2x12 TCB MARUTEX PRE	1.000	PCS	VI1930A1	VIS 5X20 AGGLOMERE INOX	4.000	PCS	VI1996A0	VIS M5x35 TCEI ZN	4.000	PCS	VM2262B0	MM -M DOOR RIGHT UPPER CAP	1.000	PCS	VM2267A0	GLISSEUR SYSTEME BLOCAGE VITRE INT.	1.000	PCS	VM2268A0	DOOR MAGNET COVER	1.000	PCS	VM2269B0	INNER GLASS FIXING CAP	1.000	PCS	VM2305A0	DOUILLE DE FIXATION BOUCHON PORTE MM	4.000	PCS
			Code	Description	Qté	UOM																																			
VI1220A1	VIS AUTOTARADE UX 4.2x12 TCB MARUTEX PRE	1.000	PCS																																						
VI1930A1	VIS 5X20 AGGLOMERE INOX	4.000	PCS																																						
VI1996A0	VIS M5x35 TCEI ZN	4.000	PCS																																						
VM2262B0	MM -M DOOR RIGHT UPPER CAP	1.000	PCS																																						
VM2267A0	GLISSEUR SYSTEME BLOCAGE VITRE INT.	1.000	PCS																																						
VM2268A0	DOOR MAGNET COVER	1.000	PCS																																						
VM2269B0	INNER GLASS FIXING CAP	1.000	PCS																																						
VM2305A0	DOUILLE DE FIXATION BOUCHON PORTE MM	4.000	PCS																																						
KVM2261B	KIT BOUCHON INF DROIT PORTE MIND.MAPS -M	<table border="1"> <thead> <tr> <th>Code</th> <th>Description</th> <th>Qté</th> <th>UOM</th> </tr> </thead> <tbody> <tr> <td>RC1200A0</td> <td>RESSORT A COMPRESSIO N DE=4 DFIL=0.5</td> <td>2.000</td> <td>PCS</td> </tr> <tr> <td>VE1030A1</td> <td>AIMANT D=22,9mm POUR MICROPORTE</td> <td>1.000</td> <td>PCS</td> </tr> <tr> <td>VI1220A1</td> <td>VIS AUTOTARADE UX 4.2x12 TCB MARUTEX PRE</td> <td>1.000</td> <td>PCS</td> </tr> <tr> <td>VI1930A1</td> <td>VIS 5X20 AGGLOMERE INOX</td> <td>4.000</td> <td>PCS</td> </tr> <tr> <td>VI1996A0</td> <td>VIS M5x35 TCEI ZN</td> <td>4.000</td> <td>PCS</td> </tr> <tr> <td>VM2261B0</td> <td>MM -M DOOR RIGHT LOWER CAP</td> <td>1.000</td> <td>PCS</td> </tr> <tr> <td>VM2267A0</td> <td>GLISSEUR SYSTEME BLOCAGE VITRE INT.</td> <td>1.000</td> <td>PCS</td> </tr> <tr> <td>VM2268A0</td> <td>DOOR MAGNET COVER</td> <td>1.000</td> <td>PCS</td> </tr> </tbody> </table>	Code	Description	Qté	UOM	RC1200A0	RESSORT A COMPRESSIO N DE=4 DFIL=0.5	2.000	PCS	VE1030A1	AIMANT D=22,9mm POUR MICROPORTE	1.000	PCS	VI1220A1	VIS AUTOTARADE UX 4.2x12 TCB MARUTEX PRE	1.000	PCS	VI1930A1	VIS 5X20 AGGLOMERE INOX	4.000	PCS	VI1996A0	VIS M5x35 TCEI ZN	4.000	PCS	VM2261B0	MM -M DOOR RIGHT LOWER CAP	1.000	PCS	VM2267A0	GLISSEUR SYSTEME BLOCAGE VITRE INT.	1.000	PCS	VM2268A0	DOOR MAGNET COVER	1.000	PCS			
Code	Description	Qté	UOM																																						
RC1200A0	RESSORT A COMPRESSIO N DE=4 DFIL=0.5	2.000	PCS																																						
VE1030A1	AIMANT D=22,9mm POUR MICROPORTE	1.000	PCS																																						
VI1220A1	VIS AUTOTARADE UX 4.2x12 TCB MARUTEX PRE	1.000	PCS																																						
VI1930A1	VIS 5X20 AGGLOMERE INOX	4.000	PCS																																						
VI1996A0	VIS M5x35 TCEI ZN	4.000	PCS																																						
VM2261B0	MM -M DOOR RIGHT LOWER CAP	1.000	PCS																																						
VM2267A0	GLISSEUR SYSTEME BLOCAGE VITRE INT.	1.000	PCS																																						
VM2268A0	DOOR MAGNET COVER	1.000	PCS																																						





COMPOSANT			PIÈCE DE RECHANGE														
Code	Description	Image	Code	Description	Composants du kit												
VM2267A	GLISSEUR SYSTEME BLOCAGE VITRE INT.		KVM2261B	KIT BOUCHON INF DROIT PORTE MIND.MAPS -M	<table border="1"> <thead> <tr> <th>Code</th> <th>Description</th> <th>Qté</th> <th>UOM</th> </tr> </thead> <tbody> <tr> <td>VM2269B0</td> <td>INNER GLASS FIXING CAP</td> <td>1.000</td> <td>PCS</td> </tr> <tr> <td>VM2305A0</td> <td>DOUILLE DE FIXATION BOUCHON PORTE MM</td> <td>4.000</td> <td>PCS</td> </tr> </tbody> </table>	Code	Description	Qté	UOM	VM2269B0	INNER GLASS FIXING CAP	1.000	PCS	VM2305A0	DOUILLE DE FIXATION BOUCHON PORTE MM	4.000	PCS
Code	Description	Qté	UOM														
VM2269B0	INNER GLASS FIXING CAP	1.000	PCS														
VM2305A0	DOUILLE DE FIXATION BOUCHON PORTE MM	4.000	PCS														
VM2268A	DOOR MAGNET COVER		KVM2268A	KIT BOUCHON COUVRE AIMANT PORTE	<table border="1"> <thead> <tr> <th>Code</th> <th>Description</th> <th>Qté</th> <th>UOM</th> </tr> </thead> <tbody> <tr> <td>VM2268A0</td> <td>DOOR MAGNET COVER</td> <td>1.000</td> <td>PCS</td> </tr> </tbody> </table>	Code	Description	Qté	UOM	VM2268A0	DOOR MAGNET COVER	1.000	PCS				
Code	Description	Qté	UOM														
VM2268A0	DOOR MAGNET COVER	1.000	PCS														
VM2269A	INTERNAL GLASS LOCKING SYSTEM CAP		KVM2269A	KIT BOUCHON SYSTEME BLOCAGE VITRE INTERI	<table border="1"> <thead> <tr> <th>Code</th> <th>Description</th> <th>Qté</th> <th>UOM</th> </tr> </thead> <tbody> <tr> <td>VM2269A0</td> <td>INTERNAL GLASS LOCKING SYSTEM CAP</td> <td>2.000</td> <td>PCS</td> </tr> </tbody> </table>	Code	Description	Qté	UOM	VM2269A0	INTERNAL GLASS LOCKING SYSTEM CAP	2.000	PCS				
Code	Description	Qté	UOM														
VM2269A0	INTERNAL GLASS LOCKING SYSTEM CAP	2.000	PCS														
VM2305A	DOUILLE DE FIXATION BOUCHON PORTE M		KVM2305A	KIT 10 LOQUETS FIXATION PORTE M	<table border="1"> <thead> <tr> <th>Code</th> <th>Description</th> <th>Qté</th> <th>UOM</th> </tr> </thead> <tbody> <tr> <td>VM2305A0</td> <td>DOUILLE DE FIXATION BOUCHON PORTE MM</td> <td>10.000</td> <td>PCS</td> </tr> </tbody> </table>	Code	Description	Qté	UOM	VM2305A0	DOUILLE DE FIXATION BOUCHON PORTE MM	10.000	PCS				
Code	Description	Qté	UOM														
VM2305A0	DOUILLE DE FIXATION BOUCHON PORTE MM	10.000	PCS														
VE1030A	AIMANT D=22,9mm POUR MICROPORTE		KVE1030A	KIT MAGNET MICROPORTE - 2 PC	<table border="1"> <thead> <tr> <th>Code</th> <th>Description</th> <th>Qté</th> <th>UOM</th> </tr> </thead> <tbody> <tr> <td>VE1030A1</td> <td>AIMANT D=22,9mm POUR MICROPORTE</td> <td>2.000</td> <td>PCS</td> </tr> <tr> <td>VI1220A1</td> <td>VIS AUTOTARADE UX 4.2x12 TCB MARUTEX PRE</td> <td>1.000</td> <td>PCS</td> </tr> </tbody> </table>	Code	Description	Qté	UOM	VE1030A1	AIMANT D=22,9mm POUR MICROPORTE	2.000	PCS	VI1220A1	VIS AUTOTARADE UX 4.2x12 TCB MARUTEX PRE	1.000	PCS
Code	Description	Qté	UOM														
VE1030A1	AIMANT D=22,9mm POUR MICROPORTE	2.000	PCS														
VI1220A1	VIS AUTOTARADE UX 4.2x12 TCB MARUTEX PRE	1.000	PCS														
			KVE1020B	KIT MICROPORTE	<table border="1"> <thead> <tr> <th>Code</th> <th>Description</th> <th>Qté</th> <th>UOM</th> </tr> </thead> <tbody> <tr> <td>CE1030A0</td> <td>FASTON FEMELLE 6.3X0.8 0.5-1 MMQ</td> <td>2.000</td> <td>PCS</td> </tr> </tbody> </table>	Code	Description	Qté	UOM	CE1030A0	FASTON FEMELLE 6.3X0.8 0.5-1 MMQ	2.000	PCS				
Code	Description	Qté	UOM														
CE1030A0	FASTON FEMELLE 6.3X0.8 0.5-1 MMQ	2.000	PCS														





COMPOSANT			PIÈCE DE RECHANGE																																		
Code	Description	Image	Code	Description	Composants du kit																																
VE1030A	AIMANT D=22,9mm POUR MICROPORTE		KVE1020B	KIT MICROPORTE	<table border="1"> <thead> <tr> <th>Code</th> <th>Description</th> <th>Qté</th> <th>UOM</th> </tr> </thead> <tbody> <tr> <td>CE1660A0</td> <td>COUVERTURE FASTON FEMELLE 6.3X0.8</td> <td>2.000</td> <td>PCS</td> </tr> <tr> <td>CE1730A0</td> <td>CABLE PVC NP X AWG22 STYLE 2095</td> <td>0.150</td> <td>M</td> </tr> <tr> <td>CE1740A0</td> <td>BORNE MINIFIT MALE</td> <td>2.000</td> <td>PCS</td> </tr> <tr> <td>CE1745A0</td> <td>CONNECTEUR MINIFIT FEMELLE 2 VOIES</td> <td>1.000</td> <td>PCS</td> </tr> <tr> <td>VE1020B0</td> <td>CONTACT DE PORTE MAGNETIQUE AVEC MINIFIT</td> <td>1.000</td> <td>PCS</td> </tr> <tr> <td>VE1030A1</td> <td>AIMANT D=22,9mm POUR MICROPORTE</td> <td>1.000</td> <td>PCS</td> </tr> <tr> <td>VI1192A0</td> <td>BOULON M10X0.75 H3 LAITON NICKELE</td> <td>1.000</td> <td>PCS</td> </tr> </tbody> </table>	Code	Description	Qté	UOM	CE1660A0	COUVERTURE FASTON FEMELLE 6.3X0.8	2.000	PCS	CE1730A0	CABLE PVC NP X AWG22 STYLE 2095	0.150	M	CE1740A0	BORNE MINIFIT MALE	2.000	PCS	CE1745A0	CONNECTEUR MINIFIT FEMELLE 2 VOIES	1.000	PCS	VE1020B0	CONTACT DE PORTE MAGNETIQUE AVEC MINIFIT	1.000	PCS	VE1030A1	AIMANT D=22,9mm POUR MICROPORTE	1.000	PCS	VI1192A0	BOULON M10X0.75 H3 LAITON NICKELE	1.000	PCS
					Code	Description	Qté	UOM																													
					CE1660A0	COUVERTURE FASTON FEMELLE 6.3X0.8	2.000	PCS																													
					CE1730A0	CABLE PVC NP X AWG22 STYLE 2095	0.150	M																													
					CE1740A0	BORNE MINIFIT MALE	2.000	PCS																													
					CE1745A0	CONNECTEUR MINIFIT FEMELLE 2 VOIES	1.000	PCS																													
					VE1020B0	CONTACT DE PORTE MAGNETIQUE AVEC MINIFIT	1.000	PCS																													
					VE1030A1	AIMANT D=22,9mm POUR MICROPORTE	1.000	PCS																													
VI1192A0	BOULON M10X0.75 H3 LAITON NICKELE	1.000	PCS																																		
VI1996A	VIS M5x35 TCEI ZN		VI1996A0	VIS M5x35 TCEI ZN																																	
VM2261A	MM DOOR LOWER RIGHT CAP		KVM2261A	KIT BOUCHON INF DROIT PORTE MIND.MAPS	<table border="1"> <thead> <tr> <th>Code</th> <th>Description</th> <th>Qté</th> <th>UOM</th> </tr> </thead> <tbody> <tr> <td>VI1996A0</td> <td>VIS M5x35 TCEI ZN</td> <td>3.000</td> <td>PCS</td> </tr> <tr> <td>VM2261A1</td> <td>MM DOOR LOWER RIGHT CAP</td> <td>1.000</td> <td>PCS</td> </tr> <tr> <td>VM2305A0</td> <td>DOUILLE DE FIXATION BOUCHON PORTE MM</td> <td>3.000</td> <td>PCS</td> </tr> </tbody> </table>	Code	Description	Qté	UOM	VI1996A0	VIS M5x35 TCEI ZN	3.000	PCS	VM2261A1	MM DOOR LOWER RIGHT CAP	1.000	PCS	VM2305A0	DOUILLE DE FIXATION BOUCHON PORTE MM	3.000	PCS																
					Code	Description	Qté	UOM																													
			VI1996A0	VIS M5x35 TCEI ZN	3.000	PCS																															
			VM2261A1	MM DOOR LOWER RIGHT CAP	1.000	PCS																															
VM2305A0	DOUILLE DE FIXATION BOUCHON PORTE MM	3.000	PCS																																		
K0B1126AR	KIT TRAVERS INF PORTE DROITE BAKERTOP MM	<table border="1"> <thead> <tr> <th>Code</th> <th>Description</th> <th>Qté</th> <th>UOM</th> </tr> </thead> <tbody> <tr> <td>0B1126A1</td> <td>860mm DOOR LOWER FRAME SHAPE</td> <td>1.000</td> <td>PCS</td> </tr> </tbody> </table>	Code	Description	Qté	UOM	0B1126A1	860mm DOOR LOWER FRAME SHAPE	1.000	PCS																											
		Code	Description	Qté	UOM																																
0B1126A1	860mm DOOR LOWER FRAME SHAPE	1.000	PCS																																		

COMPOSANT			PIÈCE DE RECHANGE																																																																													
Code	Description	Image	Code	Description	Composants du kit																																																																											
VM2261A	MM DOOR LOWER RIGHT CAP		K0B1126AR	KIT TRAVERS INF PORTE DROITE BAKERTOP MM	<table border="1"> <thead> <tr> <th>Code</th> <th>Description</th> <th>Qté</th> <th>UOM</th> </tr> </thead> <tbody> <tr> <td>RC1200A0</td> <td>RESSORT A COMPRESSIO N DE=4 DFIL=0.5</td> <td>2.000</td> <td>PCS</td> </tr> <tr> <td>V11220A1</td> <td>VIS AUTOTARADE UX 4.2x12 TCB MARUTEX PRE</td> <td>1.000</td> <td>PCS</td> </tr> <tr> <td>V11996A0</td> <td>VIS M5x35 TCEI ZN</td> <td>7.000</td> <td>PCS</td> </tr> <tr> <td>VM1794A0</td> <td>PLAQUETTE NOIRE 250X4.8 PA66</td> <td>2.000</td> <td>PCS</td> </tr> <tr> <td>VM2103A0</td> <td>PLAQUETTE FERMETURE COLLIER</td> <td>2.000</td> <td>PCS</td> </tr> <tr> <td>VM2259A1</td> <td>6 SERIES DOOR LOWER LEFT CAP</td> <td>1.000</td> <td>PCS</td> </tr> <tr> <td>VM2261A1</td> <td>MM DOOR LOWER RIGHT CAP</td> <td>1.000</td> <td>PCS</td> </tr> <tr> <td>VM2267A0</td> <td>GLISSEUR SYSTEME BLOCAGE VITRE INT.</td> <td>1.000</td> <td>PCS</td> </tr> <tr> <td>VM2269A0</td> <td>INTERNAL GLASS LOCKING SYSTEM CAP</td> <td>1.000</td> <td>PCS</td> </tr> <tr> <td>VM2274A0</td> <td>DOUILLE RAINUREE COURTE</td> <td>1.000</td> <td>PCS</td> </tr> <tr> <td>VM2305A0</td> <td>DOUILLE DE FIXATION BOUCHON PORTE MM</td> <td>7.000</td> <td>PCS</td> </tr> </tbody> </table>	Code	Description	Qté	UOM	RC1200A0	RESSORT A COMPRESSIO N DE=4 DFIL=0.5	2.000	PCS	V11220A1	VIS AUTOTARADE UX 4.2x12 TCB MARUTEX PRE	1.000	PCS	V11996A0	VIS M5x35 TCEI ZN	7.000	PCS	VM1794A0	PLAQUETTE NOIRE 250X4.8 PA66	2.000	PCS	VM2103A0	PLAQUETTE FERMETURE COLLIER	2.000	PCS	VM2259A1	6 SERIES DOOR LOWER LEFT CAP	1.000	PCS	VM2261A1	MM DOOR LOWER RIGHT CAP	1.000	PCS	VM2267A0	GLISSEUR SYSTEME BLOCAGE VITRE INT.	1.000	PCS	VM2269A0	INTERNAL GLASS LOCKING SYSTEM CAP	1.000	PCS	VM2274A0	DOUILLE RAINUREE COURTE	1.000	PCS	VM2305A0	DOUILLE DE FIXATION BOUCHON PORTE MM	7.000	PCS	K0B1126AL	KIT TRAVERS INF PORTE GAUCHE EU ET 2/1MM	<table border="1"> <thead> <tr> <th>Code</th> <th>Description</th> <th>Qté</th> <th>UOM</th> </tr> </thead> <tbody> <tr> <td>0B1126A1</td> <td>860mm DOOR LOWER FRAME SHAPE</td> <td>1.000</td> <td>PCS</td> </tr> <tr> <td>RC1200A0</td> <td>RESSORT A COMPRESSIO N DE=4 DFIL=0.5</td> <td>2.000</td> <td>PCS</td> </tr> <tr> <td>V11220A1</td> <td>VIS AUTOTARADE UX 4.2x12 TCB MARUTEX PRE</td> <td>1.000</td> <td>PCS</td> </tr> <tr> <td>V11996A0</td> <td>VIS M5x35 TCEI ZN</td> <td>7.000</td> <td>PCS</td> </tr> <tr> <td>VM1794A0</td> <td>PLAQUETTE NOIRE 250X4.8 PA66</td> <td>2.000</td> <td>PCS</td> </tr> </tbody> </table>	Code	Description	Qté	UOM	0B1126A1	860mm DOOR LOWER FRAME SHAPE	1.000	PCS	RC1200A0	RESSORT A COMPRESSIO N DE=4 DFIL=0.5	2.000	PCS	V11220A1	VIS AUTOTARADE UX 4.2x12 TCB MARUTEX PRE	1.000	PCS	V11996A0	VIS M5x35 TCEI ZN	7.000	PCS	VM1794A0	PLAQUETTE NOIRE 250X4.8 PA66	2.000	PCS
			Code	Description	Qté	UOM																																																																										
RC1200A0	RESSORT A COMPRESSIO N DE=4 DFIL=0.5	2.000	PCS																																																																													
V11220A1	VIS AUTOTARADE UX 4.2x12 TCB MARUTEX PRE	1.000	PCS																																																																													
V11996A0	VIS M5x35 TCEI ZN	7.000	PCS																																																																													
VM1794A0	PLAQUETTE NOIRE 250X4.8 PA66	2.000	PCS																																																																													
VM2103A0	PLAQUETTE FERMETURE COLLIER	2.000	PCS																																																																													
VM2259A1	6 SERIES DOOR LOWER LEFT CAP	1.000	PCS																																																																													
VM2261A1	MM DOOR LOWER RIGHT CAP	1.000	PCS																																																																													
VM2267A0	GLISSEUR SYSTEME BLOCAGE VITRE INT.	1.000	PCS																																																																													
VM2269A0	INTERNAL GLASS LOCKING SYSTEM CAP	1.000	PCS																																																																													
VM2274A0	DOUILLE RAINUREE COURTE	1.000	PCS																																																																													
VM2305A0	DOUILLE DE FIXATION BOUCHON PORTE MM	7.000	PCS																																																																													
Code	Description	Qté	UOM																																																																													
0B1126A1	860mm DOOR LOWER FRAME SHAPE	1.000	PCS																																																																													
RC1200A0	RESSORT A COMPRESSIO N DE=4 DFIL=0.5	2.000	PCS																																																																													
V11220A1	VIS AUTOTARADE UX 4.2x12 TCB MARUTEX PRE	1.000	PCS																																																																													
V11996A0	VIS M5x35 TCEI ZN	7.000	PCS																																																																													
VM1794A0	PLAQUETTE NOIRE 250X4.8 PA66	2.000	PCS																																																																													

COMPOSANT			PIÈCE DE RECHANGE																																			
Code	Description	Image	Code	Description	Composants du kit																																	
VM2261A	MM DOOR LOWER RIGHT CAP		K0B1126AL	KIT TRAVERS INF PORTE GAUCHE EU ET 2/1MM	<table border="1"> <thead> <tr> <th>Code</th> <th>Description</th> <th>Qté</th> <th>UOM</th> </tr> </thead> <tbody> <tr> <td>VM2103A0</td> <td>PLAQUETTE FERMETURE COLLIER</td> <td>2.000</td> <td>PCS</td> </tr> <tr> <td>VM2267A0</td> <td>GLISSEUR SYSTEME BLOCAGE VITRE INT.</td> <td>1.000</td> <td>PCS</td> </tr> <tr> <td>VM2269A0</td> <td>INTERNAL GLASS LOCKING SYSTEM CAP</td> <td>1.000</td> <td>PCS</td> </tr> <tr> <td>VM2274A0</td> <td>DOUILLE RAINUREE COURTE</td> <td>1.000</td> <td>PCS</td> </tr> <tr> <td>VM2305A0</td> <td>DOUILLE DE FIXATION BOUCHON PORTE MM</td> <td>7.000</td> <td>PCS</td> </tr> <tr> <td>VM2384A0</td> <td>CAPUCHON INF DROIT PORTE MM GAUCHE</td> <td>1.000</td> <td>PCS</td> </tr> <tr> <td>VM2386A1</td> <td>LEFT MM DOOR LOWER LEFT CAP</td> <td>1.000</td> <td>PCS</td> </tr> </tbody> </table>	Code	Description	Qté	UOM	VM2103A0	PLAQUETTE FERMETURE COLLIER	2.000	PCS	VM2267A0	GLISSEUR SYSTEME BLOCAGE VITRE INT.	1.000	PCS	VM2269A0	INTERNAL GLASS LOCKING SYSTEM CAP	1.000	PCS	VM2274A0	DOUILLE RAINUREE COURTE	1.000	PCS	VM2305A0	DOUILLE DE FIXATION BOUCHON PORTE MM	7.000	PCS	VM2384A0	CAPUCHON INF DROIT PORTE MM GAUCHE	1.000	PCS	VM2386A1	LEFT MM DOOR LOWER LEFT CAP	1.000	PCS	
			Code	Description	Qté	UOM																																
VM2103A0	PLAQUETTE FERMETURE COLLIER	2.000	PCS																																			
VM2267A0	GLISSEUR SYSTEME BLOCAGE VITRE INT.	1.000	PCS																																			
VM2269A0	INTERNAL GLASS LOCKING SYSTEM CAP	1.000	PCS																																			
VM2274A0	DOUILLE RAINUREE COURTE	1.000	PCS																																			
VM2305A0	DOUILLE DE FIXATION BOUCHON PORTE MM	7.000	PCS																																			
VM2384A0	CAPUCHON INF DROIT PORTE MM GAUCHE	1.000	PCS																																			
VM2386A1	LEFT MM DOOR LOWER LEFT CAP	1.000	PCS																																			
K0B1122AR	KIT TRAVERS INF PORTE DROITE CHEFTOP MM	<table border="1"> <thead> <tr> <th>Code</th> <th>Description</th> <th>Qté</th> <th>UOM</th> </tr> </thead> <tbody> <tr> <td>0B1122A1</td> <td>750MM DOOR LOWER FRAME SHAPE</td> <td>1.000</td> <td>PCS</td> </tr> <tr> <td>RC1200A0</td> <td>RESSORT A COMPRESSIO N DE=4 DFIL=0.5</td> <td>2.000</td> <td>PCS</td> </tr> <tr> <td>VI1220A1</td> <td>VIS AUTOTARADE UX 4.2x12 TCB MARUTEX PRE</td> <td>1.000</td> <td>PCS</td> </tr> <tr> <td>VI1996A0</td> <td>VIS M5x35 TCEI ZN</td> <td>7.000</td> <td>PCS</td> </tr> <tr> <td>VM2259A1</td> <td>6 SERIES DOOR LOWER LEFT CAP</td> <td>1.000</td> <td>PCS</td> </tr> <tr> <td>VM2261A1</td> <td>MM DOOR LOWER RIGHT CAP</td> <td>1.000</td> <td>PCS</td> </tr> <tr> <td>VM2267A0</td> <td>GLISSEUR SYSTEME BLOCAGE VITRE INT.</td> <td>1.000</td> <td>PCS</td> </tr> <tr> <td>VM2269A0</td> <td>INTERNAL GLASS LOCKING SYSTEM CAP</td> <td>1.000</td> <td>PCS</td> </tr> </tbody> </table>	Code	Description	Qté	UOM	0B1122A1	750MM DOOR LOWER FRAME SHAPE	1.000	PCS	RC1200A0	RESSORT A COMPRESSIO N DE=4 DFIL=0.5	2.000	PCS	VI1220A1	VIS AUTOTARADE UX 4.2x12 TCB MARUTEX PRE	1.000	PCS	VI1996A0	VIS M5x35 TCEI ZN	7.000	PCS	VM2259A1	6 SERIES DOOR LOWER LEFT CAP	1.000	PCS	VM2261A1	MM DOOR LOWER RIGHT CAP	1.000	PCS	VM2267A0	GLISSEUR SYSTEME BLOCAGE VITRE INT.	1.000	PCS	VM2269A0	INTERNAL GLASS LOCKING SYSTEM CAP	1.000	PCS
Code	Description	Qté	UOM																																			
0B1122A1	750MM DOOR LOWER FRAME SHAPE	1.000	PCS																																			
RC1200A0	RESSORT A COMPRESSIO N DE=4 DFIL=0.5	2.000	PCS																																			
VI1220A1	VIS AUTOTARADE UX 4.2x12 TCB MARUTEX PRE	1.000	PCS																																			
VI1996A0	VIS M5x35 TCEI ZN	7.000	PCS																																			
VM2259A1	6 SERIES DOOR LOWER LEFT CAP	1.000	PCS																																			
VM2261A1	MM DOOR LOWER RIGHT CAP	1.000	PCS																																			
VM2267A0	GLISSEUR SYSTEME BLOCAGE VITRE INT.	1.000	PCS																																			
VM2269A0	INTERNAL GLASS LOCKING SYSTEM CAP	1.000	PCS																																			

COMPOSANT			PIÈCE DE RECHANGE																																																			
Code	Description	Image	Code	Description	Composants du kit																																																	
VM2261A	MM DOOR LOWER RIGHT CAP		K0B1122AR	KIT TRAVERS INF PORTE DROITE CHEFTOP MM	<table border="1"> <thead> <tr> <th>Code</th> <th>Description</th> <th>Qté</th> <th>UOM</th> </tr> </thead> <tbody> <tr> <td>VM2274A0</td> <td>DOUILLE RAINUREE COURTE</td> <td>1.000</td> <td>PCS</td> </tr> <tr> <td>VM2305A0</td> <td>DOUILLE DE FIXATION BOUCHON PORTE MM</td> <td>7.000</td> <td>PCS</td> </tr> </tbody> </table>	Code	Description	Qté	UOM	VM2274A0	DOUILLE RAINUREE COURTE	1.000	PCS	VM2305A0	DOUILLE DE FIXATION BOUCHON PORTE MM	7.000	PCS																																					
			Code	Description	Qté	UOM																																																
VM2274A0	DOUILLE RAINUREE COURTE	1.000	PCS																																																			
VM2305A0	DOUILLE DE FIXATION BOUCHON PORTE MM	7.000	PCS																																																			
K0B1122AL	KIT TRAVERS INF PORTE GAUCHE CHEFTOP MM	<table border="1"> <thead> <tr> <th>Code</th> <th>Description</th> <th>Qté</th> <th>UOM</th> </tr> </thead> <tbody> <tr> <td>0B1122A1</td> <td>750MM DOOR LOWER FRAME SHAPE</td> <td>1.000</td> <td>PCS</td> </tr> <tr> <td>RC1200A0</td> <td>RESSORT A COMPRESSIO N DE=4 DFIL=0.5</td> <td>2.000</td> <td>PCS</td> </tr> <tr> <td>VI1220A1</td> <td>VIS AUTOTARADE UX 4.2x12 TCB MARUTEX PRE</td> <td>1.000</td> <td>PCS</td> </tr> <tr> <td>VI1996A0</td> <td>VIS M5x35 TCEJ ZN</td> <td>7.000</td> <td>PCS</td> </tr> <tr> <td>VM1794A0</td> <td>PLAQUETTE NOIRE 250X4.8 PA66</td> <td>2.000</td> <td>PCS</td> </tr> <tr> <td>VM2103A0</td> <td>PLAQUETTE FERMETURE COLLIER</td> <td>2.000</td> <td>PCS</td> </tr> <tr> <td>VM2267A0</td> <td>GLISSEUR SYSTEME BLOCAGE VITRE INT.</td> <td>1.000</td> <td>PCS</td> </tr> <tr> <td>VM2269A0</td> <td>INTERNAL GLASS LOCKING SYSTEM CAP</td> <td>1.000</td> <td>PCS</td> </tr> <tr> <td>VM2274A0</td> <td>DOUILLE RAINUREE COURTE</td> <td>1.000</td> <td>PCS</td> </tr> <tr> <td>VM2305A0</td> <td>DOUILLE DE FIXATION BOUCHON PORTE MM</td> <td>7.000</td> <td>PCS</td> </tr> <tr> <td>VM2384A0</td> <td>CAPUCHON INF DROIT PORTE MM GAUCHE</td> <td>1.000</td> <td>PCS</td> </tr> <tr> <td>VM2386A1</td> <td>LEFT MM DOOR LOWER LEFT CAP</td> <td>1.000</td> <td>PCS</td> </tr> </tbody> </table>	Code	Description	Qté	UOM	0B1122A1	750MM DOOR LOWER FRAME SHAPE	1.000	PCS	RC1200A0	RESSORT A COMPRESSIO N DE=4 DFIL=0.5	2.000	PCS	VI1220A1	VIS AUTOTARADE UX 4.2x12 TCB MARUTEX PRE	1.000	PCS	VI1996A0	VIS M5x35 TCEJ ZN	7.000	PCS	VM1794A0	PLAQUETTE NOIRE 250X4.8 PA66	2.000	PCS	VM2103A0	PLAQUETTE FERMETURE COLLIER	2.000	PCS	VM2267A0	GLISSEUR SYSTEME BLOCAGE VITRE INT.	1.000	PCS	VM2269A0	INTERNAL GLASS LOCKING SYSTEM CAP	1.000	PCS	VM2274A0	DOUILLE RAINUREE COURTE	1.000	PCS	VM2305A0	DOUILLE DE FIXATION BOUCHON PORTE MM	7.000	PCS	VM2384A0	CAPUCHON INF DROIT PORTE MM GAUCHE	1.000	PCS	VM2386A1	LEFT MM DOOR LOWER LEFT CAP	1.000	PCS
Code	Description	Qté	UOM																																																			
0B1122A1	750MM DOOR LOWER FRAME SHAPE	1.000	PCS																																																			
RC1200A0	RESSORT A COMPRESSIO N DE=4 DFIL=0.5	2.000	PCS																																																			
VI1220A1	VIS AUTOTARADE UX 4.2x12 TCB MARUTEX PRE	1.000	PCS																																																			
VI1996A0	VIS M5x35 TCEJ ZN	7.000	PCS																																																			
VM1794A0	PLAQUETTE NOIRE 250X4.8 PA66	2.000	PCS																																																			
VM2103A0	PLAQUETTE FERMETURE COLLIER	2.000	PCS																																																			
VM2267A0	GLISSEUR SYSTEME BLOCAGE VITRE INT.	1.000	PCS																																																			
VM2269A0	INTERNAL GLASS LOCKING SYSTEM CAP	1.000	PCS																																																			
VM2274A0	DOUILLE RAINUREE COURTE	1.000	PCS																																																			
VM2305A0	DOUILLE DE FIXATION BOUCHON PORTE MM	7.000	PCS																																																			
VM2384A0	CAPUCHON INF DROIT PORTE MM GAUCHE	1.000	PCS																																																			
VM2386A1	LEFT MM DOOR LOWER LEFT CAP	1.000	PCS																																																			



COMPOSANT			PIÈCE DE RECHANGE																																														
Code	Description	Image	Code	Description	Composants du kit																																												
VM2267A	GLISSEUR SYSTEME BLOCAGE VITRE INT.		KVM2386B	KIT BOUCHON INF GAUCHE PORTE MM -M L	<table border="1"> <thead> <tr> <th>Code</th> <th>Description</th> <th>Qté</th> <th>UOM</th> </tr> </thead> <tbody> <tr> <td>RC1200A0</td> <td>RESSORT A COMPRESSIO N DE=4 DFIL=0.5</td> <td>2.000</td> <td>PCS</td> </tr> <tr> <td>VE1030A1</td> <td>AIMANT D=22,9mm POUR MICROPORTE</td> <td>1.000</td> <td>PCS</td> </tr> <tr> <td>VI1220A1</td> <td>VIS AUTOTARADE UX 4.2x12 TCB MARUTEX PRE</td> <td>1.000</td> <td>PCS</td> </tr> <tr> <td>VI1930A1</td> <td>VIS 5X20 AGGLOMERE INOX</td> <td>4.000</td> <td>PCS</td> </tr> <tr> <td>VI1996A0</td> <td>VIS M5x35 TCEI ZN</td> <td>4.000</td> <td>PCS</td> </tr> <tr> <td>VM2267A0</td> <td>GLISSEUR SYSTEME BLOCAGE VITRE INT.</td> <td>1.000</td> <td>PCS</td> </tr> <tr> <td>VM2268A0</td> <td>DOOR MAGNET COVER</td> <td>1.000</td> <td>PCS</td> </tr> <tr> <td>VM2269B0</td> <td>INNER GLASS FIXING CAP</td> <td>1.000</td> <td>PCS</td> </tr> <tr> <td>VM2305A0</td> <td>DOUILLE DE FIXATION BOUCHON PORTE MM</td> <td>4.000</td> <td>PCS</td> </tr> <tr> <td>VM2386B0</td> <td>BOUCHON INF GAUCHE PORTE S6 GAUCHE</td> <td>1.000</td> <td>PCS</td> </tr> </tbody> </table>	Code	Description	Qté	UOM	RC1200A0	RESSORT A COMPRESSIO N DE=4 DFIL=0.5	2.000	PCS	VE1030A1	AIMANT D=22,9mm POUR MICROPORTE	1.000	PCS	VI1220A1	VIS AUTOTARADE UX 4.2x12 TCB MARUTEX PRE	1.000	PCS	VI1930A1	VIS 5X20 AGGLOMERE INOX	4.000	PCS	VI1996A0	VIS M5x35 TCEI ZN	4.000	PCS	VM2267A0	GLISSEUR SYSTEME BLOCAGE VITRE INT.	1.000	PCS	VM2268A0	DOOR MAGNET COVER	1.000	PCS	VM2269B0	INNER GLASS FIXING CAP	1.000	PCS	VM2305A0	DOUILLE DE FIXATION BOUCHON PORTE MM	4.000	PCS	VM2386B0	BOUCHON INF GAUCHE PORTE S6 GAUCHE	1.000	PCS
			Code	Description	Qté	UOM																																											
RC1200A0	RESSORT A COMPRESSIO N DE=4 DFIL=0.5	2.000	PCS																																														
VE1030A1	AIMANT D=22,9mm POUR MICROPORTE	1.000	PCS																																														
VI1220A1	VIS AUTOTARADE UX 4.2x12 TCB MARUTEX PRE	1.000	PCS																																														
VI1930A1	VIS 5X20 AGGLOMERE INOX	4.000	PCS																																														
VI1996A0	VIS M5x35 TCEI ZN	4.000	PCS																																														
VM2267A0	GLISSEUR SYSTEME BLOCAGE VITRE INT.	1.000	PCS																																														
VM2268A0	DOOR MAGNET COVER	1.000	PCS																																														
VM2269B0	INNER GLASS FIXING CAP	1.000	PCS																																														
VM2305A0	DOUILLE DE FIXATION BOUCHON PORTE MM	4.000	PCS																																														
VM2386B0	BOUCHON INF GAUCHE PORTE S6 GAUCHE	1.000	PCS																																														
KVM2385B	KIT BOUCHON SUP GAUCHE PORTE MM -M L	<table border="1"> <thead> <tr> <th>Code</th> <th>Description</th> <th>Qté</th> <th>UOM</th> </tr> </thead> <tbody> <tr> <td>RC1200A0</td> <td>RESSORT A COMPRESSIO N DE=4 DFIL=0.5</td> <td>2.000</td> <td>PCS</td> </tr> <tr> <td>VE1030A1</td> <td>AIMANT D=22,9mm POUR MICROPORTE</td> <td>1.000</td> <td>PCS</td> </tr> <tr> <td>VI1220A1</td> <td>VIS AUTOTARADE UX 4.2x12 TCB MARUTEX PRE</td> <td>1.000</td> <td>PCS</td> </tr> <tr> <td>VI1930A1</td> <td>VIS 5X20 AGGLOMERE INOX</td> <td>4.000</td> <td>PCS</td> </tr> <tr> <td>VI1996A0</td> <td>VIS M5x35 TCEI ZN</td> <td>4.000</td> <td>PCS</td> </tr> </tbody> </table>	Code	Description	Qté	UOM	RC1200A0	RESSORT A COMPRESSIO N DE=4 DFIL=0.5	2.000	PCS	VE1030A1	AIMANT D=22,9mm POUR MICROPORTE	1.000	PCS	VI1220A1	VIS AUTOTARADE UX 4.2x12 TCB MARUTEX PRE	1.000	PCS	VI1930A1	VIS 5X20 AGGLOMERE INOX	4.000	PCS	VI1996A0	VIS M5x35 TCEI ZN	4.000	PCS																							
Code	Description	Qté	UOM																																														
RC1200A0	RESSORT A COMPRESSIO N DE=4 DFIL=0.5	2.000	PCS																																														
VE1030A1	AIMANT D=22,9mm POUR MICROPORTE	1.000	PCS																																														
VI1220A1	VIS AUTOTARADE UX 4.2x12 TCB MARUTEX PRE	1.000	PCS																																														
VI1930A1	VIS 5X20 AGGLOMERE INOX	4.000	PCS																																														
VI1996A0	VIS M5x35 TCEI ZN	4.000	PCS																																														

COMPOSANT			PIÈCE DE RECHANGE																																											
Code	Description	Image	Code	Description	Composants du kit																																									
VM2267A	GLISSEUR SYSTEME BLOCAGE VITRE INT.		KVM2385B	KIT BOUCHON SUP GAUCHE PORTE MM -M L	<table border="1"> <thead> <tr> <th>Code</th> <th>Description</th> <th>Qté</th> <th>UOM</th> </tr> </thead> <tbody> <tr> <td>VM2267A0</td> <td>GLISSEUR SYSTEME BLOCAGE VITRE INT.</td> <td>1.000</td> <td>PCS</td> </tr> <tr> <td>VM2268A0</td> <td>DOOR MAGNET COVER</td> <td>1.000</td> <td>PCS</td> </tr> <tr> <td>VM2269B0</td> <td>INNER GLASS FIXING CAP</td> <td>1.000</td> <td>PCS</td> </tr> <tr> <td>VM2305A0</td> <td>DOUILLE DE FIXATION BOUCHON PORTE MM</td> <td>4.000</td> <td>PCS</td> </tr> <tr> <td>VM2385B0</td> <td>MM LEFT DOOR UPPER LEFT CAP</td> <td>1.000</td> <td>PCS</td> </tr> </tbody> </table>	Code	Description	Qté	UOM	VM2267A0	GLISSEUR SYSTEME BLOCAGE VITRE INT.	1.000	PCS	VM2268A0	DOOR MAGNET COVER	1.000	PCS	VM2269B0	INNER GLASS FIXING CAP	1.000	PCS	VM2305A0	DOUILLE DE FIXATION BOUCHON PORTE MM	4.000	PCS	VM2385B0	MM LEFT DOOR UPPER LEFT CAP	1.000	PCS																	
			Code	Description	Qté	UOM																																								
VM2267A0	GLISSEUR SYSTEME BLOCAGE VITRE INT.	1.000	PCS																																											
VM2268A0	DOOR MAGNET COVER	1.000	PCS																																											
VM2269B0	INNER GLASS FIXING CAP	1.000	PCS																																											
VM2305A0	DOUILLE DE FIXATION BOUCHON PORTE MM	4.000	PCS																																											
VM2385B0	MM LEFT DOOR UPPER LEFT CAP	1.000	PCS																																											
KVM2262B	KIT BOUCHON SUP DROIT PORTE MIND.MAPS -M	<table border="1"> <thead> <tr> <th>Code</th> <th>Description</th> <th>Qté</th> <th>UOM</th> </tr> </thead> <tbody> <tr> <td>RC1200A0</td> <td>RESSORT A COMPRESSIO N DE=4 DFIL=0.5</td> <td>2.000</td> <td>PCS</td> </tr> <tr> <td>VE1030A1</td> <td>AIMANT D=22,9mm POUR MICROPORTE</td> <td>1.000</td> <td>PCS</td> </tr> <tr> <td>VI1220A1</td> <td>VIS AUTOTARADE UX 4.2x12 TCB MARUTEX PRE</td> <td>1.000</td> <td>PCS</td> </tr> <tr> <td>VI1930A1</td> <td>VIS 5X20 AGGLOMERE INOX</td> <td>4.000</td> <td>PCS</td> </tr> <tr> <td>VI1996A0</td> <td>VIS M5x35 TCEI ZN</td> <td>4.000</td> <td>PCS</td> </tr> <tr> <td>VM2262B0</td> <td>MM -M DOOR RIGHT UPPER CAP</td> <td>1.000</td> <td>PCS</td> </tr> <tr> <td>VM2267A0</td> <td>GLISSEUR SYSTEME BLOCAGE VITRE INT.</td> <td>1.000</td> <td>PCS</td> </tr> <tr> <td>VM2268A0</td> <td>DOOR MAGNET COVER</td> <td>1.000</td> <td>PCS</td> </tr> <tr> <td>VM2269B0</td> <td>INNER GLASS FIXING CAP</td> <td>1.000</td> <td>PCS</td> </tr> <tr> <td>VM2305A0</td> <td>DOUILLE DE FIXATION BOUCHON PORTE MM</td> <td>4.000</td> <td>PCS</td> </tr> </tbody> </table>	Code	Description	Qté	UOM	RC1200A0	RESSORT A COMPRESSIO N DE=4 DFIL=0.5	2.000	PCS	VE1030A1	AIMANT D=22,9mm POUR MICROPORTE	1.000	PCS	VI1220A1	VIS AUTOTARADE UX 4.2x12 TCB MARUTEX PRE	1.000	PCS	VI1930A1	VIS 5X20 AGGLOMERE INOX	4.000	PCS	VI1996A0	VIS M5x35 TCEI ZN	4.000	PCS	VM2262B0	MM -M DOOR RIGHT UPPER CAP	1.000	PCS	VM2267A0	GLISSEUR SYSTEME BLOCAGE VITRE INT.	1.000	PCS	VM2268A0	DOOR MAGNET COVER	1.000	PCS	VM2269B0	INNER GLASS FIXING CAP	1.000	PCS	VM2305A0	DOUILLE DE FIXATION BOUCHON PORTE MM	4.000	PCS
Code	Description	Qté	UOM																																											
RC1200A0	RESSORT A COMPRESSIO N DE=4 DFIL=0.5	2.000	PCS																																											
VE1030A1	AIMANT D=22,9mm POUR MICROPORTE	1.000	PCS																																											
VI1220A1	VIS AUTOTARADE UX 4.2x12 TCB MARUTEX PRE	1.000	PCS																																											
VI1930A1	VIS 5X20 AGGLOMERE INOX	4.000	PCS																																											
VI1996A0	VIS M5x35 TCEI ZN	4.000	PCS																																											
VM2262B0	MM -M DOOR RIGHT UPPER CAP	1.000	PCS																																											
VM2267A0	GLISSEUR SYSTEME BLOCAGE VITRE INT.	1.000	PCS																																											
VM2268A0	DOOR MAGNET COVER	1.000	PCS																																											
VM2269B0	INNER GLASS FIXING CAP	1.000	PCS																																											
VM2305A0	DOUILLE DE FIXATION BOUCHON PORTE MM	4.000	PCS																																											

COMPOSANT			PIÈCE DE RECHANGE																																														
Code	Description	Image	Code	Description	Composants du kit																																												
VM2267A	GLISSEUR SYSTEME BLOCAGE VITRE INT.		KVM2261B	KIT BOUCHON INF DROIT PORTE MIND.MAPS -M	<table border="1"> <thead> <tr> <th>Code</th> <th>Description</th> <th>Qté</th> <th>UOM</th> </tr> </thead> <tbody> <tr> <td>RC1200A0</td> <td>RESSORT A COMPRESSIO N DE=4 DFIL=0.5</td> <td>2.000</td> <td>PCS</td> </tr> <tr> <td>VE1030A1</td> <td>AIMANT D=22,9mm POUR MICROPORTE</td> <td>1.000</td> <td>PCS</td> </tr> <tr> <td>VI1220A1</td> <td>VIS AUTOTARADE UX 4.2x12 TCB MARUTEX PRE</td> <td>1.000</td> <td>PCS</td> </tr> <tr> <td>VI1930A1</td> <td>VIS 5X20 AGGLOMERE INOX</td> <td>4.000</td> <td>PCS</td> </tr> <tr> <td>VI1996A0</td> <td>VIS M5x35 TCEI ZN</td> <td>4.000</td> <td>PCS</td> </tr> <tr> <td>VM2261B0</td> <td>MM -M DOOR RIGHT LOWER CAP</td> <td>1.000</td> <td>PCS</td> </tr> <tr> <td>VM2267A0</td> <td>GLISSEUR SYSTEME BLOCAGE VITRE INT.</td> <td>1.000</td> <td>PCS</td> </tr> <tr> <td>VM2268A0</td> <td>DOOR MAGNET COVER</td> <td>1.000</td> <td>PCS</td> </tr> <tr> <td>VM2269B0</td> <td>INNER GLASS FIXING CAP</td> <td>1.000</td> <td>PCS</td> </tr> <tr> <td>VM2305A0</td> <td>DOUILLE DE FIXATION BOUCHON PORTE MM</td> <td>4.000</td> <td>PCS</td> </tr> </tbody> </table>	Code	Description	Qté	UOM	RC1200A0	RESSORT A COMPRESSIO N DE=4 DFIL=0.5	2.000	PCS	VE1030A1	AIMANT D=22,9mm POUR MICROPORTE	1.000	PCS	VI1220A1	VIS AUTOTARADE UX 4.2x12 TCB MARUTEX PRE	1.000	PCS	VI1930A1	VIS 5X20 AGGLOMERE INOX	4.000	PCS	VI1996A0	VIS M5x35 TCEI ZN	4.000	PCS	VM2261B0	MM -M DOOR RIGHT LOWER CAP	1.000	PCS	VM2267A0	GLISSEUR SYSTEME BLOCAGE VITRE INT.	1.000	PCS	VM2268A0	DOOR MAGNET COVER	1.000	PCS	VM2269B0	INNER GLASS FIXING CAP	1.000	PCS	VM2305A0	DOUILLE DE FIXATION BOUCHON PORTE MM	4.000	PCS
					Code	Description	Qté	UOM																																									
					RC1200A0	RESSORT A COMPRESSIO N DE=4 DFIL=0.5	2.000	PCS																																									
					VE1030A1	AIMANT D=22,9mm POUR MICROPORTE	1.000	PCS																																									
					VI1220A1	VIS AUTOTARADE UX 4.2x12 TCB MARUTEX PRE	1.000	PCS																																									
					VI1930A1	VIS 5X20 AGGLOMERE INOX	4.000	PCS																																									
					VI1996A0	VIS M5x35 TCEI ZN	4.000	PCS																																									
					VM2261B0	MM -M DOOR RIGHT LOWER CAP	1.000	PCS																																									
					VM2267A0	GLISSEUR SYSTEME BLOCAGE VITRE INT.	1.000	PCS																																									
					VM2268A0	DOOR MAGNET COVER	1.000	PCS																																									
VM2269B0	INNER GLASS FIXING CAP	1.000	PCS																																														
VM2305A0	DOUILLE DE FIXATION BOUCHON PORTE MM	4.000	PCS																																														
VM2268A	DOOR MAGNET COVER		KVM2268A	KIT BOUCHON COUVRE AIMANT PORTE	<table border="1"> <thead> <tr> <th>Code</th> <th>Description</th> <th>Qté</th> <th>UOM</th> </tr> </thead> <tbody> <tr> <td>VM2268A0</td> <td>DOOR MAGNET COVER</td> <td>1.000</td> <td>PCS</td> </tr> </tbody> </table>	Code	Description	Qté	UOM	VM2268A0	DOOR MAGNET COVER	1.000	PCS																																				
Code	Description	Qté	UOM																																														
VM2268A0	DOOR MAGNET COVER	1.000	PCS																																														
VM2269A	INTERNAL GLASS LOCKING SYSTEM CAP		KVM2269A	KIT BOUCHON SYSTEME BLOCAGE VITRE INTERI	<table border="1"> <thead> <tr> <th>Code</th> <th>Description</th> <th>Qté</th> <th>UOM</th> </tr> </thead> <tbody> <tr> <td>VM2269A0</td> <td>INTERNAL GLASS LOCKING SYSTEM CAP</td> <td>2.000</td> <td>PCS</td> </tr> </tbody> </table>	Code	Description	Qté	UOM	VM2269A0	INTERNAL GLASS LOCKING SYSTEM CAP	2.000	PCS																																				
Code	Description	Qté	UOM																																														
VM2269A0	INTERNAL GLASS LOCKING SYSTEM CAP	2.000	PCS																																														



COMPOSANT			PIÈCE DE RECHANGE										
Code	Description	Image	Code	Description	Composants du kit								
VM2305A	DOUILLE DE FIXATION BOUCHON PORTE M		KVM2305A	KIT 10 LOQUETS FIXATION PORTE M	<table border="1"> <thead> <tr> <th>Code</th> <th>Description</th> <th>Qté</th> <th>UOM</th> </tr> </thead> <tbody> <tr> <td>VM2305A0</td> <td>DOUILLE DE FIXATION BOUCHON PORTE MM</td> <td>10.000</td> <td>PCS</td> </tr> </tbody> </table>	Code	Description	Qté	UOM	VM2305A0	DOUILLE DE FIXATION BOUCHON PORTE MM	10.000	PCS
Code	Description	Qté	UOM										
VM2305A0	DOUILLE DE FIXATION BOUCHON PORTE MM	10.000	PCS										
VI1996A	VIS M5x35 TCEI ZN		VI1996A0	VIS M5x35 TCEI ZN									
VM2260A	6 SERIES DOOR UPPER LEFT CAP		KVM2260A	KIT BOUCHON SUP GAUCHE PORTE MIND.MAPS	<table border="1"> <thead> <tr> <th>Code</th> <th>Description</th> <th>Qté</th> <th>UOM</th> </tr> </thead> <tbody> <tr> <td>VM2260A1</td> <td>6 SERIES DOOR UPPER LEFT CAP</td> <td>1.000</td> <td>PCS</td> </tr> </tbody> </table>	Code	Description	Qté	UOM	VM2260A1	6 SERIES DOOR UPPER LEFT CAP	1.000	PCS
Code	Description	Qté	UOM										
VM2260A1	6 SERIES DOOR UPPER LEFT CAP	1.000	PCS										
VM2275A	DOUILLE LISSE COURTE		KVM2275A	KIT BUSELURE LISSE VM2275A0	<table border="1"> <thead> <tr> <th>Code</th> <th>Description</th> <th>Qté</th> <th>UOM</th> </tr> </thead> <tbody> <tr> <td>VM2275A0</td> <td>DOUILLE LISSE COURT</td> <td>1.000</td> <td>PCS</td> </tr> </tbody> </table>	Code	Description	Qté	UOM	VM2275A0	DOUILLE LISSE COURT	1.000	PCS
Code	Description	Qté	UOM										
VM2275A0	DOUILLE LISSE COURT	1.000	PCS										
VM2305A	DOUILLE DE FIXATION BOUCHON PORTE M		KVM2305A	KIT 10 LOQUETS FIXATION PORTE M	<table border="1"> <thead> <tr> <th>Code</th> <th>Description</th> <th>Qté</th> <th>UOM</th> </tr> </thead> <tbody> <tr> <td>VM2305A0</td> <td>DOUILLE DE FIXATION BOUCHON PORTE MM</td> <td>10.000</td> <td>PCS</td> </tr> </tbody> </table>	Code	Description	Qté	UOM	VM2305A0	DOUILLE DE FIXATION BOUCHON PORTE MM	10.000	PCS
Code	Description	Qté	UOM										
VM2305A0	DOUILLE DE FIXATION BOUCHON PORTE MM	10.000	PCS										

COMPOSANT			PIÈCE DE RECHANGE																																														
Code	Description	Image	Code	Description	Composants du kit																																												
VI1996A	VIS M5x35 TCEI ZN		VI1996A0	VIS M5x35 TCEI ZN																																													
VM2259A	6 SERIES DOOR LOWER LEFT CAP		KVM2259A	KIT BOUCHON PORTE INFERIEUR GAUCHE MM	<table border="1"> <thead> <tr> <th>Code</th> <th>Description</th> <th>Qté</th> <th>UOM</th> </tr> </thead> <tbody> <tr> <td>VI1996A0</td> <td>VIS M5x35 TCEI ZN</td> <td>3.000</td> <td>PCS</td> </tr> <tr> <td>VM2259A1</td> <td>6 SERIES DOOR LOWER LEFT CAP</td> <td>1.000</td> <td>PCS</td> </tr> <tr> <td>VM2305A0</td> <td>DOUILLE DE FIXATION BOUCHON PORTE MM</td> <td>3.000</td> <td>PCS</td> </tr> </tbody> </table>	Code	Description	Qté	UOM	VI1996A0	VIS M5x35 TCEI ZN	3.000	PCS	VM2259A1	6 SERIES DOOR LOWER LEFT CAP	1.000	PCS	VM2305A0	DOUILLE DE FIXATION BOUCHON PORTE MM	3.000	PCS																												
Code	Description	Qté	UOM																																														
VI1996A0	VIS M5x35 TCEI ZN	3.000	PCS																																														
VM2259A1	6 SERIES DOOR LOWER LEFT CAP	1.000	PCS																																														
VM2305A0	DOUILLE DE FIXATION BOUCHON PORTE MM	3.000	PCS																																														
			K0B1126AR	KIT TRAVERS INF PORTE DROITE BAKERTOP MM	<table border="1"> <thead> <tr> <th>Code</th> <th>Description</th> <th>Qté</th> <th>UOM</th> </tr> </thead> <tbody> <tr> <td>0B1126A1</td> <td>860mm DOOR LOWER FRAME SHAPE</td> <td>1.000</td> <td>PCS</td> </tr> <tr> <td>RC1200A0</td> <td>RESSORT A COMPRESSIO N DE=4 DFIL=0.5</td> <td>2.000</td> <td>PCS</td> </tr> <tr> <td>VI1220A1</td> <td>VIS AUTOTARADE UX 4.2x12 TCB MARUTEX PRE</td> <td>1.000</td> <td>PCS</td> </tr> <tr> <td>VI1996A0</td> <td>VIS M5x35 TCEI ZN</td> <td>7.000</td> <td>PCS</td> </tr> <tr> <td>VM1794A0</td> <td>PLAQUETTE NOIRE 250X4.8 PA66</td> <td>2.000</td> <td>PCS</td> </tr> <tr> <td>VM2103A0</td> <td>PLAQUETTE FERMETURE COLLIER</td> <td>2.000</td> <td>PCS</td> </tr> <tr> <td>VM2259A1</td> <td>6 SERIES DOOR LOWER LEFT CAP</td> <td>1.000</td> <td>PCS</td> </tr> <tr> <td>VM2261A1</td> <td>MM DOOR LOWER RIGHT CAP</td> <td>1.000</td> <td>PCS</td> </tr> <tr> <td>VM2267A0</td> <td>GLISSEUR SYSTEME BLOCAGE VITRE INT.</td> <td>1.000</td> <td>PCS</td> </tr> <tr> <td>VM2269A0</td> <td>INTERNAL GLASS LOCKING SYSTEM CAP</td> <td>1.000</td> <td>PCS</td> </tr> </tbody> </table>	Code	Description	Qté	UOM	0B1126A1	860mm DOOR LOWER FRAME SHAPE	1.000	PCS	RC1200A0	RESSORT A COMPRESSIO N DE=4 DFIL=0.5	2.000	PCS	VI1220A1	VIS AUTOTARADE UX 4.2x12 TCB MARUTEX PRE	1.000	PCS	VI1996A0	VIS M5x35 TCEI ZN	7.000	PCS	VM1794A0	PLAQUETTE NOIRE 250X4.8 PA66	2.000	PCS	VM2103A0	PLAQUETTE FERMETURE COLLIER	2.000	PCS	VM2259A1	6 SERIES DOOR LOWER LEFT CAP	1.000	PCS	VM2261A1	MM DOOR LOWER RIGHT CAP	1.000	PCS	VM2267A0	GLISSEUR SYSTEME BLOCAGE VITRE INT.	1.000	PCS	VM2269A0	INTERNAL GLASS LOCKING SYSTEM CAP	1.000	PCS
Code	Description	Qté	UOM																																														
0B1126A1	860mm DOOR LOWER FRAME SHAPE	1.000	PCS																																														
RC1200A0	RESSORT A COMPRESSIO N DE=4 DFIL=0.5	2.000	PCS																																														
VI1220A1	VIS AUTOTARADE UX 4.2x12 TCB MARUTEX PRE	1.000	PCS																																														
VI1996A0	VIS M5x35 TCEI ZN	7.000	PCS																																														
VM1794A0	PLAQUETTE NOIRE 250X4.8 PA66	2.000	PCS																																														
VM2103A0	PLAQUETTE FERMETURE COLLIER	2.000	PCS																																														
VM2259A1	6 SERIES DOOR LOWER LEFT CAP	1.000	PCS																																														
VM2261A1	MM DOOR LOWER RIGHT CAP	1.000	PCS																																														
VM2267A0	GLISSEUR SYSTEME BLOCAGE VITRE INT.	1.000	PCS																																														
VM2269A0	INTERNAL GLASS LOCKING SYSTEM CAP	1.000	PCS																																														

COMPOSANT			PIÈCE DE RECHANGE																																																			
Code	Description	Image	Code	Description	Composants du kit																																																	
VM2259A	6 SERIES DOOR LOWER LEFT CAP		K0B1126AR	KIT TRAVERS INF PORTE DROITE BAKERTOP MM	<table border="1"> <thead> <tr> <th>Code</th> <th>Description</th> <th>Qté</th> <th>UOM</th> </tr> </thead> <tbody> <tr> <td>VM2274A0</td> <td>DOUILLE RAINUREE COURTE</td> <td>1.000</td> <td>PCS</td> </tr> <tr> <td>VM2305A0</td> <td>DOUILLE DE FIXATION BOUCHON PORTE MM</td> <td>7.000</td> <td>PCS</td> </tr> </tbody> </table>	Code	Description	Qté	UOM	VM2274A0	DOUILLE RAINUREE COURTE	1.000	PCS	VM2305A0	DOUILLE DE FIXATION BOUCHON PORTE MM	7.000	PCS																																					
			Code	Description	Qté	UOM																																																
VM2274A0	DOUILLE RAINUREE COURTE	1.000	PCS																																																			
VM2305A0	DOUILLE DE FIXATION BOUCHON PORTE MM	7.000	PCS																																																			
K0B1126AL	KIT TRAVERS INF PORTE GAUCHE EU ET 2/1MM	<table border="1"> <thead> <tr> <th>Code</th> <th>Description</th> <th>Qté</th> <th>UOM</th> </tr> </thead> <tbody> <tr> <td>0B1126A1</td> <td>860mm DOOR LOWER FRAME SHAPE</td> <td>1.000</td> <td>PCS</td> </tr> <tr> <td>RC1200A0</td> <td>RESSORT A COMPRESSIO N DE=4 DFIL=0.5</td> <td>2.000</td> <td>PCS</td> </tr> <tr> <td>VI1220A1</td> <td>VIS AUTOTARADE UX 4.2x12 TCB MARUTEX PRE</td> <td>1.000</td> <td>PCS</td> </tr> <tr> <td>VI1996A0</td> <td>VIS M5x35 TCEJ ZN</td> <td>7.000</td> <td>PCS</td> </tr> <tr> <td>VM1794A0</td> <td>PLAQUETTE NOIRE 250X4.8 PA66</td> <td>2.000</td> <td>PCS</td> </tr> <tr> <td>VM2103A0</td> <td>PLAQUETTE FERMETURE COLLIER</td> <td>2.000</td> <td>PCS</td> </tr> <tr> <td>VM2267A0</td> <td>GLISSEUR SYSTEME BLOCAGE VITRE INT.</td> <td>1.000</td> <td>PCS</td> </tr> <tr> <td>VM2269A0</td> <td>INTERNAL GLASS LOCKING SYSTEM CAP</td> <td>1.000</td> <td>PCS</td> </tr> <tr> <td>VM2274A0</td> <td>DOUILLE RAINUREE COURTE</td> <td>1.000</td> <td>PCS</td> </tr> <tr> <td>VM2305A0</td> <td>DOUILLE DE FIXATION BOUCHON PORTE MM</td> <td>7.000</td> <td>PCS</td> </tr> <tr> <td>VM2384A0</td> <td>CAPUCHON INF DROIT PORTE MM GAUCHE</td> <td>1.000</td> <td>PCS</td> </tr> <tr> <td>VM2386A1</td> <td>LEFT MM DOOR LOWER LEFT CAP</td> <td>1.000</td> <td>PCS</td> </tr> </tbody> </table>	Code	Description	Qté	UOM	0B1126A1	860mm DOOR LOWER FRAME SHAPE	1.000	PCS	RC1200A0	RESSORT A COMPRESSIO N DE=4 DFIL=0.5	2.000	PCS	VI1220A1	VIS AUTOTARADE UX 4.2x12 TCB MARUTEX PRE	1.000	PCS	VI1996A0	VIS M5x35 TCEJ ZN	7.000	PCS	VM1794A0	PLAQUETTE NOIRE 250X4.8 PA66	2.000	PCS	VM2103A0	PLAQUETTE FERMETURE COLLIER	2.000	PCS	VM2267A0	GLISSEUR SYSTEME BLOCAGE VITRE INT.	1.000	PCS	VM2269A0	INTERNAL GLASS LOCKING SYSTEM CAP	1.000	PCS	VM2274A0	DOUILLE RAINUREE COURTE	1.000	PCS	VM2305A0	DOUILLE DE FIXATION BOUCHON PORTE MM	7.000	PCS	VM2384A0	CAPUCHON INF DROIT PORTE MM GAUCHE	1.000	PCS	VM2386A1	LEFT MM DOOR LOWER LEFT CAP	1.000	PCS
Code	Description	Qté	UOM																																																			
0B1126A1	860mm DOOR LOWER FRAME SHAPE	1.000	PCS																																																			
RC1200A0	RESSORT A COMPRESSIO N DE=4 DFIL=0.5	2.000	PCS																																																			
VI1220A1	VIS AUTOTARADE UX 4.2x12 TCB MARUTEX PRE	1.000	PCS																																																			
VI1996A0	VIS M5x35 TCEJ ZN	7.000	PCS																																																			
VM1794A0	PLAQUETTE NOIRE 250X4.8 PA66	2.000	PCS																																																			
VM2103A0	PLAQUETTE FERMETURE COLLIER	2.000	PCS																																																			
VM2267A0	GLISSEUR SYSTEME BLOCAGE VITRE INT.	1.000	PCS																																																			
VM2269A0	INTERNAL GLASS LOCKING SYSTEM CAP	1.000	PCS																																																			
VM2274A0	DOUILLE RAINUREE COURTE	1.000	PCS																																																			
VM2305A0	DOUILLE DE FIXATION BOUCHON PORTE MM	7.000	PCS																																																			
VM2384A0	CAPUCHON INF DROIT PORTE MM GAUCHE	1.000	PCS																																																			
VM2386A1	LEFT MM DOOR LOWER LEFT CAP	1.000	PCS																																																			





COMPOSANT			PIÈCE DE RECHANGE																																																																													
Code	Description	Image	Code	Description	Composants du kit																																																																											
VM2259A	6 SERIES DOOR LOWER LEFT CAP		K0B1122AR	KIT TRAVERS INF PORTE DROITE CHEFTOP MM	<table border="1"> <thead> <tr> <th>Code</th> <th>Description</th> <th>Qté</th> <th>UOM</th> </tr> </thead> <tbody> <tr> <td>0B1122A1</td> <td>750MM DOOR LOWER FRAME SHAPE</td> <td>1.000</td> <td>PCS</td> </tr> <tr> <td>RC1200A0</td> <td>RESSORT A COMPRESSIO N DE=4 DFIL=0.5</td> <td>2.000</td> <td>PCS</td> </tr> <tr> <td>V11220A1</td> <td>VIS AUTOTARADE UX 4.2x12 TCB MARUTEX PRE</td> <td>1.000</td> <td>PCS</td> </tr> <tr> <td>VI1996A0</td> <td>VIS M5x35 TCEI ZN</td> <td>7.000</td> <td>PCS</td> </tr> <tr> <td>VM2259A1</td> <td>6 SERIES DOOR LOWER LEFT CAP</td> <td>1.000</td> <td>PCS</td> </tr> <tr> <td>VM2261A1</td> <td>MM DOOR LOWER RIGHT CAP</td> <td>1.000</td> <td>PCS</td> </tr> <tr> <td>VM2267A0</td> <td>GLISSEUR SYSTEME BLOCAGE VITRE INT.</td> <td>1.000</td> <td>PCS</td> </tr> <tr> <td>VM2269A0</td> <td>INTERNAL GLASS LOCKING SYSTEM CAP</td> <td>1.000</td> <td>PCS</td> </tr> <tr> <td>VM2274A0</td> <td>DOUILLE RAINUREE COURTE</td> <td>1.000</td> <td>PCS</td> </tr> <tr> <td>VM2305A0</td> <td>DOUILLE DE FIXATION BOUCHON PORTE MM</td> <td>7.000</td> <td>PCS</td> </tr> </tbody> </table>	Code	Description	Qté	UOM	0B1122A1	750MM DOOR LOWER FRAME SHAPE	1.000	PCS	RC1200A0	RESSORT A COMPRESSIO N DE=4 DFIL=0.5	2.000	PCS	V11220A1	VIS AUTOTARADE UX 4.2x12 TCB MARUTEX PRE	1.000	PCS	VI1996A0	VIS M5x35 TCEI ZN	7.000	PCS	VM2259A1	6 SERIES DOOR LOWER LEFT CAP	1.000	PCS	VM2261A1	MM DOOR LOWER RIGHT CAP	1.000	PCS	VM2267A0	GLISSEUR SYSTEME BLOCAGE VITRE INT.	1.000	PCS	VM2269A0	INTERNAL GLASS LOCKING SYSTEM CAP	1.000	PCS	VM2274A0	DOUILLE RAINUREE COURTE	1.000	PCS	VM2305A0	DOUILLE DE FIXATION BOUCHON PORTE MM	7.000	PCS	K0B1122AL	KIT TRAVERS INF PORTE GAUCHE CHEFTOP MM	<table border="1"> <thead> <tr> <th>Code</th> <th>Description</th> <th>Qté</th> <th>UOM</th> </tr> </thead> <tbody> <tr> <td>0B1122A1</td> <td>750MM DOOR LOWER FRAME SHAPE</td> <td>1.000</td> <td>PCS</td> </tr> <tr> <td>RC1200A0</td> <td>RESSORT A COMPRESSIO N DE=4 DFIL=0.5</td> <td>2.000</td> <td>PCS</td> </tr> <tr> <td>V11220A1</td> <td>VIS AUTOTARADE UX 4.2x12 TCB MARUTEX PRE</td> <td>1.000</td> <td>PCS</td> </tr> <tr> <td>VI1996A0</td> <td>VIS M5x35 TCEI ZN</td> <td>7.000</td> <td>PCS</td> </tr> <tr> <td>VM1794A0</td> <td>PLAQUETTE NOIRE 250X4.8 PA66</td> <td>2.000</td> <td>PCS</td> </tr> <tr> <td>VM2103A0</td> <td>PLAQUETTE FERMETURE COLLIER</td> <td>2.000</td> <td>PCS</td> </tr> </tbody> </table>	Code	Description	Qté	UOM	0B1122A1	750MM DOOR LOWER FRAME SHAPE	1.000	PCS	RC1200A0	RESSORT A COMPRESSIO N DE=4 DFIL=0.5	2.000	PCS	V11220A1	VIS AUTOTARADE UX 4.2x12 TCB MARUTEX PRE	1.000	PCS	VI1996A0	VIS M5x35 TCEI ZN	7.000	PCS	VM1794A0	PLAQUETTE NOIRE 250X4.8 PA66	2.000	PCS	VM2103A0	PLAQUETTE FERMETURE COLLIER	2.000	PCS
			Code	Description	Qté	UOM																																																																										
0B1122A1	750MM DOOR LOWER FRAME SHAPE	1.000	PCS																																																																													
RC1200A0	RESSORT A COMPRESSIO N DE=4 DFIL=0.5	2.000	PCS																																																																													
V11220A1	VIS AUTOTARADE UX 4.2x12 TCB MARUTEX PRE	1.000	PCS																																																																													
VI1996A0	VIS M5x35 TCEI ZN	7.000	PCS																																																																													
VM2259A1	6 SERIES DOOR LOWER LEFT CAP	1.000	PCS																																																																													
VM2261A1	MM DOOR LOWER RIGHT CAP	1.000	PCS																																																																													
VM2267A0	GLISSEUR SYSTEME BLOCAGE VITRE INT.	1.000	PCS																																																																													
VM2269A0	INTERNAL GLASS LOCKING SYSTEM CAP	1.000	PCS																																																																													
VM2274A0	DOUILLE RAINUREE COURTE	1.000	PCS																																																																													
VM2305A0	DOUILLE DE FIXATION BOUCHON PORTE MM	7.000	PCS																																																																													
Code	Description	Qté	UOM																																																																													
0B1122A1	750MM DOOR LOWER FRAME SHAPE	1.000	PCS																																																																													
RC1200A0	RESSORT A COMPRESSIO N DE=4 DFIL=0.5	2.000	PCS																																																																													
V11220A1	VIS AUTOTARADE UX 4.2x12 TCB MARUTEX PRE	1.000	PCS																																																																													
VI1996A0	VIS M5x35 TCEI ZN	7.000	PCS																																																																													
VM1794A0	PLAQUETTE NOIRE 250X4.8 PA66	2.000	PCS																																																																													
VM2103A0	PLAQUETTE FERMETURE COLLIER	2.000	PCS																																																																													



COMPOSANT			PIÈCE DE RECHANGE																																						
Code	Description	Image	Code	Description	Composants du kit																																				
VM2259A	6 SERIES DOOR LOWER LEFT CAP		K0B1122AL	KIT TRAVERS INF PORTE GAUCHE CHEFTOP MM	<table border="1"> <thead> <tr> <th>Code</th> <th>Description</th> <th>Qté</th> <th>UOM</th> </tr> </thead> <tbody> <tr> <td>VM2267A0</td> <td>GLISSEUR SYSTEME BLOCAGE VITRE INT.</td> <td>1.000</td> <td>PCS</td> </tr> <tr> <td>VM2269A0</td> <td>INTERNAL GLASS LOCKING SYSTEM CAP</td> <td>1.000</td> <td>PCS</td> </tr> <tr> <td>VM2274A0</td> <td>DOUILLE RAINUREE COURTE</td> <td>1.000</td> <td>PCS</td> </tr> <tr> <td>VM2305A0</td> <td>DOUILLE DE FIXATION BOUCHON PORTE MM</td> <td>7.000</td> <td>PCS</td> </tr> <tr> <td>VM2384A0</td> <td>CAPUCHON INF DROIT PORTE MM GAUCHE</td> <td>1.000</td> <td>PCS</td> </tr> <tr> <td>VM2386A1</td> <td>LEFT MM DOOR LOWER LEFT CAP</td> <td>1.000</td> <td>PCS</td> </tr> </tbody> </table>	Code	Description	Qté	UOM	VM2267A0	GLISSEUR SYSTEME BLOCAGE VITRE INT.	1.000	PCS	VM2269A0	INTERNAL GLASS LOCKING SYSTEM CAP	1.000	PCS	VM2274A0	DOUILLE RAINUREE COURTE	1.000	PCS	VM2305A0	DOUILLE DE FIXATION BOUCHON PORTE MM	7.000	PCS	VM2384A0	CAPUCHON INF DROIT PORTE MM GAUCHE	1.000	PCS	VM2386A1	LEFT MM DOOR LOWER LEFT CAP	1.000	PCS								
Code	Description	Qté	UOM																																						
VM2267A0	GLISSEUR SYSTEME BLOCAGE VITRE INT.	1.000	PCS																																						
VM2269A0	INTERNAL GLASS LOCKING SYSTEM CAP	1.000	PCS																																						
VM2274A0	DOUILLE RAINUREE COURTE	1.000	PCS																																						
VM2305A0	DOUILLE DE FIXATION BOUCHON PORTE MM	7.000	PCS																																						
VM2384A0	CAPUCHON INF DROIT PORTE MM GAUCHE	1.000	PCS																																						
VM2386A1	LEFT MM DOOR LOWER LEFT CAP	1.000	PCS																																						
VM2274A	DOUILLE RAINUREE COURTE		KVM2274A	KIT BUSELURE RAINURE VM2274A0	<table border="1"> <thead> <tr> <th>Code</th> <th>Description</th> <th>Qté</th> <th>UOM</th> </tr> </thead> <tbody> <tr> <td>VM2274A0</td> <td>DOUILLE RAINUREE COURTE</td> <td>1.000</td> <td>PCS</td> </tr> </tbody> </table>	Code	Description	Qté	UOM	VM2274A0	DOUILLE RAINUREE COURTE	1.000	PCS																												
Code	Description	Qté	UOM																																						
VM2274A0	DOUILLE RAINUREE COURTE	1.000	PCS																																						
			K0B1126AR	KIT TRAVERS INF PORTE DROITE BAKERTOP MM	<table border="1"> <thead> <tr> <th>Code</th> <th>Description</th> <th>Qté</th> <th>UOM</th> </tr> </thead> <tbody> <tr> <td>0B1126A1</td> <td>860mm DOOR LOWER FRAME SHAPE</td> <td>1.000</td> <td>PCS</td> </tr> <tr> <td>RC1200A0</td> <td>RESSORT A COMPRESSIO N DE-4 DFIL=0.5</td> <td>2.000</td> <td>PCS</td> </tr> <tr> <td>VI1220A1</td> <td>VIS AUTOTARADE UX 4.2x12 TCB MARUTEX PRE</td> <td>1.000</td> <td>PCS</td> </tr> <tr> <td>VI1996A0</td> <td>VIS M5x35 TCEI ZN</td> <td>7.000</td> <td>PCS</td> </tr> <tr> <td>VM1794A0</td> <td>PLAQUETTE NOIRE 250X4.8 PA66</td> <td>2.000</td> <td>PCS</td> </tr> <tr> <td>VM2103A0</td> <td>PLAQUETTE FERMETURE COLLIER</td> <td>2.000</td> <td>PCS</td> </tr> <tr> <td>VM2259A1</td> <td>6 SERIES DOOR LOWER LEFT CAP</td> <td>1.000</td> <td>PCS</td> </tr> <tr> <td>VM2261A1</td> <td>MM DOOR LOWER RIGHT CAP</td> <td>1.000</td> <td>PCS</td> </tr> </tbody> </table>	Code	Description	Qté	UOM	0B1126A1	860mm DOOR LOWER FRAME SHAPE	1.000	PCS	RC1200A0	RESSORT A COMPRESSIO N DE-4 DFIL=0.5	2.000	PCS	VI1220A1	VIS AUTOTARADE UX 4.2x12 TCB MARUTEX PRE	1.000	PCS	VI1996A0	VIS M5x35 TCEI ZN	7.000	PCS	VM1794A0	PLAQUETTE NOIRE 250X4.8 PA66	2.000	PCS	VM2103A0	PLAQUETTE FERMETURE COLLIER	2.000	PCS	VM2259A1	6 SERIES DOOR LOWER LEFT CAP	1.000	PCS	VM2261A1	MM DOOR LOWER RIGHT CAP	1.000	PCS
Code	Description	Qté	UOM																																						
0B1126A1	860mm DOOR LOWER FRAME SHAPE	1.000	PCS																																						
RC1200A0	RESSORT A COMPRESSIO N DE-4 DFIL=0.5	2.000	PCS																																						
VI1220A1	VIS AUTOTARADE UX 4.2x12 TCB MARUTEX PRE	1.000	PCS																																						
VI1996A0	VIS M5x35 TCEI ZN	7.000	PCS																																						
VM1794A0	PLAQUETTE NOIRE 250X4.8 PA66	2.000	PCS																																						
VM2103A0	PLAQUETTE FERMETURE COLLIER	2.000	PCS																																						
VM2259A1	6 SERIES DOOR LOWER LEFT CAP	1.000	PCS																																						
VM2261A1	MM DOOR LOWER RIGHT CAP	1.000	PCS																																						





COMPOSANT			PIÈCE DE RECHANGE																																																			
Code	Description	Image	Code	Description	Composants du kit																																																	
VM2274A	DOUILLE RAINUREE COURTE		K0B1126AR	KIT TRAVERS INF PORTE DROITE BAKERTOP MM	<table border="1"> <thead> <tr> <th>Code</th> <th>Description</th> <th>Qté</th> <th>UOM</th> </tr> </thead> <tbody> <tr> <td>VM2267A0</td> <td>GLISSEUR SYSTEME BLOCAGE VITRE INT.</td> <td>1.000</td> <td>PCS</td> </tr> <tr> <td>VM2269A0</td> <td>INTERNAL GLASS LOCKING SYSTEM CAP</td> <td>1.000</td> <td>PCS</td> </tr> <tr> <td>VM2274A0</td> <td>DOUILLE RAINUREE COURTE</td> <td>1.000</td> <td>PCS</td> </tr> <tr> <td>VM2305A0</td> <td>DOUILLE DE FIXATION BOUCHON PORTE MM</td> <td>7.000</td> <td>PCS</td> </tr> </tbody> </table>	Code	Description	Qté	UOM	VM2267A0	GLISSEUR SYSTEME BLOCAGE VITRE INT.	1.000	PCS	VM2269A0	INTERNAL GLASS LOCKING SYSTEM CAP	1.000	PCS	VM2274A0	DOUILLE RAINUREE COURTE	1.000	PCS	VM2305A0	DOUILLE DE FIXATION BOUCHON PORTE MM	7.000	PCS																													
			Code	Description	Qté	UOM																																																
VM2267A0	GLISSEUR SYSTEME BLOCAGE VITRE INT.	1.000	PCS																																																			
VM2269A0	INTERNAL GLASS LOCKING SYSTEM CAP	1.000	PCS																																																			
VM2274A0	DOUILLE RAINUREE COURTE	1.000	PCS																																																			
VM2305A0	DOUILLE DE FIXATION BOUCHON PORTE MM	7.000	PCS																																																			
K0B1126AL	KIT TRAVERS INF PORTE GAUCHE EU ET 2/1MM	<table border="1"> <thead> <tr> <th>Code</th> <th>Description</th> <th>Qté</th> <th>UOM</th> </tr> </thead> <tbody> <tr> <td>0B1126A1</td> <td>860mm DOOR LOWER FRAME SHAPE</td> <td>1.000</td> <td>PCS</td> </tr> <tr> <td>RC1200A0</td> <td>RESSORT A COMPRESSIO N DE=4 DFIL=0.5</td> <td>2.000</td> <td>PCS</td> </tr> <tr> <td>VI1220A1</td> <td>VIS AUTOTARADE UX 4.2x12 TCB MARUTEX PRE</td> <td>1.000</td> <td>PCS</td> </tr> <tr> <td>VI1996A0</td> <td>VIS M5x35 TCEI ZN</td> <td>7.000</td> <td>PCS</td> </tr> <tr> <td>VM1794A0</td> <td>PLAQUETTE NOIRE 250X4.8 PA66</td> <td>2.000</td> <td>PCS</td> </tr> <tr> <td>VM2103A0</td> <td>PLAQUETTE FERMETURE COLLIER</td> <td>2.000</td> <td>PCS</td> </tr> <tr> <td>VM2267A0</td> <td>GLISSEUR SYSTEME BLOCAGE VITRE INT.</td> <td>1.000</td> <td>PCS</td> </tr> <tr> <td>VM2269A0</td> <td>INTERNAL GLASS LOCKING SYSTEM CAP</td> <td>1.000</td> <td>PCS</td> </tr> <tr> <td>VM2274A0</td> <td>DOUILLE RAINUREE COURTE</td> <td>1.000</td> <td>PCS</td> </tr> <tr> <td>VM2305A0</td> <td>DOUILLE DE FIXATION BOUCHON PORTE MM</td> <td>7.000</td> <td>PCS</td> </tr> <tr> <td>VM2384A0</td> <td>CAPUCHON INF DROIT PORTE MM GAUCHE</td> <td>1.000</td> <td>PCS</td> </tr> <tr> <td>VM2386A1</td> <td>LEFT MM DOOR LOWER LEFT CAP</td> <td>1.000</td> <td>PCS</td> </tr> </tbody> </table>	Code	Description	Qté	UOM	0B1126A1	860mm DOOR LOWER FRAME SHAPE	1.000	PCS	RC1200A0	RESSORT A COMPRESSIO N DE=4 DFIL=0.5	2.000	PCS	VI1220A1	VIS AUTOTARADE UX 4.2x12 TCB MARUTEX PRE	1.000	PCS	VI1996A0	VIS M5x35 TCEI ZN	7.000	PCS	VM1794A0	PLAQUETTE NOIRE 250X4.8 PA66	2.000	PCS	VM2103A0	PLAQUETTE FERMETURE COLLIER	2.000	PCS	VM2267A0	GLISSEUR SYSTEME BLOCAGE VITRE INT.	1.000	PCS	VM2269A0	INTERNAL GLASS LOCKING SYSTEM CAP	1.000	PCS	VM2274A0	DOUILLE RAINUREE COURTE	1.000	PCS	VM2305A0	DOUILLE DE FIXATION BOUCHON PORTE MM	7.000	PCS	VM2384A0	CAPUCHON INF DROIT PORTE MM GAUCHE	1.000	PCS	VM2386A1	LEFT MM DOOR LOWER LEFT CAP	1.000	PCS
Code	Description	Qté	UOM																																																			
0B1126A1	860mm DOOR LOWER FRAME SHAPE	1.000	PCS																																																			
RC1200A0	RESSORT A COMPRESSIO N DE=4 DFIL=0.5	2.000	PCS																																																			
VI1220A1	VIS AUTOTARADE UX 4.2x12 TCB MARUTEX PRE	1.000	PCS																																																			
VI1996A0	VIS M5x35 TCEI ZN	7.000	PCS																																																			
VM1794A0	PLAQUETTE NOIRE 250X4.8 PA66	2.000	PCS																																																			
VM2103A0	PLAQUETTE FERMETURE COLLIER	2.000	PCS																																																			
VM2267A0	GLISSEUR SYSTEME BLOCAGE VITRE INT.	1.000	PCS																																																			
VM2269A0	INTERNAL GLASS LOCKING SYSTEM CAP	1.000	PCS																																																			
VM2274A0	DOUILLE RAINUREE COURTE	1.000	PCS																																																			
VM2305A0	DOUILLE DE FIXATION BOUCHON PORTE MM	7.000	PCS																																																			
VM2384A0	CAPUCHON INF DROIT PORTE MM GAUCHE	1.000	PCS																																																			
VM2386A1	LEFT MM DOOR LOWER LEFT CAP	1.000	PCS																																																			

COMPOSANT			PIÈCE DE RECHANGE																																																																													
Code	Description	Image	Code	Description	Composants du kit																																																																											
VM2274A	DOUILLE RAINUREE COURTE		K0B1122AR	KIT TRAVERS INF PORTE DROITE CHEFTOP MM	<table border="1"> <thead> <tr> <th>Code</th> <th>Description</th> <th>Qté</th> <th>UOM</th> </tr> </thead> <tbody> <tr> <td>0B1122A1</td> <td>750MM DOOR LOWER FRAME SHAPE</td> <td>1.000</td> <td>PCS</td> </tr> <tr> <td>RC1200A0</td> <td>RESSORT A COMPRESSIO N DE=4 DFIL=0.5</td> <td>2.000</td> <td>PCS</td> </tr> <tr> <td>V11220A1</td> <td>VIS AUTOTARADE UX 4.2x12 TCB MARUTEX PRE</td> <td>1.000</td> <td>PCS</td> </tr> <tr> <td>V11996A0</td> <td>VIS M5x35 TCEI ZN</td> <td>7.000</td> <td>PCS</td> </tr> <tr> <td>VM2259A1</td> <td>6 SERIES DOOR LOWER LEFT CAP</td> <td>1.000</td> <td>PCS</td> </tr> <tr> <td>VM2261A1</td> <td>MM DOOR LOWER RIGHT CAP</td> <td>1.000</td> <td>PCS</td> </tr> <tr> <td>VM2267A0</td> <td>GLISSEUR SYSTEME BLOCAGE VITRE INT.</td> <td>1.000</td> <td>PCS</td> </tr> <tr> <td>VM2269A0</td> <td>INTERNAL GLASS LOCKING SYSTEM CAP</td> <td>1.000</td> <td>PCS</td> </tr> <tr> <td>VM2274A0</td> <td>DOUILLE RAINUREE COURTE</td> <td>1.000</td> <td>PCS</td> </tr> <tr> <td>VM2305A0</td> <td>DOUILLE DE FIXATION BOUCHON PORTE MM</td> <td>7.000</td> <td>PCS</td> </tr> </tbody> </table>	Code	Description	Qté	UOM	0B1122A1	750MM DOOR LOWER FRAME SHAPE	1.000	PCS	RC1200A0	RESSORT A COMPRESSIO N DE=4 DFIL=0.5	2.000	PCS	V11220A1	VIS AUTOTARADE UX 4.2x12 TCB MARUTEX PRE	1.000	PCS	V11996A0	VIS M5x35 TCEI ZN	7.000	PCS	VM2259A1	6 SERIES DOOR LOWER LEFT CAP	1.000	PCS	VM2261A1	MM DOOR LOWER RIGHT CAP	1.000	PCS	VM2267A0	GLISSEUR SYSTEME BLOCAGE VITRE INT.	1.000	PCS	VM2269A0	INTERNAL GLASS LOCKING SYSTEM CAP	1.000	PCS	VM2274A0	DOUILLE RAINUREE COURTE	1.000	PCS	VM2305A0	DOUILLE DE FIXATION BOUCHON PORTE MM	7.000	PCS	K0B1122AL	KIT TRAVERS INF PORTE GAUCHE CHEFTOP MM	<table border="1"> <thead> <tr> <th>Code</th> <th>Description</th> <th>Qté</th> <th>UOM</th> </tr> </thead> <tbody> <tr> <td>0B1122A1</td> <td>750MM DOOR LOWER FRAME SHAPE</td> <td>1.000</td> <td>PCS</td> </tr> <tr> <td>RC1200A0</td> <td>RESSORT A COMPRESSIO N DE=4 DFIL=0.5</td> <td>2.000</td> <td>PCS</td> </tr> <tr> <td>V11220A1</td> <td>VIS AUTOTARADE UX 4.2x12 TCB MARUTEX PRE</td> <td>1.000</td> <td>PCS</td> </tr> <tr> <td>V11996A0</td> <td>VIS M5x35 TCEI ZN</td> <td>7.000</td> <td>PCS</td> </tr> <tr> <td>VM1794A0</td> <td>PLAQUETTE NOIRE 250X4.8 PA66</td> <td>2.000</td> <td>PCS</td> </tr> <tr> <td>VM2103A0</td> <td>PLAQUETTE FERMETURE COLLIER</td> <td>2.000</td> <td>PCS</td> </tr> </tbody> </table>	Code	Description	Qté	UOM	0B1122A1	750MM DOOR LOWER FRAME SHAPE	1.000	PCS	RC1200A0	RESSORT A COMPRESSIO N DE=4 DFIL=0.5	2.000	PCS	V11220A1	VIS AUTOTARADE UX 4.2x12 TCB MARUTEX PRE	1.000	PCS	V11996A0	VIS M5x35 TCEI ZN	7.000	PCS	VM1794A0	PLAQUETTE NOIRE 250X4.8 PA66	2.000	PCS	VM2103A0	PLAQUETTE FERMETURE COLLIER	2.000	PCS
			Code	Description	Qté	UOM																																																																										
0B1122A1	750MM DOOR LOWER FRAME SHAPE	1.000	PCS																																																																													
RC1200A0	RESSORT A COMPRESSIO N DE=4 DFIL=0.5	2.000	PCS																																																																													
V11220A1	VIS AUTOTARADE UX 4.2x12 TCB MARUTEX PRE	1.000	PCS																																																																													
V11996A0	VIS M5x35 TCEI ZN	7.000	PCS																																																																													
VM2259A1	6 SERIES DOOR LOWER LEFT CAP	1.000	PCS																																																																													
VM2261A1	MM DOOR LOWER RIGHT CAP	1.000	PCS																																																																													
VM2267A0	GLISSEUR SYSTEME BLOCAGE VITRE INT.	1.000	PCS																																																																													
VM2269A0	INTERNAL GLASS LOCKING SYSTEM CAP	1.000	PCS																																																																													
VM2274A0	DOUILLE RAINUREE COURTE	1.000	PCS																																																																													
VM2305A0	DOUILLE DE FIXATION BOUCHON PORTE MM	7.000	PCS																																																																													
Code	Description	Qté	UOM																																																																													
0B1122A1	750MM DOOR LOWER FRAME SHAPE	1.000	PCS																																																																													
RC1200A0	RESSORT A COMPRESSIO N DE=4 DFIL=0.5	2.000	PCS																																																																													
V11220A1	VIS AUTOTARADE UX 4.2x12 TCB MARUTEX PRE	1.000	PCS																																																																													
V11996A0	VIS M5x35 TCEI ZN	7.000	PCS																																																																													
VM1794A0	PLAQUETTE NOIRE 250X4.8 PA66	2.000	PCS																																																																													
VM2103A0	PLAQUETTE FERMETURE COLLIER	2.000	PCS																																																																													





COMPOSANT			PIÈCE DE RECHANGE																														
Code	Description	Image	Code	Description	Composants du kit																												
VM2274A	DOUILLE RAINUREE COURTE		K0B1122AL	KIT TRAVERS INF PORTE GAUCHE CHEFTOP MM	<table border="1"> <thead> <tr> <th>Code</th> <th>Description</th> <th>Qté</th> <th>UOM</th> </tr> </thead> <tbody> <tr> <td>VM2267A0</td> <td>GLISSEUR SYSTEME BLOCAGE VITRE INT.</td> <td>1.000</td> <td>PCS</td> </tr> <tr> <td>VM2269A0</td> <td>INTERNAL GLASS LOCKING SYSTEM CAP</td> <td>1.000</td> <td>PCS</td> </tr> <tr> <td>VM2274A0</td> <td>DOUILLE RAINUREE COURTE</td> <td>1.000</td> <td>PCS</td> </tr> <tr> <td>VM2305A0</td> <td>DOUILLE DE FIXATION BOUCHON PORTE MM</td> <td>7.000</td> <td>PCS</td> </tr> <tr> <td>VM2384A0</td> <td>CAPUCHON INF DROIT PORTE MM GAUCHE</td> <td>1.000</td> <td>PCS</td> </tr> <tr> <td>VM2386A1</td> <td>LEFT MM DOOR LOWER LEFT CAP</td> <td>1.000</td> <td>PCS</td> </tr> </tbody> </table>	Code	Description	Qté	UOM	VM2267A0	GLISSEUR SYSTEME BLOCAGE VITRE INT.	1.000	PCS	VM2269A0	INTERNAL GLASS LOCKING SYSTEM CAP	1.000	PCS	VM2274A0	DOUILLE RAINUREE COURTE	1.000	PCS	VM2305A0	DOUILLE DE FIXATION BOUCHON PORTE MM	7.000	PCS	VM2384A0	CAPUCHON INF DROIT PORTE MM GAUCHE	1.000	PCS	VM2386A1	LEFT MM DOOR LOWER LEFT CAP	1.000	PCS
					Code	Description	Qté	UOM																									
					VM2267A0	GLISSEUR SYSTEME BLOCAGE VITRE INT.	1.000	PCS																									
					VM2269A0	INTERNAL GLASS LOCKING SYSTEM CAP	1.000	PCS																									
					VM2274A0	DOUILLE RAINUREE COURTE	1.000	PCS																									
					VM2305A0	DOUILLE DE FIXATION BOUCHON PORTE MM	7.000	PCS																									
VM2384A0	CAPUCHON INF DROIT PORTE MM GAUCHE	1.000	PCS																														
VM2386A1	LEFT MM DOOR LOWER LEFT CAP	1.000	PCS																														
<table border="1"> <thead> <tr> <th>Code</th> <th>Description</th> <th>Qté</th> <th>UOM</th> </tr> </thead> <tbody> <tr> <td>VM2305A0</td> <td>DOUILLE DE FIXATION BOUCHON PORTE M</td> <td>10.000</td> <td>PCS</td> </tr> </tbody> </table>	Code	Description	Qté	UOM	VM2305A0	DOUILLE DE FIXATION BOUCHON PORTE M	10.000	PCS																									
Code	Description	Qté	UOM																														
VM2305A0	DOUILLE DE FIXATION BOUCHON PORTE M	10.000	PCS																														
<table border="1"> <thead> <tr> <th>Code</th> <th>Description</th> <th>Qté</th> <th>UOM</th> </tr> </thead> <tbody> <tr> <td>VM2284A0</td> <td>750 SERIES DRIP PROFILE</td> <td>1.000</td> <td>PCS</td> </tr> </tbody> </table>	Code	Description	Qté	UOM	VM2284A0	750 SERIES DRIP PROFILE	1.000	PCS																									
Code	Description	Qté	UOM																														
VM2284A0	750 SERIES DRIP PROFILE	1.000	PCS																														
<table border="1"> <thead> <tr> <th>Code</th> <th>Description</th> <th>Qté</th> <th>UOM</th> </tr> </thead> <tbody> <tr> <td>V11220A1</td> <td>VIS AUTOTARADE UX 4.2x12 TCB MARUTEX PRE</td> <td>1.000</td> <td>PCS</td> </tr> <tr> <td>VM2312A0</td> <td>TUBE GAUCHE DECHARGE EGOUTTEMEN T MM</td> <td>1.000</td> <td>PCS</td> </tr> </tbody> </table>	Code	Description	Qté	UOM	V11220A1	VIS AUTOTARADE UX 4.2x12 TCB MARUTEX PRE	1.000	PCS	VM2312A0	TUBE GAUCHE DECHARGE EGOUTTEMEN T MM	1.000	PCS																					
Code	Description	Qté	UOM																														
V11220A1	VIS AUTOTARADE UX 4.2x12 TCB MARUTEX PRE	1.000	PCS																														
VM2312A0	TUBE GAUCHE DECHARGE EGOUTTEMEN T MM	1.000	PCS																														
<table border="1"> <thead> <tr> <th>Code</th> <th>Description</th> <th>Qté</th> <th>UOM</th> </tr> </thead> <tbody> <tr> <td>KVM2305A</td> <td>KIT 10 LOQUETS FIXATION PORTE M</td> <td></td> <td></td> </tr> </tbody> </table>	Code	Description	Qté	UOM	KVM2305A	KIT 10 LOQUETS FIXATION PORTE M																											
Code	Description	Qté	UOM																														
KVM2305A	KIT 10 LOQUETS FIXATION PORTE M																																
<table border="1"> <thead> <tr> <th>Code</th> <th>Description</th> <th>Qté</th> <th>UOM</th> </tr> </thead> <tbody> <tr> <td>KVM2284A</td> <td>KIT PROFIL PROTEGE-GOUTTE SERIE 750</td> <td></td> <td></td> </tr> </tbody> </table>	Code	Description	Qté	UOM	KVM2284A	KIT PROFIL PROTEGE-GOUTTE SERIE 750																											
Code	Description	Qté	UOM																														
KVM2284A	KIT PROFIL PROTEGE-GOUTTE SERIE 750																																
VM2312A	TUBE GAUCHE DECHARGE EGOUTTEMENT MM		KVM2312A	KIT TUBE GAUCHE EVACUATION GOUTIER																													

COMPOSANT			PIÈCE DE RECHANGE																		
Code	Description	Image	Code	Description	Composants du kit																
VM2314A	MM DRIP PROFILE CAP		KVM2314A	KIT BOUCHON EGOUTTOIR MOND MAPS	<table border="1"> <thead> <tr> <th>Code</th> <th>Description</th> <th>Qté</th> <th>UOM</th> </tr> </thead> <tbody> <tr> <td>GN1525A0</td> <td>O-RING INT DIAM 9,5 THK 1 NBR 70</td> <td>1.000</td> <td>PCS</td> </tr> <tr> <td>VI1103A0</td> <td>VIS POUR PLASTIQUE 40X12 TPBS+INOX</td> <td>1.000</td> <td>PCS</td> </tr> <tr> <td>VM2314A0</td> <td>MM DRIP PROFILE CAP</td> <td>1.000</td> <td>PCS</td> </tr> </tbody> </table>	Code	Description	Qté	UOM	GN1525A0	O-RING INT DIAM 9,5 THK 1 NBR 70	1.000	PCS	VI1103A0	VIS POUR PLASTIQUE 40X12 TPBS+INOX	1.000	PCS	VM2314A0	MM DRIP PROFILE CAP	1.000	PCS
Code	Description	Qté	UOM																		
GN1525A0	O-RING INT DIAM 9,5 THK 1 NBR 70	1.000	PCS																		
VI1103A0	VIS POUR PLASTIQUE 40X12 TPBS+INOX	1.000	PCS																		
VM2314A0	MM DRIP PROFILE CAP	1.000	PCS																		
VM2371A	DOUBLE GLASS DOOR PUSHING BRACKET		KVM2505A	KIT 3PCS POUSSE-VITRE PORTE DOUBLE VITRE	<table border="1"> <thead> <tr> <th>Code</th> <th>Description</th> <th>Qté</th> <th>UOM</th> </tr> </thead> <tbody> <tr> <td>VI1220A1</td> <td>VIS AUTOTARADE UX 4.2x12 TCB MARUTEX PRE</td> <td>3.000</td> <td>PCS</td> </tr> <tr> <td>VM1631A0</td> <td>BOUCHON POUSSE-VITR E INTERNE PLUS</td> <td>3.000</td> <td>PCS</td> </tr> <tr> <td>VM2505A0</td> <td>MM PLUS INTERNAL GLASS SUPPORT</td> <td>3.000</td> <td>PCS</td> </tr> </tbody> </table>	Code	Description	Qté	UOM	VI1220A1	VIS AUTOTARADE UX 4.2x12 TCB MARUTEX PRE	3.000	PCS	VM1631A0	BOUCHON POUSSE-VITR E INTERNE PLUS	3.000	PCS	VM2505A0	MM PLUS INTERNAL GLASS SUPPORT	3.000	PCS
Code	Description	Qté	UOM																		
VI1220A1	VIS AUTOTARADE UX 4.2x12 TCB MARUTEX PRE	3.000	PCS																		
VM1631A0	BOUCHON POUSSE-VITR E INTERNE PLUS	3.000	PCS																		
VM2505A0	MM PLUS INTERNAL GLASS SUPPORT	3.000	PCS																		
CR1105A	CHARNIERE DOUBLE VITRE INT INOX SUP		KCR1105A	KIT CHARNIERES VITRE INT MIND.Maps PLUS	<table border="1"> <thead> <tr> <th>Code</th> <th>Description</th> <th>Qté</th> <th>UOM</th> </tr> </thead> <tbody> <tr> <td>CR1105A0</td> <td>CHARNIERE DOUBLE VITRE INT INOX SUP</td> <td>1.000</td> <td>PCS</td> </tr> <tr> <td>CR1106A0</td> <td>CHARNIERE DOUBLE VITRE INT INOX INF</td> <td>1.000</td> <td>PCS</td> </tr> <tr> <td>VI1220A1</td> <td>VIS AUTOTARADE UX 4.2x12 TCB MARUTEX PRE</td> <td>4.000</td> <td>PCS</td> </tr> </tbody> </table>	Code	Description	Qté	UOM	CR1105A0	CHARNIERE DOUBLE VITRE INT INOX SUP	1.000	PCS	CR1106A0	CHARNIERE DOUBLE VITRE INT INOX INF	1.000	PCS	VI1220A1	VIS AUTOTARADE UX 4.2x12 TCB MARUTEX PRE	4.000	PCS
Code	Description	Qté	UOM																		
CR1105A0	CHARNIERE DOUBLE VITRE INT INOX SUP	1.000	PCS																		
CR1106A0	CHARNIERE DOUBLE VITRE INT INOX INF	1.000	PCS																		
VI1220A1	VIS AUTOTARADE UX 4.2x12 TCB MARUTEX PRE	4.000	PCS																		
CR1106A	CHARNIERE DOUBLE VITRE INT INOX INF		KCR1105A	KIT CHARNIERES VITRE INT MIND.Maps PLUS	<table border="1"> <thead> <tr> <th>Code</th> <th>Description</th> <th>Qté</th> <th>UOM</th> </tr> </thead> <tbody> <tr> <td>CR1105A0</td> <td>CHARNIERE DOUBLE VITRE INT INOX SUP</td> <td>1.000</td> <td>PCS</td> </tr> <tr> <td>CR1106A0</td> <td>CHARNIERE DOUBLE VITRE INT INOX INF</td> <td>1.000</td> <td>PCS</td> </tr> <tr> <td>VI1220A1</td> <td>VIS AUTOTARADE UX 4.2x12 TCB MARUTEX PRE</td> <td>4.000</td> <td>PCS</td> </tr> </tbody> </table>	Code	Description	Qté	UOM	CR1105A0	CHARNIERE DOUBLE VITRE INT INOX SUP	1.000	PCS	CR1106A0	CHARNIERE DOUBLE VITRE INT INOX INF	1.000	PCS	VI1220A1	VIS AUTOTARADE UX 4.2x12 TCB MARUTEX PRE	4.000	PCS
Code	Description	Qté	UOM																		
CR1105A0	CHARNIERE DOUBLE VITRE INT INOX SUP	1.000	PCS																		
CR1106A0	CHARNIERE DOUBLE VITRE INT INOX INF	1.000	PCS																		
VI1220A1	VIS AUTOTARADE UX 4.2x12 TCB MARUTEX PRE	4.000	PCS																		



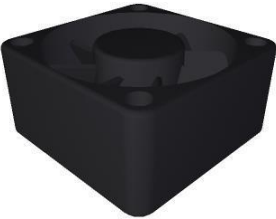

COMPOSANT			PIÈCE DE RECHANGE																																										
Code	Description	Image	Code	Description	Composants du kit																																								
VT1285A	DOUBLE VITRE INT. SER. 0711 639x622x4		KVT1285B	KIT VITRE INTERNE 0711 2V	<table border="1"> <thead> <tr> <th>Code</th> <th>Description</th> <th>Qté</th> <th>UOM</th> </tr> </thead> <tbody> <tr> <td>0B1180A0</td> <td>PROFIL INT SUP INF DOUBLE VITRE GN11</td> <td>2.000</td> <td>PCS</td> </tr> <tr> <td>0B1182A0</td> <td>PROFIL INT GAUCHE DROIT DOUBLE VITRE 071</td> <td>2.000</td> <td>PCS</td> </tr> <tr> <td>0B1210A1</td> <td>PROFIL EXT SUP INF DOUBLE VITRE GN11</td> <td>2.000</td> <td>PCS</td> </tr> <tr> <td>0B1213A3</td> <td>PROFIL EXT GAUCHE DROIT DOUBLE VITRE 071</td> <td>2.000</td> <td>PCS</td> </tr> <tr> <td>CR1105A0</td> <td>CHARNIERE DOUBLE VITRE INT INOX SUP</td> <td>1.000</td> <td>PCS</td> </tr> <tr> <td>CR1106A0</td> <td>CHARNIERE DOUBLE VITRE INT INOX INF</td> <td>1.000</td> <td>PCS</td> </tr> <tr> <td>VI1220A1</td> <td>VIS AUTOTARADE UX 4.2x12 TCB MARUTEX PRE</td> <td>4.000</td> <td>PCS</td> </tr> <tr> <td>VI1225A0</td> <td>RIVET STRUCT 4X8 INOX</td> <td>20.000</td> <td>PCS</td> </tr> <tr> <td>VT1285B0</td> <td>DOUBLE VITRE INT SER 0711 639X622X</td> <td>2.000</td> <td>PCS</td> </tr> </tbody> </table>	Code	Description	Qté	UOM	0B1180A0	PROFIL INT SUP INF DOUBLE VITRE GN11	2.000	PCS	0B1182A0	PROFIL INT GAUCHE DROIT DOUBLE VITRE 071	2.000	PCS	0B1210A1	PROFIL EXT SUP INF DOUBLE VITRE GN11	2.000	PCS	0B1213A3	PROFIL EXT GAUCHE DROIT DOUBLE VITRE 071	2.000	PCS	CR1105A0	CHARNIERE DOUBLE VITRE INT INOX SUP	1.000	PCS	CR1106A0	CHARNIERE DOUBLE VITRE INT INOX INF	1.000	PCS	VI1220A1	VIS AUTOTARADE UX 4.2x12 TCB MARUTEX PRE	4.000	PCS	VI1225A0	RIVET STRUCT 4X8 INOX	20.000	PCS	VT1285B0	DOUBLE VITRE INT SER 0711 639X622X	2.000	PCS
					Code	Description	Qté	UOM																																					
					0B1180A0	PROFIL INT SUP INF DOUBLE VITRE GN11	2.000	PCS																																					
					0B1182A0	PROFIL INT GAUCHE DROIT DOUBLE VITRE 071	2.000	PCS																																					
					0B1210A1	PROFIL EXT SUP INF DOUBLE VITRE GN11	2.000	PCS																																					
					0B1213A3	PROFIL EXT GAUCHE DROIT DOUBLE VITRE 071	2.000	PCS																																					
					CR1105A0	CHARNIERE DOUBLE VITRE INT INOX SUP	1.000	PCS																																					
					CR1106A0	CHARNIERE DOUBLE VITRE INT INOX INF	1.000	PCS																																					
					VI1220A1	VIS AUTOTARADE UX 4.2x12 TCB MARUTEX PRE	4.000	PCS																																					
					VI1225A0	RIVET STRUCT 4X8 INOX	20.000	PCS																																					
VT1285B0	DOUBLE VITRE INT SER 0711 639X622X	2.000	PCS																																										
VM2518A	SUPP VENTILAT REFROID CONTROLE 20X20 H20		KVM2518A	KIT SUPP VENTIL REFROID PANNEAU CONTROLE	<table border="1"> <thead> <tr> <th>Code</th> <th>Description</th> <th>Qté</th> <th>UOM</th> </tr> </thead> <tbody> <tr> <td>VM2518A0</td> <td>SUPP VENTILAT REFROID CONTROLE 20X20 H20</td> <td>1.000</td> <td>PCS</td> </tr> </tbody> </table>	Code	Description	Qté	UOM	VM2518A0	SUPP VENTILAT REFROID CONTROLE 20X20 H20	1.000	PCS																																
Code	Description	Qté	UOM																																										
VM2518A0	SUPP VENTILAT REFROID CONTROLE 20X20 H20	1.000	PCS																																										



COMPOSANT			PIÈCE DE RECHANGE										
Code	Description	Image	Code	Description	Composants du kit								
VN1179A	VENTILO AXIAL 40X40X20MM 12VCD		KVN1179A	KIT VENTILATEUR AXIAL 40x40x20mm 12Vcc	<table border="1"> <thead> <tr> <th>Code</th> <th>Description</th> <th>Qté</th> <th>UOM</th> </tr> </thead> <tbody> <tr> <td>VN1179A1</td> <td>VENTILO AXIAL 40X40X20MM 12VCD</td> <td>1.000</td> <td>PCS</td> </tr> </tbody> </table>	Code	Description	Qté	UOM	VN1179A1	VENTILO AXIAL 40X40X20MM 12VCD	1.000	PCS
Code	Description	Qté	UOM										
VN1179A1	VENTILO AXIAL 40X40X20MM 12VCD	1.000	PCS										
CE1052A	CABLE DE LIAISON CONTROLE-USB MM 750MM		KCE1052A	KIT CABLE CONN CONTROLE-USB MM 650	<table border="1"> <thead> <tr> <th>Code</th> <th>Description</th> <th>Qté</th> <th>UOM</th> </tr> </thead> <tbody> <tr> <td>CE1052A1</td> <td>CABLE DE LIAISON CONTROLE-U SB MM 750MM</td> <td>1.000</td> <td>PCS</td> </tr> </tbody> </table>	Code	Description	Qté	UOM	CE1052A1	CABLE DE LIAISON CONTROLE-U SB MM 750MM	1.000	PCS
Code	Description	Qté	UOM										
CE1052A1	CABLE DE LIAISON CONTROLE-U SB MM 750MM	1.000	PCS										
CE1053B	CABLE ALIM BARRE LED MM MICROFIT 2		KCE1053B	KIT CABLE RALLONGE BARRE LED	<table border="1"> <thead> <tr> <th>Code</th> <th>Description</th> <th>Qté</th> <th>UOM</th> </tr> </thead> <tbody> <tr> <td>CE1053B0</td> <td>CABLE ALIM BARRE LED MM MICROFIT 2P</td> <td>1.000</td> <td>PCS</td> </tr> </tbody> </table>	Code	Description	Qté	UOM	CE1053B0	CABLE ALIM BARRE LED MM MICROFIT 2P	1.000	PCS
Code	Description	Qté	UOM										
CE1053B0	CABLE ALIM BARRE LED MM MICROFIT 2P	1.000	PCS										
LP1020A	BARRE ECLAIRAGE LED MM L400 E583		KLP1020A	KIT BARRE LED MM L400 E583	<table border="1"> <thead> <tr> <th>Code</th> <th>Description</th> <th>Qté</th> <th>UOM</th> </tr> </thead> <tbody> <tr> <td>LP1020A0</td> <td>BARRE ECLAIRAGE LED MM L400 E583</td> <td>1.000</td> <td>PCS</td> </tr> </tbody> </table>	Code	Description	Qté	UOM	LP1020A0	BARRE ECLAIRAGE LED MM L400 E583	1.000	PCS
Code	Description	Qté	UOM										
LP1020A0	BARRE ECLAIRAGE LED MM L400 E583	1.000	PCS										
LP1026A	EXTRUDE ECLAIRAGE NON LED MM L583		KLP1026A	KIT BARRE ECLAIRAGE NO LED MM L583	<table border="1"> <thead> <tr> <th>Code</th> <th>Description</th> <th>Qté</th> <th>UOM</th> </tr> </thead> <tbody> <tr> <td>LP1026A0</td> <td>EXTRUDE ECLAIRAGE NON LED MM L583</td> <td>1.000</td> <td>PCS</td> </tr> </tbody> </table>	Code	Description	Qté	UOM	LP1026A0	EXTRUDE ECLAIRAGE NON LED MM L583	1.000	PCS
Code	Description	Qté	UOM										
LP1026A0	EXTRUDE ECLAIRAGE NON LED MM L583	1.000	PCS										

COMPOSANT			PIÈCE DE RECHANGE																										
Code	Description	Image	Code	Description	Composants du kit																								
MG1083A	ENSEMBLE POIGNEE COMPLET MM		KMG1083A	KIT POIGNEE COMPLET MIND.Map	<table border="1"> <thead> <tr> <th>Code</th> <th>Description</th> <th>Qté</th> <th>UOM</th> </tr> </thead> <tbody> <tr> <td>MG1083A2</td> <td>POIGNEE COMPLETE M</td> <td>1.000</td> <td>PCS</td> </tr> <tr> <td>VI0239A1</td> <td>VIS AUTOPERCEU SE 4.2X25 TCB+INOX</td> <td>4.000</td> <td>PCS</td> </tr> <tr> <td>VM1490A0</td> <td>COUVERTURE VIS POIGNEE CT BT</td> <td>2.000</td> <td>PCS</td> </tr> </tbody> </table>	Code	Description	Qté	UOM	MG1083A2	POIGNEE COMPLETE M	1.000	PCS	VI0239A1	VIS AUTOPERCEU SE 4.2X25 TCB+INOX	4.000	PCS	VM1490A0	COUVERTURE VIS POIGNEE CT BT	2.000	PCS								
					Code	Description	Qté	UOM																					
MG1083A2	POIGNEE COMPLETE M	1.000	PCS																										
VI0239A1	VIS AUTOPERCEU SE 4.2X25 TCB+INOX	4.000	PCS																										
VM1490A0	COUVERTURE VIS POIGNEE CT BT	2.000	PCS																										
<table border="1"> <thead> <tr> <th>Code</th> <th>Description</th> <th>Qté</th> <th>UOM</th> </tr> </thead> <tbody> <tr> <td>CE2007A0</td> <td>CABLE MICROFIT 4 PM-MINIFIT 4 PF 100MM</td> <td>1.000</td> <td>PCS</td> </tr> <tr> <td>PE1057B0</td> <td>PANNEAU CONTROLE COMPLET CAP MM PLUS</td> <td>1.000</td> <td>PCS</td> </tr> <tr> <td>VI1074A0</td> <td>VIS POUR PLASTIQUE 4X16 TCB+INO</td> <td>2.000</td> <td>PCS</td> </tr> <tr> <td>VM2295A1</td> <td>STYLO CONTROLE M</td> <td>1.000</td> <td>PCS</td> </tr> <tr> <td>VP1067A0</td> <td>ENTRETOISE RETROFIT POUR CONTROLE M</td> <td>1.000</td> <td>PCS</td> </tr> <tr> <td>VP1078A0</td> <td>CADRE ADAPTATION PANNEAU DE CONTROLE M</td> <td>1.000</td> <td>PCS</td> </tr> </tbody> </table>	Code	Description	Qté	UOM	CE2007A0	CABLE MICROFIT 4 PM-MINIFIT 4 PF 100MM	1.000	PCS	PE1057B0	PANNEAU CONTROLE COMPLET CAP MM PLUS	1.000	PCS	VI1074A0	VIS POUR PLASTIQUE 4X16 TCB+INO	2.000	PCS	VM2295A1	STYLO CONTROLE M	1.000	PCS	VP1067A0	ENTRETOISE RETROFIT POUR CONTROLE M	1.000	PCS	VP1078A0	CADRE ADAPTATION PANNEAU DE CONTROLE M	1.000	PCS	
Code	Description	Qté	UOM																										
CE2007A0	CABLE MICROFIT 4 PM-MINIFIT 4 PF 100MM	1.000	PCS																										
PE1057B0	PANNEAU CONTROLE COMPLET CAP MM PLUS	1.000	PCS																										
VI1074A0	VIS POUR PLASTIQUE 4X16 TCB+INO	2.000	PCS																										
VM2295A1	STYLO CONTROLE M	1.000	PCS																										
VP1067A0	ENTRETOISE RETROFIT POUR CONTROLE M	1.000	PCS																										
VP1078A0	CADRE ADAPTATION PANNEAU DE CONTROLE M	1.000	PCS																										
PE2044A	MM PLUS VERSION CONTROL BOARD		KPE1057A	KIT TABLEAU DE BORD CAPACITATIF MM PLUS	<table border="1"> <thead> <tr> <th>Code</th> <th>Description</th> <th>Qté</th> <th>UOM</th> </tr> </thead> <tbody> <tr> <td>PE1057B0</td> <td>PANNEAU CONTROLE COMPLET CAP MM PLUS</td> <td>1.000</td> <td>PCS</td> </tr> <tr> <td>VI1074A0</td> <td>VIS POUR PLASTIQUE 4X16 TCB+INO</td> <td>2.000</td> <td>PCS</td> </tr> <tr> <td>VM2295A1</td> <td>STYLO CONTROLE M</td> <td>1.000</td> <td>PCS</td> </tr> <tr> <td>VP1067A0</td> <td>ENTRETOISE RETROFIT POUR CONTROLE M</td> <td>1.000</td> <td>PCS</td> </tr> <tr> <td>VP1078A0</td> <td>CADRE ADAPTATION PANNEAU DE CONTROLE M</td> <td>1.000</td> <td>PCS</td> </tr> </tbody> </table>	Code	Description	Qté	UOM	PE1057B0	PANNEAU CONTROLE COMPLET CAP MM PLUS	1.000	PCS	VI1074A0	VIS POUR PLASTIQUE 4X16 TCB+INO	2.000	PCS	VM2295A1	STYLO CONTROLE M	1.000	PCS	VP1067A0	ENTRETOISE RETROFIT POUR CONTROLE M	1.000	PCS	VP1078A0	CADRE ADAPTATION PANNEAU DE CONTROLE M	1.000	PCS
					Code	Description	Qté	UOM																					
PE1057B0	PANNEAU CONTROLE COMPLET CAP MM PLUS	1.000	PCS																										
VI1074A0	VIS POUR PLASTIQUE 4X16 TCB+INO	2.000	PCS																										
VM2295A1	STYLO CONTROLE M	1.000	PCS																										
VP1067A0	ENTRETOISE RETROFIT POUR CONTROLE M	1.000	PCS																										
VP1078A0	CADRE ADAPTATION PANNEAU DE CONTROLE M	1.000	PCS																										
<table border="1"> <thead> <tr> <th>Code</th> <th>Description</th> <th>Qté</th> <th>UOM</th> </tr> </thead> <tbody> <tr> <td>PE1057B0</td> <td>PANNEAU CONTROLE COMPLET CAP MM PLUS</td> <td>1.000</td> <td>PCS</td> </tr> <tr> <td>VI1074A0</td> <td>VIS POUR PLASTIQUE 4X16 TCB+INO</td> <td>2.000</td> <td>PCS</td> </tr> <tr> <td>VM2295A1</td> <td>STYLO CONTROLE M</td> <td>1.000</td> <td>PCS</td> </tr> <tr> <td>VP1067A0</td> <td>ENTRETOISE RETROFIT POUR CONTROLE M</td> <td>1.000</td> <td>PCS</td> </tr> <tr> <td>VP1078A0</td> <td>CADRE ADAPTATION PANNEAU DE CONTROLE M</td> <td>1.000</td> <td>PCS</td> </tr> </tbody> </table>	Code	Description	Qté	UOM	PE1057B0	PANNEAU CONTROLE COMPLET CAP MM PLUS	1.000	PCS	VI1074A0	VIS POUR PLASTIQUE 4X16 TCB+INO	2.000	PCS	VM2295A1	STYLO CONTROLE M	1.000	PCS	VP1067A0	ENTRETOISE RETROFIT POUR CONTROLE M	1.000	PCS	VP1078A0	CADRE ADAPTATION PANNEAU DE CONTROLE M	1.000	PCS					
Code	Description	Qté	UOM																										
PE1057B0	PANNEAU CONTROLE COMPLET CAP MM PLUS	1.000	PCS																										
VI1074A0	VIS POUR PLASTIQUE 4X16 TCB+INO	2.000	PCS																										
VM2295A1	STYLO CONTROLE M	1.000	PCS																										
VP1067A0	ENTRETOISE RETROFIT POUR CONTROLE M	1.000	PCS																										
VP1078A0	CADRE ADAPTATION PANNEAU DE CONTROLE M	1.000	PCS																										
PE2046A	ENSEMBLE SUPPORT USB-RESET MM		KPE1059A	KIT ENSEMBLE SUPPORT USB-RESET MM	<table border="1"> <thead> <tr> <th>Code</th> <th>Description</th> <th>Qté</th> <th>UOM</th> </tr> </thead> <tbody> <tr> <td>PE1059A0</td> <td>ENSEMBLE SUPPORT USB-RESET M</td> <td>1.000</td> <td>PCS</td> </tr> <tr> <td>VI1220A1</td> <td>VIS AUTOTARADE UX 4.2x12 TCB MARUTEX PRE</td> <td>2.000</td> <td>PCS</td> </tr> </tbody> </table>	Code	Description	Qté	UOM	PE1059A0	ENSEMBLE SUPPORT USB-RESET M	1.000	PCS	VI1220A1	VIS AUTOTARADE UX 4.2x12 TCB MARUTEX PRE	2.000	PCS												
					Code	Description	Qté	UOM																					
PE1059A0	ENSEMBLE SUPPORT USB-RESET M	1.000	PCS																										
VI1220A1	VIS AUTOTARADE UX 4.2x12 TCB MARUTEX PRE	2.000	PCS																										
<table border="1"> <thead> <tr> <th>Code</th> <th>Description</th> <th>Qté</th> <th>UOM</th> </tr> </thead> <tbody> <tr> <td>PE1059A0</td> <td>ENSEMBLE SUPPORT USB-RESET M</td> <td>1.000</td> <td>PCS</td> </tr> <tr> <td>VI1220A1</td> <td>VIS AUTOTARADE UX 4.2x12 TCB MARUTEX PRE</td> <td>2.000</td> <td>PCS</td> </tr> </tbody> </table>	Code	Description	Qté	UOM	PE1059A0	ENSEMBLE SUPPORT USB-RESET M	1.000	PCS	VI1220A1	VIS AUTOTARADE UX 4.2x12 TCB MARUTEX PRE	2.000	PCS																	
Code	Description	Qté	UOM																										
PE1059A0	ENSEMBLE SUPPORT USB-RESET M	1.000	PCS																										
VI1220A1	VIS AUTOTARADE UX 4.2x12 TCB MARUTEX PRE	2.000	PCS																										
VI1034A	STAINLESS STEEL WASHER 8.4x16x1		KVI1034A	KIT 10 PCS RONDELLE PLATE INOX	<table border="1"> <thead> <tr> <th>Code</th> <th>Description</th> <th>Qté</th> <th>UOM</th> </tr> </thead> <tbody> <tr> <td>VI1034A0</td> <td>STAINLESS STEEL WASHER 8.4x16x1</td> <td>10.000</td> <td>PCS</td> </tr> </tbody> </table>	Code	Description	Qté	UOM	VI1034A0	STAINLESS STEEL WASHER 8.4x16x1	10.000	PCS																
					Code	Description	Qté	UOM																					
VI1034A0	STAINLESS STEEL WASHER 8.4x16x1	10.000	PCS																										
<table border="1"> <thead> <tr> <th>Code</th> <th>Description</th> <th>Qté</th> <th>UOM</th> </tr> </thead> <tbody> <tr> <td>VI1034A0</td> <td>STAINLESS STEEL WASHER 8.4x16x1</td> <td>10.000</td> <td>PCS</td> </tr> </tbody> </table>	Code	Description	Qté	UOM	VI1034A0	STAINLESS STEEL WASHER 8.4x16x1	10.000	PCS																					
Code	Description	Qté	UOM																										
VI1034A0	STAINLESS STEEL WASHER 8.4x16x1	10.000	PCS																										

COMPOSANT			PIÈCE DE RECHANGE																														
Code	Description	Image	Code	Description	Composants du kit																												
VM2410A	PLAQUETTE ARRET EXTRUDE BARRE LE		KVM2410A	KIT PLAQUETTE ARRET BARRE LED 2P	<table border="1"> <thead> <tr> <th>Code</th> <th>Description</th> <th>Qté</th> <th>UOM</th> </tr> </thead> <tbody> <tr> <td>0B1190A0</td> <td>PLATE TO STOP EXTRUDED LED BAR</td> <td>2.000</td> <td>PCS</td> </tr> <tr> <td>VM2410A0</td> <td>PLAQUETTE ARRET EXTRUDE BARRE LED</td> <td>2.000</td> <td>PCS</td> </tr> </tbody> </table>	Code	Description	Qté	UOM	0B1190A0	PLATE TO STOP EXTRUDED LED BAR	2.000	PCS	VM2410A0	PLAQUETTE ARRET EXTRUDE BARRE LED	2.000	PCS																
Code	Description	Qté	UOM																														
0B1190A0	PLATE TO STOP EXTRUDED LED BAR	2.000	PCS																														
VM2410A0	PLAQUETTE ARRET EXTRUDE BARRE LED	2.000	PCS																														
VT1277A	VITRE EXT SER XEVC-0711-E		KVT1277A	KIT VITRE EXTERNE 0711	<table border="1"> <thead> <tr> <th>Code</th> <th>Description</th> <th>Qté</th> <th>UOM</th> </tr> </thead> <tbody> <tr> <td>0B1167A0</td> <td>PROFIL SUPPORT VITRE EXT XEVC-0711-E</td> <td>2.000</td> <td>PCS</td> </tr> <tr> <td>SL1221A0</td> <td>GN1/1 EXTERNAL GLASS UPPER SILICONE</td> <td>1.000</td> <td>PCS</td> </tr> <tr> <td>SL1224A0</td> <td>0711 EXTERNAL GLASS LATERAL SILICONE</td> <td>4.000</td> <td>PCS</td> </tr> <tr> <td>VT1277A0</td> <td>VITRE EXT SER XEVC-0711-E</td> <td>1.000</td> <td>PCS</td> </tr> </tbody> </table>	Code	Description	Qté	UOM	0B1167A0	PROFIL SUPPORT VITRE EXT XEVC-0711-E	2.000	PCS	SL1221A0	GN1/1 EXTERNAL GLASS UPPER SILICONE	1.000	PCS	SL1224A0	0711 EXTERNAL GLASS LATERAL SILICONE	4.000	PCS	VT1277A0	VITRE EXT SER XEVC-0711-E	1.000	PCS								
Code	Description	Qté	UOM																														
0B1167A0	PROFIL SUPPORT VITRE EXT XEVC-0711-E	2.000	PCS																														
SL1221A0	GN1/1 EXTERNAL GLASS UPPER SILICONE	1.000	PCS																														
SL1224A0	0711 EXTERNAL GLASS LATERAL SILICONE	4.000	PCS																														
VT1277A0	VITRE EXT SER XEVC-0711-E	1.000	PCS																														
			KDR1328A	PORTE EXTERNE 0711 ZERO GAUCHE -M	<table border="1"> <thead> <tr> <th>Code</th> <th>Description</th> <th>Qté</th> <th>UOM</th> </tr> </thead> <tbody> <tr> <td>0B1122B0</td> <td>MM CT 750mm DOOR LOWER BEAM</td> <td>1.000</td> <td>PCS</td> </tr> <tr> <td>0B1167A0</td> <td>PROFIL SUPPORT VITRE EXT XEVC-0711-E</td> <td>2.000</td> <td>PCS</td> </tr> <tr> <td>0B1198B1</td> <td>LEFT 0711-06FS/EU/ 21 DOOR LT EXT COLUMN</td> <td>1.000</td> <td>PCS</td> </tr> <tr> <td>0B1199A2</td> <td>LEFT 0711-06FS/EU/ 21 DOOR RT INT COLUMN</td> <td>1.000</td> <td>PCS</td> </tr> <tr> <td>0B1200A2</td> <td>LEFT 0711-06FS/EU/ 21 DOOR LT INT COLUMN</td> <td>1.000</td> <td>PCS</td> </tr> <tr> <td>0B1207A0</td> <td>LEFT 0711-06FS/EU/ 21 DOOR RT EXT COLUMN</td> <td>1.000</td> <td>PCS</td> </tr> </tbody> </table>	Code	Description	Qté	UOM	0B1122B0	MM CT 750mm DOOR LOWER BEAM	1.000	PCS	0B1167A0	PROFIL SUPPORT VITRE EXT XEVC-0711-E	2.000	PCS	0B1198B1	LEFT 0711-06FS/EU/ 21 DOOR LT EXT COLUMN	1.000	PCS	0B1199A2	LEFT 0711-06FS/EU/ 21 DOOR RT INT COLUMN	1.000	PCS	0B1200A2	LEFT 0711-06FS/EU/ 21 DOOR LT INT COLUMN	1.000	PCS	0B1207A0	LEFT 0711-06FS/EU/ 21 DOOR RT EXT COLUMN	1.000	PCS
Code	Description	Qté	UOM																														
0B1122B0	MM CT 750mm DOOR LOWER BEAM	1.000	PCS																														
0B1167A0	PROFIL SUPPORT VITRE EXT XEVC-0711-E	2.000	PCS																														
0B1198B1	LEFT 0711-06FS/EU/ 21 DOOR LT EXT COLUMN	1.000	PCS																														
0B1199A2	LEFT 0711-06FS/EU/ 21 DOOR RT INT COLUMN	1.000	PCS																														
0B1200A2	LEFT 0711-06FS/EU/ 21 DOOR LT INT COLUMN	1.000	PCS																														
0B1207A0	LEFT 0711-06FS/EU/ 21 DOOR RT EXT COLUMN	1.000	PCS																														





COMPOSANT			PIÈCE DE RECHANGE					
Code	Description	Image	Code	Description	Composants du kit			
VT1277A	VITRE EXT SER XEVC-0711-E		KDR1328A	PORTE EXTERNE 0711 ZERO GAUCHE -M	Code	Description	Qté	UOM
					0B1216B0	MM DOUBLE GLASS DOOR 750mm UPPER BEAM	1.000	PCS
					0B1217A1	X_TRAVERS SUPERIEUR INT PORTE 750 S6 2V	1.000	PCS
					0H2892A0	LED BAR UPPER CAP PLATE	1.000	PCS
					0H2893A0	LED BAR LOWER CAP PLATE	1.000	PCS
					CE1097A0	CABLE BUS MICROFIT 4 POLES SIHF 4	1.000	PCS
					CE1285A0	FERRITE EMI ROUND MOD. 2643801502	2.000	PCS
					CE1851A0	CABLE Y MICROFIT 2P M-F-F-AWG22	1.000	PCS
					CE2001A0	CABLE MICROFIT 2PM-100-2PM 2AWG22	1.000	PCS
					CE2002A0	CABLE MICROFIT 2PM-100-AMP MODU2 2AWG22	1.000	PCS
					GN1525A0	O-RING INT DIAM 9,5 THK 1 NBR 70	2.000	PCS
					LP1020A0	BARRE ECLAIRAGE LED MM L400 E583	1.000	PCS
					MG1099A1	POIGNEE COMPLETE MMc	1.000	PCS
					RC1200A0	RESSORT A COMPRESSIO N DE=4 DFIL=0.5	4.000	PCS
					SL1170A1	SILICONE ANTHRACITE S57 CARTOUCHE 310ml	37.000	ML
SL1221A0	GN1/1 EXTERNAL GLASS UPPER SILICONE	1.000	PCS					





COMPOSANT			PIÈCE DE RECHANGE																																																																						
Code	Description	Image	Code	Description	Composants du kit																																																																				
VT1277A	VITRE EXT SER XEVC-0711-E		KDR1328A	PORTE EXTERNE 0711 ZERO GAUCHE -M	<table border="1"> <thead> <tr> <th>Code</th> <th>Description</th> <th>Qté</th> <th>UOM</th> </tr> </thead> <tbody> <tr> <td>SL1224A0</td> <td>0711 EXTERNAL GLASS LATERAL SILICONE</td> <td>4.000</td> <td>PCS</td> </tr> <tr> <td>VE1030A1</td> <td>AIMANT D=22,9mm POUR MICROPORTE</td> <td>1.000</td> <td>PCS</td> </tr> <tr> <td>VI0239A1</td> <td>VIS AUTOPERCEU SE 4.2X25 TCB+INOX</td> <td>4.000</td> <td>PCS</td> </tr> <tr> <td>VI1034A0</td> <td>STAINLESS STEEL WASHER 8.4x16x1</td> <td>1.000</td> <td>PCS</td> </tr> <tr> <td>VI1074A0</td> <td>VIS POUR PLASTIQUE 4X16 TCB+INO</td> <td>2.000</td> <td>PCS</td> </tr> <tr> <td>VI1103A0</td> <td>VIS POUR PLASTIQUE 40X12 TPBS+INOX</td> <td>2.000</td> <td>PCS</td> </tr> <tr> <td>VI1220A1</td> <td>VIS AUTOTARADE UX 4.2x12 TCB MARUTEX PRE</td> <td>26.000</td> <td>PCS</td> </tr> <tr> <td>VI1565A0</td> <td>FR-RONDELLA Di=4 De=20 Sp=12/10 INOX</td> <td>1.000</td> <td>PCS</td> </tr> <tr> <td>VI1930A1</td> <td>VIS 5X20 AGGLOMERE INOX</td> <td>16.000</td> <td>PCS</td> </tr> <tr> <td>VI1996A0</td> <td>VIS M5x35 TCEI ZN</td> <td>13.000</td> <td>PCS</td> </tr> <tr> <td>VI2070A0</td> <td>VIS 40X8 TCB+ SHEETTRACS</td> <td>6.000</td> <td>PCS</td> </tr> <tr> <td>VM1490A0</td> <td>COUVERTURE VIS POIGNEE CT BT</td> <td>2.000</td> <td>PCS</td> </tr> <tr> <td>VM1630A1</td> <td>BOUCHON POUSSE-VITR E INTERNE</td> <td>3.000</td> <td>PCS</td> </tr> <tr> <td>VM1631A0</td> <td>BOUCHON POUSSE-VITR E INTERNE PLUS</td> <td>3.000</td> <td>PCS</td> </tr> <tr> <td>VM2267A0</td> <td>GLISSEUR SYSTEME BLOCAGE VITRE INT.</td> <td>2.000</td> <td>PCS</td> </tr> <tr> <td>VM2268A0</td> <td>DOOR MAGNET COVER</td> <td>2.000</td> <td>PCS</td> </tr> </tbody> </table>	Code	Description	Qté	UOM	SL1224A0	0711 EXTERNAL GLASS LATERAL SILICONE	4.000	PCS	VE1030A1	AIMANT D=22,9mm POUR MICROPORTE	1.000	PCS	VI0239A1	VIS AUTOPERCEU SE 4.2X25 TCB+INOX	4.000	PCS	VI1034A0	STAINLESS STEEL WASHER 8.4x16x1	1.000	PCS	VI1074A0	VIS POUR PLASTIQUE 4X16 TCB+INO	2.000	PCS	VI1103A0	VIS POUR PLASTIQUE 40X12 TPBS+INOX	2.000	PCS	VI1220A1	VIS AUTOTARADE UX 4.2x12 TCB MARUTEX PRE	26.000	PCS	VI1565A0	FR-RONDELLA Di=4 De=20 Sp=12/10 INOX	1.000	PCS	VI1930A1	VIS 5X20 AGGLOMERE INOX	16.000	PCS	VI1996A0	VIS M5x35 TCEI ZN	13.000	PCS	VI2070A0	VIS 40X8 TCB+ SHEETTRACS	6.000	PCS	VM1490A0	COUVERTURE VIS POIGNEE CT BT	2.000	PCS	VM1630A1	BOUCHON POUSSE-VITR E INTERNE	3.000	PCS	VM1631A0	BOUCHON POUSSE-VITR E INTERNE PLUS	3.000	PCS	VM2267A0	GLISSEUR SYSTEME BLOCAGE VITRE INT.	2.000	PCS	VM2268A0	DOOR MAGNET COVER	2.000	PCS
					Code	Description	Qté	UOM																																																																	
					SL1224A0	0711 EXTERNAL GLASS LATERAL SILICONE	4.000	PCS																																																																	
					VE1030A1	AIMANT D=22,9mm POUR MICROPORTE	1.000	PCS																																																																	
					VI0239A1	VIS AUTOPERCEU SE 4.2X25 TCB+INOX	4.000	PCS																																																																	
					VI1034A0	STAINLESS STEEL WASHER 8.4x16x1	1.000	PCS																																																																	
					VI1074A0	VIS POUR PLASTIQUE 4X16 TCB+INO	2.000	PCS																																																																	
					VI1103A0	VIS POUR PLASTIQUE 40X12 TPBS+INOX	2.000	PCS																																																																	
					VI1220A1	VIS AUTOTARADE UX 4.2x12 TCB MARUTEX PRE	26.000	PCS																																																																	
					VI1565A0	FR-RONDELLA Di=4 De=20 Sp=12/10 INOX	1.000	PCS																																																																	
					VI1930A1	VIS 5X20 AGGLOMERE INOX	16.000	PCS																																																																	
					VI1996A0	VIS M5x35 TCEI ZN	13.000	PCS																																																																	
					VI2070A0	VIS 40X8 TCB+ SHEETTRACS	6.000	PCS																																																																	
					VM1490A0	COUVERTURE VIS POIGNEE CT BT	2.000	PCS																																																																	
					VM1630A1	BOUCHON POUSSE-VITR E INTERNE	3.000	PCS																																																																	
VM1631A0	BOUCHON POUSSE-VITR E INTERNE PLUS	3.000	PCS																																																																						
VM2267A0	GLISSEUR SYSTEME BLOCAGE VITRE INT.	2.000	PCS																																																																						
VM2268A0	DOOR MAGNET COVER	2.000	PCS																																																																						

COMPOSANT			PIÈCE DE RECHANGE																																																																										
Code	Description	Image	Code	Description	Composants du kit																																																																								
VT1277A	VITRE EXT SER XEVC-0711-E		KDR1328A	PORTE EXTERNE 0711 ZERO GAUCHE -M	<table border="1"> <thead> <tr> <th>Code</th> <th>Description</th> <th>Qté</th> <th>UOM</th> </tr> </thead> <tbody> <tr> <td>VM2269B0</td> <td>INNER GLASS FIXING CAP</td> <td>2.000</td> <td>PCS</td> </tr> <tr> <td>VM2274A0</td> <td>DOUILLE RAINUREE COURTE</td> <td>1.000</td> <td>PCS</td> </tr> <tr> <td>VM2275A0</td> <td>DOUILLE LISSE COURT</td> <td>1.000</td> <td>PCS</td> </tr> <tr> <td>VM2284B0</td> <td>KIT PROFIL GOUTTES SERIE 750</td> <td>1.000</td> <td>PCS</td> </tr> <tr> <td>VM2305A0</td> <td>DOUILLE DE FIXATION BOUCHON PORTE MM</td> <td>14.000</td> <td>PCS</td> </tr> <tr> <td>VM2313A0</td> <td>MM DRIP TRAY RIGHT DRAIN PIPE</td> <td>1.000</td> <td>PCS</td> </tr> <tr> <td>VM2314A0</td> <td>MM DRIP PROFILE CAP</td> <td>1.000</td> <td>PCS</td> </tr> <tr> <td>VM2315B0</td> <td>MM - M INNER GLASS PUSHING CAP HOLDER</td> <td>3.000</td> <td>PCS</td> </tr> <tr> <td>VM2383B0</td> <td>BOUCHON SUP DROIT PORTE MM GAUCHE</td> <td>1.000</td> <td>PCS</td> </tr> <tr> <td>VM2384B0</td> <td>MM LEFT DOOR RIGHT LOWER CAP</td> <td>1.000</td> <td>PCS</td> </tr> <tr> <td>VM2385B0</td> <td>MM LEFT DOOR UPPER LEFT CAP</td> <td>1.000</td> <td>PCS</td> </tr> <tr> <td>VM2386B0</td> <td>BOUCHON INF GAUCHE PORTE S6 GAUCHE</td> <td>1.000</td> <td>PCS</td> </tr> <tr> <td>VM2410A0</td> <td>PLAQUETTE ARRET EXTRUDE BARRE LED</td> <td>1.000</td> <td>PCS</td> </tr> <tr> <td>VM2505B1</td> <td>SUPPORT PUSSE-VITRE INTERNE MM PLUS</td> <td>3.000</td> <td>PCS</td> </tr> <tr> <td>VP1080A0</td> <td>BOUCHON SUP CHERNIERE VITRE INTER INF</td> <td>1.000</td> <td>PCS</td> </tr> <tr> <td>VP1081A0</td> <td>BOUCHON SUP CHARNIERE VITRE INT SUP</td> <td>1.000</td> <td>PCS</td> </tr> <tr> <td>VT1277A0</td> <td>VITRE EXT SER XEVC-0711-E</td> <td>1.000</td> <td>PCS</td> </tr> </tbody> </table>	Code	Description	Qté	UOM	VM2269B0	INNER GLASS FIXING CAP	2.000	PCS	VM2274A0	DOUILLE RAINUREE COURTE	1.000	PCS	VM2275A0	DOUILLE LISSE COURT	1.000	PCS	VM2284B0	KIT PROFIL GOUTTES SERIE 750	1.000	PCS	VM2305A0	DOUILLE DE FIXATION BOUCHON PORTE MM	14.000	PCS	VM2313A0	MM DRIP TRAY RIGHT DRAIN PIPE	1.000	PCS	VM2314A0	MM DRIP PROFILE CAP	1.000	PCS	VM2315B0	MM - M INNER GLASS PUSHING CAP HOLDER	3.000	PCS	VM2383B0	BOUCHON SUP DROIT PORTE MM GAUCHE	1.000	PCS	VM2384B0	MM LEFT DOOR RIGHT LOWER CAP	1.000	PCS	VM2385B0	MM LEFT DOOR UPPER LEFT CAP	1.000	PCS	VM2386B0	BOUCHON INF GAUCHE PORTE S6 GAUCHE	1.000	PCS	VM2410A0	PLAQUETTE ARRET EXTRUDE BARRE LED	1.000	PCS	VM2505B1	SUPPORT PUSSE-VITRE INTERNE MM PLUS	3.000	PCS	VP1080A0	BOUCHON SUP CHERNIERE VITRE INTER INF	1.000	PCS	VP1081A0	BOUCHON SUP CHARNIERE VITRE INT SUP	1.000	PCS	VT1277A0	VITRE EXT SER XEVC-0711-E	1.000	PCS
					Code	Description	Qté	UOM																																																																					
					VM2269B0	INNER GLASS FIXING CAP	2.000	PCS																																																																					
					VM2274A0	DOUILLE RAINUREE COURTE	1.000	PCS																																																																					
					VM2275A0	DOUILLE LISSE COURT	1.000	PCS																																																																					
					VM2284B0	KIT PROFIL GOUTTES SERIE 750	1.000	PCS																																																																					
					VM2305A0	DOUILLE DE FIXATION BOUCHON PORTE MM	14.000	PCS																																																																					
					VM2313A0	MM DRIP TRAY RIGHT DRAIN PIPE	1.000	PCS																																																																					
					VM2314A0	MM DRIP PROFILE CAP	1.000	PCS																																																																					
					VM2315B0	MM - M INNER GLASS PUSHING CAP HOLDER	3.000	PCS																																																																					
					VM2383B0	BOUCHON SUP DROIT PORTE MM GAUCHE	1.000	PCS																																																																					
					VM2384B0	MM LEFT DOOR RIGHT LOWER CAP	1.000	PCS																																																																					
					VM2385B0	MM LEFT DOOR UPPER LEFT CAP	1.000	PCS																																																																					
					VM2386B0	BOUCHON INF GAUCHE PORTE S6 GAUCHE	1.000	PCS																																																																					
					VM2410A0	PLAQUETTE ARRET EXTRUDE BARRE LED	1.000	PCS																																																																					
					VM2505B1	SUPPORT PUSSE-VITRE INTERNE MM PLUS	3.000	PCS																																																																					
					VP1080A0	BOUCHON SUP CHERNIERE VITRE INTER INF	1.000	PCS																																																																					
					VP1081A0	BOUCHON SUP CHARNIERE VITRE INT SUP	1.000	PCS																																																																					
					VT1277A0	VITRE EXT SER XEVC-0711-E	1.000	PCS																																																																					

COMPOSANT			PIÈCE DE RECHANGE																																																																						
Code	Description	Image	Code	Description	Composants du kit																																																																				
VT1277A	VITRE EXT SER XEVC-0711-E		KDR1327A	PORTE EXTERNE 0711 ZERO DROITE -	<table border="1"> <thead> <tr> <th>Code</th> <th>Description</th> <th>Qté</th> <th>UOM</th> </tr> </thead> <tbody> <tr> <td>0B1111A0</td> <td>XEVC-0711-E LEFT EXT DOOR COLUM</td> <td>1.000</td> <td>PCS</td> </tr> <tr> <td>0B1112A2</td> <td>0711 RIGHT - DOOR LEFT INT COLUMN</td> <td>1.000</td> <td>PCS</td> </tr> <tr> <td>0B1113B1</td> <td>COLONNE EXT DROITE PORTE XEVC-0711</td> <td>1.000</td> <td>PCS</td> </tr> <tr> <td>0B1114A2</td> <td>0711 RIGHT - DOOR RIGHT INT COLUMN</td> <td>1.000</td> <td>PCS</td> </tr> <tr> <td>0B1122B0</td> <td>MM CT 750mm DOOR LOWER BEAM</td> <td>1.000</td> <td>PCS</td> </tr> <tr> <td>0B1167A0</td> <td>PROFIL SUPPORT VITRE EXT XEVC-0711-E</td> <td>2.000</td> <td>PCS</td> </tr> <tr> <td>0B1216B0</td> <td>MM DOUBLE GLASS DOOR 750mm UPPER BEAM</td> <td>1.000</td> <td>PCS</td> </tr> <tr> <td>0B1217A1</td> <td>X_TRAVERS SUPERIEUR INT PORTE 750 S6 2V</td> <td>1.000</td> <td>PCS</td> </tr> <tr> <td>0H2892A0</td> <td>LED BAR UPPER CAP PLATE</td> <td>1.000</td> <td>PCS</td> </tr> <tr> <td>0H2893A0</td> <td>LED BAR LOWER CAP PLATE</td> <td>1.000</td> <td>PCS</td> </tr> <tr> <td>CE1097A0</td> <td>CABLE BUS MICROFIT 4 POLES SIHF 4</td> <td>1.000</td> <td>PCS</td> </tr> <tr> <td>CE1285A0</td> <td>FERRITE EMI ROUND MOD. 2643801502</td> <td>2.000</td> <td>PCS</td> </tr> <tr> <td>CE1851A0</td> <td>CABLE Y MICROFIT 2P M-F-F-AWG22</td> <td>1.000</td> <td>PCS</td> </tr> <tr> <td>CE2001A0</td> <td>CABLE MICROFIT 2PM-100-2PM 2AWG22</td> <td>1.000</td> <td>PCS</td> </tr> <tr> <td>CE2002A0</td> <td>CABLE MICROFIT 2PM-100-AMP MODU2 2AWG22</td> <td>1.000</td> <td>PCS</td> </tr> <tr> <td>GN1525A0</td> <td>O-RING INT DIAM 9,5 THK 1 NBR 70</td> <td>1.000</td> <td>PCS</td> </tr> </tbody> </table>	Code	Description	Qté	UOM	0B1111A0	XEVC-0711-E LEFT EXT DOOR COLUM	1.000	PCS	0B1112A2	0711 RIGHT - DOOR LEFT INT COLUMN	1.000	PCS	0B1113B1	COLONNE EXT DROITE PORTE XEVC-0711	1.000	PCS	0B1114A2	0711 RIGHT - DOOR RIGHT INT COLUMN	1.000	PCS	0B1122B0	MM CT 750mm DOOR LOWER BEAM	1.000	PCS	0B1167A0	PROFIL SUPPORT VITRE EXT XEVC-0711-E	2.000	PCS	0B1216B0	MM DOUBLE GLASS DOOR 750mm UPPER BEAM	1.000	PCS	0B1217A1	X_TRAVERS SUPERIEUR INT PORTE 750 S6 2V	1.000	PCS	0H2892A0	LED BAR UPPER CAP PLATE	1.000	PCS	0H2893A0	LED BAR LOWER CAP PLATE	1.000	PCS	CE1097A0	CABLE BUS MICROFIT 4 POLES SIHF 4	1.000	PCS	CE1285A0	FERRITE EMI ROUND MOD. 2643801502	2.000	PCS	CE1851A0	CABLE Y MICROFIT 2P M-F-F-AWG22	1.000	PCS	CE2001A0	CABLE MICROFIT 2PM-100-2PM 2AWG22	1.000	PCS	CE2002A0	CABLE MICROFIT 2PM-100-AMP MODU2 2AWG22	1.000	PCS	GN1525A0	O-RING INT DIAM 9,5 THK 1 NBR 70	1.000	PCS
					Code	Description	Qté	UOM																																																																	
					0B1111A0	XEVC-0711-E LEFT EXT DOOR COLUM	1.000	PCS																																																																	
					0B1112A2	0711 RIGHT - DOOR LEFT INT COLUMN	1.000	PCS																																																																	
					0B1113B1	COLONNE EXT DROITE PORTE XEVC-0711	1.000	PCS																																																																	
					0B1114A2	0711 RIGHT - DOOR RIGHT INT COLUMN	1.000	PCS																																																																	
					0B1122B0	MM CT 750mm DOOR LOWER BEAM	1.000	PCS																																																																	
					0B1167A0	PROFIL SUPPORT VITRE EXT XEVC-0711-E	2.000	PCS																																																																	
					0B1216B0	MM DOUBLE GLASS DOOR 750mm UPPER BEAM	1.000	PCS																																																																	
					0B1217A1	X_TRAVERS SUPERIEUR INT PORTE 750 S6 2V	1.000	PCS																																																																	
					0H2892A0	LED BAR UPPER CAP PLATE	1.000	PCS																																																																	
					0H2893A0	LED BAR LOWER CAP PLATE	1.000	PCS																																																																	
					CE1097A0	CABLE BUS MICROFIT 4 POLES SIHF 4	1.000	PCS																																																																	
					CE1285A0	FERRITE EMI ROUND MOD. 2643801502	2.000	PCS																																																																	
CE1851A0	CABLE Y MICROFIT 2P M-F-F-AWG22	1.000	PCS																																																																						
CE2001A0	CABLE MICROFIT 2PM-100-2PM 2AWG22	1.000	PCS																																																																						
CE2002A0	CABLE MICROFIT 2PM-100-AMP MODU2 2AWG22	1.000	PCS																																																																						
GN1525A0	O-RING INT DIAM 9,5 THK 1 NBR 70	1.000	PCS																																																																						

COMPOSANT			PIÈCE DE RECHANGE																																																														
Code	Description	Image	Code	Description	Composants du kit																																																												
VT1277A	VITRE EXT SER XEVC-0711-E		KDR1327A	PORTE EXTERNE 0711 ZERO DROITE -	<table border="1"> <thead> <tr> <th>Code</th> <th>Description</th> <th>Qté</th> <th>UOM</th> </tr> </thead> <tbody> <tr> <td>LP1020A0</td> <td>BARRE ECLAIRAGE LED MM L400 E583</td> <td>1.000</td> <td>PCS</td> </tr> <tr> <td>MG1099A1</td> <td>POIGNEE COMPLETE MMc</td> <td>1.000</td> <td>PCS</td> </tr> <tr> <td>RC1200A0</td> <td>RESSORT A COMPRESSIO N DE=4 DFIL=0.5</td> <td>4.000</td> <td>PCS</td> </tr> <tr> <td>SL1170A1</td> <td>SILICONE ANTHRACITE S57 CARTOUCHE 310ml</td> <td>37.000</td> <td>ML</td> </tr> <tr> <td>SL1221A0</td> <td>GN1/1 EXTERNAL GLASS UPPER SILICONE</td> <td>1.000</td> <td>PCS</td> </tr> <tr> <td>SL1224A0</td> <td>0711 EXTERNAL GLASS LATERAL SILICONE</td> <td>4.000</td> <td>PCS</td> </tr> <tr> <td>VE1030A1</td> <td>AIMANT D=22,9mm POUR MICROPORTE</td> <td>1.000</td> <td>PCS</td> </tr> <tr> <td>VI0239A1</td> <td>VIS AUTOPERCEU SE 4.2X25 TCB+INOX</td> <td>4.000</td> <td>PCS</td> </tr> <tr> <td>VI1034A0</td> <td>STAINLESS STEEL WASHER 8.4x16x1</td> <td>1.000</td> <td>PCS</td> </tr> <tr> <td>VI1074A0</td> <td>VIS POUR PLASTIQUE 4X16 TCB+INO</td> <td>2.000</td> <td>PCS</td> </tr> <tr> <td>VI1103A0</td> <td>VIS POUR PLASTIQUE 40X12 TPBS+INOX</td> <td>2.000</td> <td>PCS</td> </tr> <tr> <td>VI1220A1</td> <td>VIS AUTOTARADE UX 4.2x12 TCB MARUTEX PRE</td> <td>26.000</td> <td>PCS</td> </tr> <tr> <td>VI1565A0</td> <td>FR-RONDELLA Di=4 De=20 Sp=12/10 INOX</td> <td>1.000</td> <td>PCS</td> </tr> <tr> <td>VI1930A1</td> <td>VIS 5X20 AGGLOMERE INOX</td> <td>16.000</td> <td>PCS</td> </tr> </tbody> </table>	Code	Description	Qté	UOM	LP1020A0	BARRE ECLAIRAGE LED MM L400 E583	1.000	PCS	MG1099A1	POIGNEE COMPLETE MMc	1.000	PCS	RC1200A0	RESSORT A COMPRESSIO N DE=4 DFIL=0.5	4.000	PCS	SL1170A1	SILICONE ANTHRACITE S57 CARTOUCHE 310ml	37.000	ML	SL1221A0	GN1/1 EXTERNAL GLASS UPPER SILICONE	1.000	PCS	SL1224A0	0711 EXTERNAL GLASS LATERAL SILICONE	4.000	PCS	VE1030A1	AIMANT D=22,9mm POUR MICROPORTE	1.000	PCS	VI0239A1	VIS AUTOPERCEU SE 4.2X25 TCB+INOX	4.000	PCS	VI1034A0	STAINLESS STEEL WASHER 8.4x16x1	1.000	PCS	VI1074A0	VIS POUR PLASTIQUE 4X16 TCB+INO	2.000	PCS	VI1103A0	VIS POUR PLASTIQUE 40X12 TPBS+INOX	2.000	PCS	VI1220A1	VIS AUTOTARADE UX 4.2x12 TCB MARUTEX PRE	26.000	PCS	VI1565A0	FR-RONDELLA Di=4 De=20 Sp=12/10 INOX	1.000	PCS	VI1930A1	VIS 5X20 AGGLOMERE INOX	16.000	PCS
					Code	Description	Qté	UOM																																																									
					LP1020A0	BARRE ECLAIRAGE LED MM L400 E583	1.000	PCS																																																									
					MG1099A1	POIGNEE COMPLETE MMc	1.000	PCS																																																									
					RC1200A0	RESSORT A COMPRESSIO N DE=4 DFIL=0.5	4.000	PCS																																																									
					SL1170A1	SILICONE ANTHRACITE S57 CARTOUCHE 310ml	37.000	ML																																																									
					SL1221A0	GN1/1 EXTERNAL GLASS UPPER SILICONE	1.000	PCS																																																									
					SL1224A0	0711 EXTERNAL GLASS LATERAL SILICONE	4.000	PCS																																																									
					VE1030A1	AIMANT D=22,9mm POUR MICROPORTE	1.000	PCS																																																									
					VI0239A1	VIS AUTOPERCEU SE 4.2X25 TCB+INOX	4.000	PCS																																																									
					VI1034A0	STAINLESS STEEL WASHER 8.4x16x1	1.000	PCS																																																									
					VI1074A0	VIS POUR PLASTIQUE 4X16 TCB+INO	2.000	PCS																																																									
					VI1103A0	VIS POUR PLASTIQUE 40X12 TPBS+INOX	2.000	PCS																																																									
					VI1220A1	VIS AUTOTARADE UX 4.2x12 TCB MARUTEX PRE	26.000	PCS																																																									
					VI1565A0	FR-RONDELLA Di=4 De=20 Sp=12/10 INOX	1.000	PCS																																																									
VI1930A1	VIS 5X20 AGGLOMERE INOX	16.000	PCS																																																														

COMPOSANT			PIÈCE DE RECHANGE																																																																																		
Code	Description	Image	Code	Description	Composants du kit																																																																																
VT1277A	VITRE EXT SER XEVC-0711-E		KDR1327A	PORTE EXTERNE 0711 ZERO DROITE -	<table border="1"> <thead> <tr> <th>Code</th> <th>Description</th> <th>Qté</th> <th>UOM</th> </tr> </thead> <tbody> <tr> <td>VI1996A0</td> <td>VIS M5x35 TCEI ZN</td> <td>13.000</td> <td>PCS</td> </tr> <tr> <td>VI2070A0</td> <td>VIS 40x8 TCB+ SHEETTRACS</td> <td>6.000</td> <td>PCS</td> </tr> <tr> <td>VM1490A0</td> <td>COUVERTURE VIS POIGNEE CT BT</td> <td>2.000</td> <td>PCS</td> </tr> <tr> <td>VM1630A1</td> <td>BOUCHON POUSSE-VITR E INTERNE</td> <td>3.000</td> <td>PCS</td> </tr> <tr> <td>VM1631A0</td> <td>BOUCHON POUSSE-VITR E INTERNE PLUS</td> <td>3.000</td> <td>PCS</td> </tr> <tr> <td>VM2259B0</td> <td></td> <td>1.000</td> <td>PCS</td> </tr> <tr> <td>VM2260B0</td> <td>S6 LEFT UPPER CAP</td> <td>1.000</td> <td>PCS</td> </tr> <tr> <td>VM2261B0</td> <td>MM -M DOOR RIGHT LOWER CAP</td> <td>1.000</td> <td>PCS</td> </tr> <tr> <td>VM2262B0</td> <td>MM -M DOOR RIGHT UPPER CAP</td> <td>1.000</td> <td>PCS</td> </tr> <tr> <td>VM2267A0</td> <td>GLISSEUR SYSTEME BLOCAGE VITRE INT.</td> <td>2.000</td> <td>PCS</td> </tr> <tr> <td>VM2268A0</td> <td>DOOR MAGNET COVER</td> <td>2.000</td> <td>PCS</td> </tr> <tr> <td>VM2269B0</td> <td>INNER GLASS FIXING CAP</td> <td>2.000</td> <td>PCS</td> </tr> <tr> <td>VM2274A0</td> <td>DOUILLE RAINUREE COURTE</td> <td>1.000</td> <td>PCS</td> </tr> <tr> <td>VM2275A0</td> <td>DOUILLE LISSE COURT</td> <td>1.000</td> <td>PCS</td> </tr> <tr> <td>VM2284B0</td> <td>KIT PROFIL GOUTTES SERIE 750</td> <td>1.000</td> <td>PCS</td> </tr> <tr> <td>VM2305A0</td> <td>DOUILLE DE FIXATION BOUCHON PORTE MM</td> <td>14.000</td> <td>PCS</td> </tr> <tr> <td>VM2312A0</td> <td>TUBE GAUCHE DECHARGE EGOUTTEMEN T MM</td> <td>1.000</td> <td>PCS</td> </tr> <tr> <td>VM2314A0</td> <td>MM DRIP PROFILE CAP</td> <td>1.000</td> <td>PCS</td> </tr> <tr> <td>VM2315B0</td> <td>MM - M INNER GLASS PUSHING CAP HOLDER</td> <td>3.000</td> <td>PCS</td> </tr> </tbody> </table>	Code	Description	Qté	UOM	VI1996A0	VIS M5x35 TCEI ZN	13.000	PCS	VI2070A0	VIS 40x8 TCB+ SHEETTRACS	6.000	PCS	VM1490A0	COUVERTURE VIS POIGNEE CT BT	2.000	PCS	VM1630A1	BOUCHON POUSSE-VITR E INTERNE	3.000	PCS	VM1631A0	BOUCHON POUSSE-VITR E INTERNE PLUS	3.000	PCS	VM2259B0		1.000	PCS	VM2260B0	S6 LEFT UPPER CAP	1.000	PCS	VM2261B0	MM -M DOOR RIGHT LOWER CAP	1.000	PCS	VM2262B0	MM -M DOOR RIGHT UPPER CAP	1.000	PCS	VM2267A0	GLISSEUR SYSTEME BLOCAGE VITRE INT.	2.000	PCS	VM2268A0	DOOR MAGNET COVER	2.000	PCS	VM2269B0	INNER GLASS FIXING CAP	2.000	PCS	VM2274A0	DOUILLE RAINUREE COURTE	1.000	PCS	VM2275A0	DOUILLE LISSE COURT	1.000	PCS	VM2284B0	KIT PROFIL GOUTTES SERIE 750	1.000	PCS	VM2305A0	DOUILLE DE FIXATION BOUCHON PORTE MM	14.000	PCS	VM2312A0	TUBE GAUCHE DECHARGE EGOUTTEMEN T MM	1.000	PCS	VM2314A0	MM DRIP PROFILE CAP	1.000	PCS	VM2315B0	MM - M INNER GLASS PUSHING CAP HOLDER	3.000	PCS
					Code	Description	Qté	UOM																																																																													
VI1996A0	VIS M5x35 TCEI ZN	13.000	PCS																																																																																		
VI2070A0	VIS 40x8 TCB+ SHEETTRACS	6.000	PCS																																																																																		
VM1490A0	COUVERTURE VIS POIGNEE CT BT	2.000	PCS																																																																																		
VM1630A1	BOUCHON POUSSE-VITR E INTERNE	3.000	PCS																																																																																		
VM1631A0	BOUCHON POUSSE-VITR E INTERNE PLUS	3.000	PCS																																																																																		
VM2259B0		1.000	PCS																																																																																		
VM2260B0	S6 LEFT UPPER CAP	1.000	PCS																																																																																		
VM2261B0	MM -M DOOR RIGHT LOWER CAP	1.000	PCS																																																																																		
VM2262B0	MM -M DOOR RIGHT UPPER CAP	1.000	PCS																																																																																		
VM2267A0	GLISSEUR SYSTEME BLOCAGE VITRE INT.	2.000	PCS																																																																																		
VM2268A0	DOOR MAGNET COVER	2.000	PCS																																																																																		
VM2269B0	INNER GLASS FIXING CAP	2.000	PCS																																																																																		
VM2274A0	DOUILLE RAINUREE COURTE	1.000	PCS																																																																																		
VM2275A0	DOUILLE LISSE COURT	1.000	PCS																																																																																		
VM2284B0	KIT PROFIL GOUTTES SERIE 750	1.000	PCS																																																																																		
VM2305A0	DOUILLE DE FIXATION BOUCHON PORTE MM	14.000	PCS																																																																																		
VM2312A0	TUBE GAUCHE DECHARGE EGOUTTEMEN T MM	1.000	PCS																																																																																		
VM2314A0	MM DRIP PROFILE CAP	1.000	PCS																																																																																		
VM2315B0	MM - M INNER GLASS PUSHING CAP HOLDER	3.000	PCS																																																																																		

COMPOSANT			PIÈCE DE RECHANGE																																			
Code	Description	Image	Code	Description	Composants du kit																																	
VT1277A	VITRE EXT SER XEVC-0711-E		KDR1327A	PORTE EXTERNE 0711 ZERO DROITE -	<table border="1"> <thead> <tr> <th>Code</th> <th>Description</th> <th>Qté</th> <th>UOM</th> </tr> </thead> <tbody> <tr> <td>VM2410A0</td> <td>PLAQUETTE ARRET EXTRUDE BARRE LED</td> <td>1.000</td> <td>PCS</td> </tr> <tr> <td>VM2505B1</td> <td>SUPPORT PUSSE-VITRE INTERNE MM PLUS</td> <td>3.000</td> <td>PCS</td> </tr> <tr> <td>VP1080A0</td> <td>BOUCHON SUP CHARNIERE VITRE INTER INF</td> <td>1.000</td> <td>PCS</td> </tr> <tr> <td>VP1081A0</td> <td>BOUCHON SUP CHARNIERE VITRE INT SUP</td> <td>1.000</td> <td>PCS</td> </tr> <tr> <td>VT1277A0</td> <td>VITRE EXT SER XEVC-0711-E</td> <td>1.000</td> <td>PCS</td> </tr> </tbody> </table>	Code	Description	Qté	UOM	VM2410A0	PLAQUETTE ARRET EXTRUDE BARRE LED	1.000	PCS	VM2505B1	SUPPORT PUSSE-VITRE INTERNE MM PLUS	3.000	PCS	VP1080A0	BOUCHON SUP CHARNIERE VITRE INTER INF	1.000	PCS	VP1081A0	BOUCHON SUP CHARNIERE VITRE INT SUP	1.000	PCS	VT1277A0	VITRE EXT SER XEVC-0711-E	1.000	PCS									
			Code	Description	Qté	UOM																																
VM2410A0	PLAQUETTE ARRET EXTRUDE BARRE LED	1.000	PCS																																			
VM2505B1	SUPPORT PUSSE-VITRE INTERNE MM PLUS	3.000	PCS																																			
VP1080A0	BOUCHON SUP CHARNIERE VITRE INTER INF	1.000	PCS																																			
VP1081A0	BOUCHON SUP CHARNIERE VITRE INT SUP	1.000	PCS																																			
VT1277A0	VITRE EXT SER XEVC-0711-E	1.000	PCS																																			
KDR1266B	PORTE EXTERNE 0711 GAUCHE -M	<table border="1"> <thead> <tr> <th>Code</th> <th>Description</th> <th>Qté</th> <th>UOM</th> </tr> </thead> <tbody> <tr> <td>0B1122B0</td> <td>MM CT 750mm DOOR LOWER BEAM</td> <td>1.000</td> <td>PCS</td> </tr> <tr> <td>0B1167A0</td> <td>PROFIL SUPPORT VITRE EXT XEVC-0711-E</td> <td>2.000</td> <td>PCS</td> </tr> <tr> <td>0B1198B1</td> <td>LEFT 0711-06FS/EU/ 21 DOOR LT EXT COLUMN</td> <td>1.000</td> <td>PCS</td> </tr> <tr> <td>0B1199A2</td> <td>LEFT 0711-06FS/EU/ 21 DOOR RT INT COLUMN</td> <td>1.000</td> <td>PCS</td> </tr> <tr> <td>0B1200A2</td> <td>LEFT 0711-06FS/EU/ 21 DOOR LT INT COLUMN</td> <td>1.000</td> <td>PCS</td> </tr> <tr> <td>0B1207A0</td> <td>LEFT 0711-06FS/EU/ 21 DOOR RT EXT COLUMN</td> <td>1.000</td> <td>PCS</td> </tr> <tr> <td>0B1216B0</td> <td>MM DOUBLE GLASS DOOR 750mm UPPER BEAM</td> <td>1.000</td> <td>PCS</td> </tr> <tr> <td>0B1217A1</td> <td>X_TRAVERS SUPERIEUR INT PORTE 750 S6 2V</td> <td>1.000</td> <td>PCS</td> </tr> </tbody> </table>	Code	Description	Qté	UOM	0B1122B0	MM CT 750mm DOOR LOWER BEAM	1.000	PCS	0B1167A0	PROFIL SUPPORT VITRE EXT XEVC-0711-E	2.000	PCS	0B1198B1	LEFT 0711-06FS/EU/ 21 DOOR LT EXT COLUMN	1.000	PCS	0B1199A2	LEFT 0711-06FS/EU/ 21 DOOR RT INT COLUMN	1.000	PCS	0B1200A2	LEFT 0711-06FS/EU/ 21 DOOR LT INT COLUMN	1.000	PCS	0B1207A0	LEFT 0711-06FS/EU/ 21 DOOR RT EXT COLUMN	1.000	PCS	0B1216B0	MM DOUBLE GLASS DOOR 750mm UPPER BEAM	1.000	PCS	0B1217A1	X_TRAVERS SUPERIEUR INT PORTE 750 S6 2V	1.000	PCS
Code	Description	Qté	UOM																																			
0B1122B0	MM CT 750mm DOOR LOWER BEAM	1.000	PCS																																			
0B1167A0	PROFIL SUPPORT VITRE EXT XEVC-0711-E	2.000	PCS																																			
0B1198B1	LEFT 0711-06FS/EU/ 21 DOOR LT EXT COLUMN	1.000	PCS																																			
0B1199A2	LEFT 0711-06FS/EU/ 21 DOOR RT INT COLUMN	1.000	PCS																																			
0B1200A2	LEFT 0711-06FS/EU/ 21 DOOR LT INT COLUMN	1.000	PCS																																			
0B1207A0	LEFT 0711-06FS/EU/ 21 DOOR RT EXT COLUMN	1.000	PCS																																			
0B1216B0	MM DOUBLE GLASS DOOR 750mm UPPER BEAM	1.000	PCS																																			
0B1217A1	X_TRAVERS SUPERIEUR INT PORTE 750 S6 2V	1.000	PCS																																			





COMPOSANT			PIÈCE DE RECHANGE																																																														
Code	Description	Image	Code	Description	Composants du kit																																																												
VT1277A	VITRE EXT SER XEVC-0711-E		KDR1266B	PORTE EXTERNE 0711 GAUCHE -M	<table border="1"> <thead> <tr> <th>Code</th> <th>Description</th> <th>Qté</th> <th>UOM</th> </tr> </thead> <tbody> <tr> <td>CE1052A1</td> <td>CABLE DE LIAISON CONTROLE-U SB MM 750MM</td> <td>1.000</td> <td>PCS</td> </tr> <tr> <td>CE1053B0</td> <td>CABLE ALIM BARRE LED MM MICROFIT 2P</td> <td>1.000</td> <td>PCS</td> </tr> <tr> <td>CE1097A0</td> <td>CABLE BUS MICROFIT 4 POLES SIHF 4</td> <td>1.000</td> <td>PCS</td> </tr> <tr> <td>CE1285A0</td> <td>FERRITE EMI ROUND MOD. 2643801502</td> <td>2.000</td> <td>PCS</td> </tr> <tr> <td>GN1525A0</td> <td>O-RING INT DIAM 9,5 THK 1 NBR 70</td> <td>2.000</td> <td>PCS</td> </tr> <tr> <td>LP1020A0</td> <td>BARRE ECLAIRAGE LED MM L400 E583</td> <td>1.000</td> <td>PCS</td> </tr> <tr> <td>LP1026A0</td> <td>EXTRUDE ECLAIRAGE NON LED MM L583</td> <td>1.000</td> <td>PCS</td> </tr> <tr> <td>MG1099A1</td> <td>POIGNEE COMPLETE MMc</td> <td>1.000</td> <td>PCS</td> </tr> <tr> <td>RC1200A0</td> <td>RESSORT A COMPRESSIO N DE=4 DFIL=0.5</td> <td>4.000</td> <td>PCS</td> </tr> <tr> <td>SL1170A1</td> <td>SILICONE ANTHRACITE S57 CARTOUCHE 310ml</td> <td>37.000</td> <td>ML</td> </tr> <tr> <td>SL1221A0</td> <td>GN1/1 EXTERNAL GLASS UPPER SILICONE</td> <td>1.000</td> <td>PCS</td> </tr> <tr> <td>SL1224A0</td> <td>0711 EXTERNAL GLASS LATERAL SILICONE</td> <td>4.000</td> <td>PCS</td> </tr> <tr> <td>VE1030A1</td> <td>AIMANT D=22,9mm POUR MICROPORTE</td> <td>1.000</td> <td>PCS</td> </tr> <tr> <td>VI0239A1</td> <td>VIS AUTOPERCEU SE 4.2X25 TCB+INOX</td> <td>4.000</td> <td>PCS</td> </tr> </tbody> </table>	Code	Description	Qté	UOM	CE1052A1	CABLE DE LIAISON CONTROLE-U SB MM 750MM	1.000	PCS	CE1053B0	CABLE ALIM BARRE LED MM MICROFIT 2P	1.000	PCS	CE1097A0	CABLE BUS MICROFIT 4 POLES SIHF 4	1.000	PCS	CE1285A0	FERRITE EMI ROUND MOD. 2643801502	2.000	PCS	GN1525A0	O-RING INT DIAM 9,5 THK 1 NBR 70	2.000	PCS	LP1020A0	BARRE ECLAIRAGE LED MM L400 E583	1.000	PCS	LP1026A0	EXTRUDE ECLAIRAGE NON LED MM L583	1.000	PCS	MG1099A1	POIGNEE COMPLETE MMc	1.000	PCS	RC1200A0	RESSORT A COMPRESSIO N DE=4 DFIL=0.5	4.000	PCS	SL1170A1	SILICONE ANTHRACITE S57 CARTOUCHE 310ml	37.000	ML	SL1221A0	GN1/1 EXTERNAL GLASS UPPER SILICONE	1.000	PCS	SL1224A0	0711 EXTERNAL GLASS LATERAL SILICONE	4.000	PCS	VE1030A1	AIMANT D=22,9mm POUR MICROPORTE	1.000	PCS	VI0239A1	VIS AUTOPERCEU SE 4.2X25 TCB+INOX	4.000	PCS
					Code	Description	Qté	UOM																																																									
					CE1052A1	CABLE DE LIAISON CONTROLE-U SB MM 750MM	1.000	PCS																																																									
					CE1053B0	CABLE ALIM BARRE LED MM MICROFIT 2P	1.000	PCS																																																									
					CE1097A0	CABLE BUS MICROFIT 4 POLES SIHF 4	1.000	PCS																																																									
					CE1285A0	FERRITE EMI ROUND MOD. 2643801502	2.000	PCS																																																									
					GN1525A0	O-RING INT DIAM 9,5 THK 1 NBR 70	2.000	PCS																																																									
					LP1020A0	BARRE ECLAIRAGE LED MM L400 E583	1.000	PCS																																																									
					LP1026A0	EXTRUDE ECLAIRAGE NON LED MM L583	1.000	PCS																																																									
					MG1099A1	POIGNEE COMPLETE MMc	1.000	PCS																																																									
					RC1200A0	RESSORT A COMPRESSIO N DE=4 DFIL=0.5	4.000	PCS																																																									
					SL1170A1	SILICONE ANTHRACITE S57 CARTOUCHE 310ml	37.000	ML																																																									
					SL1221A0	GN1/1 EXTERNAL GLASS UPPER SILICONE	1.000	PCS																																																									
					SL1224A0	0711 EXTERNAL GLASS LATERAL SILICONE	4.000	PCS																																																									
					VE1030A1	AIMANT D=22,9mm POUR MICROPORTE	1.000	PCS																																																									
VI0239A1	VIS AUTOPERCEU SE 4.2X25 TCB+INOX	4.000	PCS																																																														

COMPOSANT			PIÈCE DE RECHANGE																																																																										
Code	Description	Image	Code	Description	Composants du kit																																																																								
VT1277A	VITRE EXT SER XEVC-0711-E		KDR1266B	PORTE EXTERNE 0711 GAUCHE -M	<table border="1"> <thead> <tr> <th>Code</th> <th>Description</th> <th>Qté</th> <th>UOM</th> </tr> </thead> <tbody> <tr> <td>VI1034A0</td> <td>STAINLESS STEEL WASHER 8.4x16x1</td> <td>1.000</td> <td>PCS</td> </tr> <tr> <td>VI1074A0</td> <td>VIS POUR PLASTIQUE 4X16 TCB+INO</td> <td>2.000</td> <td>PCS</td> </tr> <tr> <td>VI1103A0</td> <td>VIS POUR PLASTIQUE 40X12 TPBS+INOX</td> <td>2.000</td> <td>PCS</td> </tr> <tr> <td>VI1220A1</td> <td>VIS AUTOTARADE UX 4.2x12 TCB MARUTEX PRE</td> <td>26.000</td> <td>PCS</td> </tr> <tr> <td>VI1930A1</td> <td>VIS 5X20 AGGLOMERE INOX</td> <td>16.000</td> <td>PCS</td> </tr> <tr> <td>VI1996A0</td> <td>VIS M5x35 TCEI ZN</td> <td>13.000</td> <td>PCS</td> </tr> <tr> <td>VI2070A0</td> <td>VIS 40x8 TCB+ SHEETTRACS</td> <td>6.000</td> <td>PCS</td> </tr> <tr> <td>VM1490A0</td> <td>COUVERTURE VIS POIGNEE CT BT</td> <td>2.000</td> <td>PCS</td> </tr> <tr> <td>VM1630A1</td> <td>BOUCHON POUSSE-VITR E INTERNE</td> <td>3.000</td> <td>PCS</td> </tr> <tr> <td>VM1631A0</td> <td>BOUCHON POUSSE-VITR E INTERNE PLUS</td> <td>3.000</td> <td>PCS</td> </tr> <tr> <td>VM2267A0</td> <td>GLISSEUR SYSTEME BLOCAGE VITRE INT.</td> <td>2.000</td> <td>PCS</td> </tr> <tr> <td>VM2268A0</td> <td>DOOR MAGNET COVER</td> <td>2.000</td> <td>PCS</td> </tr> <tr> <td>VM2269B0</td> <td>INNER GLASS FIXING CAP</td> <td>2.000</td> <td>PCS</td> </tr> <tr> <td>VM2274A0</td> <td>DOUILLE RAINUREE COURTE</td> <td>1.000</td> <td>PCS</td> </tr> <tr> <td>VM2275A0</td> <td>DOUILLE LISSE COURT</td> <td>1.000</td> <td>PCS</td> </tr> <tr> <td>VM2284B0</td> <td>KIT PROFIL GOUTTES SERIE 750</td> <td>1.000</td> <td>PCS</td> </tr> <tr> <td>VM2305A0</td> <td>DOUILLE DE FIXATION BOUCHON PORTE MM</td> <td>14.000</td> <td>PCS</td> </tr> </tbody> </table>	Code	Description	Qté	UOM	VI1034A0	STAINLESS STEEL WASHER 8.4x16x1	1.000	PCS	VI1074A0	VIS POUR PLASTIQUE 4X16 TCB+INO	2.000	PCS	VI1103A0	VIS POUR PLASTIQUE 40X12 TPBS+INOX	2.000	PCS	VI1220A1	VIS AUTOTARADE UX 4.2x12 TCB MARUTEX PRE	26.000	PCS	VI1930A1	VIS 5X20 AGGLOMERE INOX	16.000	PCS	VI1996A0	VIS M5x35 TCEI ZN	13.000	PCS	VI2070A0	VIS 40x8 TCB+ SHEETTRACS	6.000	PCS	VM1490A0	COUVERTURE VIS POIGNEE CT BT	2.000	PCS	VM1630A1	BOUCHON POUSSE-VITR E INTERNE	3.000	PCS	VM1631A0	BOUCHON POUSSE-VITR E INTERNE PLUS	3.000	PCS	VM2267A0	GLISSEUR SYSTEME BLOCAGE VITRE INT.	2.000	PCS	VM2268A0	DOOR MAGNET COVER	2.000	PCS	VM2269B0	INNER GLASS FIXING CAP	2.000	PCS	VM2274A0	DOUILLE RAINUREE COURTE	1.000	PCS	VM2275A0	DOUILLE LISSE COURT	1.000	PCS	VM2284B0	KIT PROFIL GOUTTES SERIE 750	1.000	PCS	VM2305A0	DOUILLE DE FIXATION BOUCHON PORTE MM	14.000	PCS
					Code	Description	Qté	UOM																																																																					
					VI1034A0	STAINLESS STEEL WASHER 8.4x16x1	1.000	PCS																																																																					
					VI1074A0	VIS POUR PLASTIQUE 4X16 TCB+INO	2.000	PCS																																																																					
					VI1103A0	VIS POUR PLASTIQUE 40X12 TPBS+INOX	2.000	PCS																																																																					
					VI1220A1	VIS AUTOTARADE UX 4.2x12 TCB MARUTEX PRE	26.000	PCS																																																																					
					VI1930A1	VIS 5X20 AGGLOMERE INOX	16.000	PCS																																																																					
					VI1996A0	VIS M5x35 TCEI ZN	13.000	PCS																																																																					
					VI2070A0	VIS 40x8 TCB+ SHEETTRACS	6.000	PCS																																																																					
					VM1490A0	COUVERTURE VIS POIGNEE CT BT	2.000	PCS																																																																					
					VM1630A1	BOUCHON POUSSE-VITR E INTERNE	3.000	PCS																																																																					
					VM1631A0	BOUCHON POUSSE-VITR E INTERNE PLUS	3.000	PCS																																																																					
					VM2267A0	GLISSEUR SYSTEME BLOCAGE VITRE INT.	2.000	PCS																																																																					
					VM2268A0	DOOR MAGNET COVER	2.000	PCS																																																																					
					VM2269B0	INNER GLASS FIXING CAP	2.000	PCS																																																																					
VM2274A0	DOUILLE RAINUREE COURTE	1.000	PCS																																																																										
VM2275A0	DOUILLE LISSE COURT	1.000	PCS																																																																										
VM2284B0	KIT PROFIL GOUTTES SERIE 750	1.000	PCS																																																																										
VM2305A0	DOUILLE DE FIXATION BOUCHON PORTE MM	14.000	PCS																																																																										

COMPOSANT			PIÈCE DE RECHANGE																																																						
Code	Description	Image	Code	Description	Composants du kit																																																				
VT1277A	VITRE EXT SER XEVC-0711-E		KDR1266B	PORTE EXTERNE 0711 GAUCHE -M	<table border="1"> <thead> <tr> <th>Code</th> <th>Description</th> <th>Qté</th> <th>UOM</th> </tr> </thead> <tbody> <tr> <td>VM2313A0</td> <td>MM DRIP TRAY RIGHT DRAIN PIPE</td> <td>1.000</td> <td>PCS</td> </tr> <tr> <td>VM2314A0</td> <td>MM DRIP PROFILE CAP</td> <td>1.000</td> <td>PCS</td> </tr> <tr> <td>VM2315B0</td> <td>MM - M INNER GLASS PUSHING CAP HOLDER</td> <td>3.000</td> <td>PCS</td> </tr> <tr> <td>VM2383B0</td> <td>BOUCHON SUP DROIT PORTE MM GAUCHE</td> <td>1.000</td> <td>PCS</td> </tr> <tr> <td>VM2384B0</td> <td>MM LEFT DOOR RIGHT LOWER CAP</td> <td>1.000</td> <td>PCS</td> </tr> <tr> <td>VM2385B0</td> <td>MM LEFT DOOR UPPER LEFT CAP</td> <td>1.000</td> <td>PCS</td> </tr> <tr> <td>VM2386B0</td> <td>BOUCHON INF GAUCHE PORTE S6 GAUCHE</td> <td>1.000</td> <td>PCS</td> </tr> <tr> <td>VM2410A0</td> <td>PLAQUETTE ARRET EXTRUDE BARRE LED</td> <td>2.000</td> <td>PCS</td> </tr> <tr> <td>VM2505B1</td> <td>SUPPORT PUSSE-VITRE INTERNE MM PLUS</td> <td>3.000</td> <td>PCS</td> </tr> <tr> <td>VP1080A0</td> <td>BOUCHON SUP CHARNIERE VITRE INTER INF</td> <td>1.000</td> <td>PCS</td> </tr> <tr> <td>VP1081A0</td> <td>BOUCHON SUP CHARNIERE VITRE INT SUP</td> <td>1.000</td> <td>PCS</td> </tr> <tr> <td>VT1277A0</td> <td>VITRE EXT SER XEVC-0711-E</td> <td>1.000</td> <td>PCS</td> </tr> </tbody> </table>	Code	Description	Qté	UOM	VM2313A0	MM DRIP TRAY RIGHT DRAIN PIPE	1.000	PCS	VM2314A0	MM DRIP PROFILE CAP	1.000	PCS	VM2315B0	MM - M INNER GLASS PUSHING CAP HOLDER	3.000	PCS	VM2383B0	BOUCHON SUP DROIT PORTE MM GAUCHE	1.000	PCS	VM2384B0	MM LEFT DOOR RIGHT LOWER CAP	1.000	PCS	VM2385B0	MM LEFT DOOR UPPER LEFT CAP	1.000	PCS	VM2386B0	BOUCHON INF GAUCHE PORTE S6 GAUCHE	1.000	PCS	VM2410A0	PLAQUETTE ARRET EXTRUDE BARRE LED	2.000	PCS	VM2505B1	SUPPORT PUSSE-VITRE INTERNE MM PLUS	3.000	PCS	VP1080A0	BOUCHON SUP CHARNIERE VITRE INTER INF	1.000	PCS	VP1081A0	BOUCHON SUP CHARNIERE VITRE INT SUP	1.000	PCS	VT1277A0	VITRE EXT SER XEVC-0711-E	1.000	PCS
			Code	Description	Qté	UOM																																																			
VM2313A0	MM DRIP TRAY RIGHT DRAIN PIPE	1.000	PCS																																																						
VM2314A0	MM DRIP PROFILE CAP	1.000	PCS																																																						
VM2315B0	MM - M INNER GLASS PUSHING CAP HOLDER	3.000	PCS																																																						
VM2383B0	BOUCHON SUP DROIT PORTE MM GAUCHE	1.000	PCS																																																						
VM2384B0	MM LEFT DOOR RIGHT LOWER CAP	1.000	PCS																																																						
VM2385B0	MM LEFT DOOR UPPER LEFT CAP	1.000	PCS																																																						
VM2386B0	BOUCHON INF GAUCHE PORTE S6 GAUCHE	1.000	PCS																																																						
VM2410A0	PLAQUETTE ARRET EXTRUDE BARRE LED	2.000	PCS																																																						
VM2505B1	SUPPORT PUSSE-VITRE INTERNE MM PLUS	3.000	PCS																																																						
VP1080A0	BOUCHON SUP CHARNIERE VITRE INTER INF	1.000	PCS																																																						
VP1081A0	BOUCHON SUP CHARNIERE VITRE INT SUP	1.000	PCS																																																						
VT1277A0	VITRE EXT SER XEVC-0711-E	1.000	PCS																																																						
KDR1266A	PORTE EXTERNE 0711 GAUCHE	<table border="1"> <thead> <tr> <th>Code</th> <th>Description</th> <th>Qté</th> <th>UOM</th> </tr> </thead> <tbody> <tr> <td>0B1122A1</td> <td>750MM DOOR LOWER FRAME SHAPE</td> <td>1.000</td> <td>PCS</td> </tr> <tr> <td>0B1167A0</td> <td>PROFIL SUPPORT VITRE EXT XEVC-0711-E</td> <td>2.000</td> <td>PCS</td> </tr> </tbody> </table>	Code	Description	Qté	UOM	0B1122A1	750MM DOOR LOWER FRAME SHAPE	1.000	PCS	0B1167A0	PROFIL SUPPORT VITRE EXT XEVC-0711-E	2.000	PCS																																											
Code	Description	Qté	UOM																																																						
0B1122A1	750MM DOOR LOWER FRAME SHAPE	1.000	PCS																																																						
0B1167A0	PROFIL SUPPORT VITRE EXT XEVC-0711-E	2.000	PCS																																																						

COMPOSANT			PIÈCE DE RECHANGE																																																														
Code	Description	Image	Code	Description	Composants du kit																																																												
VT1277A	VITRE EXT SER XEVC-0711-E		KDR1266A	PORTE EXTERNE 0711 GAUCHE	<table border="1"> <thead> <tr> <th>Code</th> <th>Description</th> <th>Qté</th> <th>UOM</th> </tr> </thead> <tbody> <tr> <td>0B1198B1</td> <td>LEFT 0711-06FS/EU/ 21 DOOR LT EXT COLUMN</td> <td>1.000</td> <td>PCS</td> </tr> <tr> <td>0B1199A2</td> <td>LEFT 0711-06FS/EU/ 21 DOOR RT INT COLUMN</td> <td>1.000</td> <td>PCS</td> </tr> <tr> <td>0B1200A2</td> <td>LEFT 0711-06FS/EU/ 21 DOOR LT INT COLUMN</td> <td>1.000</td> <td>PCS</td> </tr> <tr> <td>0B1207A0</td> <td>LEFT 0711-06FS/EU/ 21 DOOR RT EXT COLUMN</td> <td>1.000</td> <td>PCS</td> </tr> <tr> <td>0B1216A1</td> <td>TRAVERS SUPERIEUR PORTE MM CT 2V</td> <td>1.000</td> <td>PCS</td> </tr> <tr> <td>0B1217A1</td> <td>X_TRAVERS SUPERIEUR INT PORTE 750 S6 2V</td> <td>1.000</td> <td>PCS</td> </tr> <tr> <td>CE1052A1</td> <td>CABLE DE LIAISON CONTROLE-U SB MM 750MM</td> <td>1.000</td> <td>PCS</td> </tr> <tr> <td>CE1053B0</td> <td>CABLE ALIM BARRE LED MM MICROFIT 2P</td> <td>1.000</td> <td>PCS</td> </tr> <tr> <td>CE1285A0</td> <td>FERRITE EMI ROUND MOD. 2643801502</td> <td>1.000</td> <td>PCS</td> </tr> <tr> <td>CE1290A0</td> <td>BORNE FEMELLE EXTRACTIBLE CPF 5/4</td> <td>1.000</td> <td>PCS</td> </tr> <tr> <td>CE1310A1</td> <td>POWER - CONTROL BOARD CONNECTING CABLE</td> <td>1.000</td> <td>PCS</td> </tr> <tr> <td>GN1525A0</td> <td>O-RING INT DIAM 9,5 THK 1 NBR 70</td> <td>1.000</td> <td>PCS</td> </tr> <tr> <td>LP1020A0</td> <td>BARRE ECLAIRAGE LED MM L400 E583</td> <td>1.000</td> <td>PCS</td> </tr> <tr> <td>LP1026A0</td> <td>EXTRUDE ECLAIRAGE NON LED MM L583</td> <td>1.000</td> <td>PCS</td> </tr> </tbody> </table>	Code	Description	Qté	UOM	0B1198B1	LEFT 0711-06FS/EU/ 21 DOOR LT EXT COLUMN	1.000	PCS	0B1199A2	LEFT 0711-06FS/EU/ 21 DOOR RT INT COLUMN	1.000	PCS	0B1200A2	LEFT 0711-06FS/EU/ 21 DOOR LT INT COLUMN	1.000	PCS	0B1207A0	LEFT 0711-06FS/EU/ 21 DOOR RT EXT COLUMN	1.000	PCS	0B1216A1	TRAVERS SUPERIEUR PORTE MM CT 2V	1.000	PCS	0B1217A1	X_TRAVERS SUPERIEUR INT PORTE 750 S6 2V	1.000	PCS	CE1052A1	CABLE DE LIAISON CONTROLE-U SB MM 750MM	1.000	PCS	CE1053B0	CABLE ALIM BARRE LED MM MICROFIT 2P	1.000	PCS	CE1285A0	FERRITE EMI ROUND MOD. 2643801502	1.000	PCS	CE1290A0	BORNE FEMELLE EXTRACTIBLE CPF 5/4	1.000	PCS	CE1310A1	POWER - CONTROL BOARD CONNECTING CABLE	1.000	PCS	GN1525A0	O-RING INT DIAM 9,5 THK 1 NBR 70	1.000	PCS	LP1020A0	BARRE ECLAIRAGE LED MM L400 E583	1.000	PCS	LP1026A0	EXTRUDE ECLAIRAGE NON LED MM L583	1.000	PCS
					Code	Description	Qté	UOM																																																									
					0B1198B1	LEFT 0711-06FS/EU/ 21 DOOR LT EXT COLUMN	1.000	PCS																																																									
					0B1199A2	LEFT 0711-06FS/EU/ 21 DOOR RT INT COLUMN	1.000	PCS																																																									
					0B1200A2	LEFT 0711-06FS/EU/ 21 DOOR LT INT COLUMN	1.000	PCS																																																									
					0B1207A0	LEFT 0711-06FS/EU/ 21 DOOR RT EXT COLUMN	1.000	PCS																																																									
					0B1216A1	TRAVERS SUPERIEUR PORTE MM CT 2V	1.000	PCS																																																									
					0B1217A1	X_TRAVERS SUPERIEUR INT PORTE 750 S6 2V	1.000	PCS																																																									
					CE1052A1	CABLE DE LIAISON CONTROLE-U SB MM 750MM	1.000	PCS																																																									
					CE1053B0	CABLE ALIM BARRE LED MM MICROFIT 2P	1.000	PCS																																																									
					CE1285A0	FERRITE EMI ROUND MOD. 2643801502	1.000	PCS																																																									
					CE1290A0	BORNE FEMELLE EXTRACTIBLE CPF 5/4	1.000	PCS																																																									
					CE1310A1	POWER - CONTROL BOARD CONNECTING CABLE	1.000	PCS																																																									
					GN1525A0	O-RING INT DIAM 9,5 THK 1 NBR 70	1.000	PCS																																																									
					LP1020A0	BARRE ECLAIRAGE LED MM L400 E583	1.000	PCS																																																									
LP1026A0	EXTRUDE ECLAIRAGE NON LED MM L583	1.000	PCS																																																														

COMPOSANT			PIÈCE DE RECHANGE																																																																										
Code	Description	Image	Code	Description	Composants du kit																																																																								
VT1277A	VITRE EXT SER XEVC-0711-E		KDR1266A	PORTE EXTERNE 0711 GAUCHE	<table border="1"> <thead> <tr> <th>Code</th> <th>Description</th> <th>Qté</th> <th>UOM</th> </tr> </thead> <tbody> <tr> <td>MG1083A2</td> <td>POIGNEE COMPLETE M</td> <td>1.000</td> <td>PCS</td> </tr> <tr> <td>SL1170A1</td> <td>SILICONE ANTHRACITE S57 CARTOUCHE 310ml</td> <td>37.000</td> <td>ML</td> </tr> <tr> <td>VE1030A1</td> <td>AIMANT D=22,9mm POUR MICROPORTE</td> <td>1.000</td> <td>PCS</td> </tr> <tr> <td>VI1034A0</td> <td>STAINLESS STEEL WASHER 8,4x16x1</td> <td>1.000</td> <td>PCS</td> </tr> <tr> <td>VI1147A0</td> <td>VIS INOX 5X25</td> <td>16.000</td> <td>PCS</td> </tr> <tr> <td>VI1220A1</td> <td>VIS AUTOTARADE UX 4.2x12 TCB MARUTEX PRE</td> <td>23.000</td> <td>PCS</td> </tr> <tr> <td>VI1996A0</td> <td>VIS M5x35 TCEI ZN</td> <td>13.000</td> <td>PCS</td> </tr> <tr> <td>VM1630A1</td> <td>BOUCHON POUSSE-VITR E INTERNE</td> <td>1.000</td> <td>PCS</td> </tr> <tr> <td>VM1631A0</td> <td>BOUCHON POUSSE-VITR E INTERNE PLUS</td> <td>2.000</td> <td>PCS</td> </tr> <tr> <td>VM2260A1</td> <td>6 SERIES DOOR UPPER LEFT CAP</td> <td>1.000</td> <td>PCS</td> </tr> <tr> <td>VM2267A0</td> <td>GLISSEUR SYSTEME BLOCAGE VITRE INT.</td> <td>2.000</td> <td>PCS</td> </tr> <tr> <td>VM2268A0</td> <td>DOOR MAGNET COVER</td> <td>2.000</td> <td>PCS</td> </tr> <tr> <td>VM2269A0</td> <td>INTERNAL GLASS LOCKING SYSTEM CAP</td> <td>2.000</td> <td>PCS</td> </tr> <tr> <td>VM2274A0</td> <td>DOUILLE RAINUREE COURTE</td> <td>1.000</td> <td>PCS</td> </tr> <tr> <td>VM2275A0</td> <td>DOUILLE LISSE COURT</td> <td>1.000</td> <td>PCS</td> </tr> <tr> <td>VM2284A0</td> <td>750 SERIES DRIP PROFILE</td> <td>1.000</td> <td>PCS</td> </tr> <tr> <td>VM2305A0</td> <td>DOUILLE DE FIXATION BOUCHON PORTE MM</td> <td>14.000</td> <td>PCS</td> </tr> </tbody> </table>	Code	Description	Qté	UOM	MG1083A2	POIGNEE COMPLETE M	1.000	PCS	SL1170A1	SILICONE ANTHRACITE S57 CARTOUCHE 310ml	37.000	ML	VE1030A1	AIMANT D=22,9mm POUR MICROPORTE	1.000	PCS	VI1034A0	STAINLESS STEEL WASHER 8,4x16x1	1.000	PCS	VI1147A0	VIS INOX 5X25	16.000	PCS	VI1220A1	VIS AUTOTARADE UX 4.2x12 TCB MARUTEX PRE	23.000	PCS	VI1996A0	VIS M5x35 TCEI ZN	13.000	PCS	VM1630A1	BOUCHON POUSSE-VITR E INTERNE	1.000	PCS	VM1631A0	BOUCHON POUSSE-VITR E INTERNE PLUS	2.000	PCS	VM2260A1	6 SERIES DOOR UPPER LEFT CAP	1.000	PCS	VM2267A0	GLISSEUR SYSTEME BLOCAGE VITRE INT.	2.000	PCS	VM2268A0	DOOR MAGNET COVER	2.000	PCS	VM2269A0	INTERNAL GLASS LOCKING SYSTEM CAP	2.000	PCS	VM2274A0	DOUILLE RAINUREE COURTE	1.000	PCS	VM2275A0	DOUILLE LISSE COURT	1.000	PCS	VM2284A0	750 SERIES DRIP PROFILE	1.000	PCS	VM2305A0	DOUILLE DE FIXATION BOUCHON PORTE MM	14.000	PCS
Code	Description	Qté	UOM																																																																										
MG1083A2	POIGNEE COMPLETE M	1.000	PCS																																																																										
SL1170A1	SILICONE ANTHRACITE S57 CARTOUCHE 310ml	37.000	ML																																																																										
VE1030A1	AIMANT D=22,9mm POUR MICROPORTE	1.000	PCS																																																																										
VI1034A0	STAINLESS STEEL WASHER 8,4x16x1	1.000	PCS																																																																										
VI1147A0	VIS INOX 5X25	16.000	PCS																																																																										
VI1220A1	VIS AUTOTARADE UX 4.2x12 TCB MARUTEX PRE	23.000	PCS																																																																										
VI1996A0	VIS M5x35 TCEI ZN	13.000	PCS																																																																										
VM1630A1	BOUCHON POUSSE-VITR E INTERNE	1.000	PCS																																																																										
VM1631A0	BOUCHON POUSSE-VITR E INTERNE PLUS	2.000	PCS																																																																										
VM2260A1	6 SERIES DOOR UPPER LEFT CAP	1.000	PCS																																																																										
VM2267A0	GLISSEUR SYSTEME BLOCAGE VITRE INT.	2.000	PCS																																																																										
VM2268A0	DOOR MAGNET COVER	2.000	PCS																																																																										
VM2269A0	INTERNAL GLASS LOCKING SYSTEM CAP	2.000	PCS																																																																										
VM2274A0	DOUILLE RAINUREE COURTE	1.000	PCS																																																																										
VM2275A0	DOUILLE LISSE COURT	1.000	PCS																																																																										
VM2284A0	750 SERIES DRIP PROFILE	1.000	PCS																																																																										
VM2305A0	DOUILLE DE FIXATION BOUCHON PORTE MM	14.000	PCS																																																																										

COMPOSANT			PIÈCE DE RECHANGE																																																																									
Code	Description	Image	Code	Description	Composants du kit																																																																							
VT1277A	VITRE EXT SER XEVC-0711-E		KDR1266A	PORTE EXTERNE 0711 GAUCHE	<table border="1"> <thead> <tr> <th>Code</th> <th>Description</th> <th>Qté</th> <th>UOM</th> </tr> </thead> <tbody> <tr> <td>VM2312A0</td> <td>TUBE GAUCHE DECHARGE EGOUTTEMEN T MM</td> <td>1.000</td> <td>PCS</td> </tr> <tr> <td>VM2313A0</td> <td>MM DRIP TRAY RIGHT DRAIN PIPE</td> <td>1.000</td> <td>PCS</td> </tr> <tr> <td>VM2314A0</td> <td>MM DRIP PROFILE CAP</td> <td>1.000</td> <td>PCS</td> </tr> <tr> <td>VM2315A0</td> <td>MIND.Maps INTERNAL GLASS CAP SUPPORT</td> <td>1.000</td> <td>PCS</td> </tr> <tr> <td>VM2383A0</td> <td>CAPUCHON SUP DROIT PORTE MM GAUCHE</td> <td>1.000</td> <td>PCS</td> </tr> <tr> <td>VM2385A1</td> <td>LEFT MM DOOR UPPER LEFT CAP</td> <td>1.000</td> <td>PCS</td> </tr> <tr> <td>VM2386A1</td> <td>LEFT MM DOOR LOWER LEFT CAP</td> <td>1.000</td> <td>PCS</td> </tr> <tr> <td>VM2410A0</td> <td>PLAQUETTE ARRET EXTRUDE BARRE LED</td> <td>2.000</td> <td>PCS</td> </tr> <tr> <td>VM2505A0</td> <td>MM PLUS INTERNAL GLASS SUPPORT</td> <td>2.000</td> <td>PCS</td> </tr> <tr> <td>VM2518A0</td> <td>SUPP VENTILAT REFROID CONTROLE 20X20 H20</td> <td>1.000</td> <td>PCS</td> </tr> <tr> <td>VN1179A1</td> <td>VENTILO AXIAL 40X40X20MM 12VCD</td> <td>1.000</td> <td>PCS</td> </tr> <tr> <td>VT1277A0</td> <td>VITRE EXT SER XEVC-0711-E</td> <td>1.000</td> <td>PCS</td> </tr> </tbody> </table>	Code	Description	Qté	UOM	VM2312A0	TUBE GAUCHE DECHARGE EGOUTTEMEN T MM	1.000	PCS	VM2313A0	MM DRIP TRAY RIGHT DRAIN PIPE	1.000	PCS	VM2314A0	MM DRIP PROFILE CAP	1.000	PCS	VM2315A0	MIND.Maps INTERNAL GLASS CAP SUPPORT	1.000	PCS	VM2383A0	CAPUCHON SUP DROIT PORTE MM GAUCHE	1.000	PCS	VM2385A1	LEFT MM DOOR UPPER LEFT CAP	1.000	PCS	VM2386A1	LEFT MM DOOR LOWER LEFT CAP	1.000	PCS	VM2410A0	PLAQUETTE ARRET EXTRUDE BARRE LED	2.000	PCS	VM2505A0	MM PLUS INTERNAL GLASS SUPPORT	2.000	PCS	VM2518A0	SUPP VENTILAT REFROID CONTROLE 20X20 H20	1.000	PCS	VN1179A1	VENTILO AXIAL 40X40X20MM 12VCD	1.000	PCS	VT1277A0	VITRE EXT SER XEVC-0711-E	1.000	PCS	KDR1262B	PORTE EXTERNE 0711 -M DROITE	<table border="1"> <thead> <tr> <th>Code</th> <th>Description</th> <th>Qté</th> <th>UOM</th> </tr> </thead> <tbody> <tr> <td>0B1111A0</td> <td>XEVC-0711-E LEFT EXT DOOR COLUM</td> <td>1.000</td> <td>PCS</td> </tr> <tr> <td>0B1112A2</td> <td>0711 RIGHT - DOOR LEFT INT COLUMN</td> <td>1.000</td> <td>PCS</td> </tr> <tr> <td>0B1113B1</td> <td>COLONNE EXT DROITE PORTE XEVC-0711</td> <td>1.000</td> <td>PCS</td> </tr> </tbody> </table>	Code	Description	Qté	UOM	0B1111A0	XEVC-0711-E LEFT EXT DOOR COLUM	1.000	PCS	0B1112A2	0711 RIGHT - DOOR LEFT INT COLUMN	1.000	PCS	0B1113B1	COLONNE EXT DROITE PORTE XEVC-0711	1.000	PCS
			Code	Description	Qté	UOM																																																																						
VM2312A0	TUBE GAUCHE DECHARGE EGOUTTEMEN T MM	1.000	PCS																																																																									
VM2313A0	MM DRIP TRAY RIGHT DRAIN PIPE	1.000	PCS																																																																									
VM2314A0	MM DRIP PROFILE CAP	1.000	PCS																																																																									
VM2315A0	MIND.Maps INTERNAL GLASS CAP SUPPORT	1.000	PCS																																																																									
VM2383A0	CAPUCHON SUP DROIT PORTE MM GAUCHE	1.000	PCS																																																																									
VM2385A1	LEFT MM DOOR UPPER LEFT CAP	1.000	PCS																																																																									
VM2386A1	LEFT MM DOOR LOWER LEFT CAP	1.000	PCS																																																																									
VM2410A0	PLAQUETTE ARRET EXTRUDE BARRE LED	2.000	PCS																																																																									
VM2505A0	MM PLUS INTERNAL GLASS SUPPORT	2.000	PCS																																																																									
VM2518A0	SUPP VENTILAT REFROID CONTROLE 20X20 H20	1.000	PCS																																																																									
VN1179A1	VENTILO AXIAL 40X40X20MM 12VCD	1.000	PCS																																																																									
VT1277A0	VITRE EXT SER XEVC-0711-E	1.000	PCS																																																																									
Code	Description	Qté	UOM																																																																									
0B1111A0	XEVC-0711-E LEFT EXT DOOR COLUM	1.000	PCS																																																																									
0B1112A2	0711 RIGHT - DOOR LEFT INT COLUMN	1.000	PCS																																																																									
0B1113B1	COLONNE EXT DROITE PORTE XEVC-0711	1.000	PCS																																																																									

COMPOSANT			PIÈCE DE RECHANGE					
Code	Description	Image	Code	Description	Composants du kit			
VT1277A	VITRE EXT SER XEVC-0711-E		KDR1262B	PORTE EXTERNE 0711 -M DROITE	Code	Description	Qté	UOM
					0B1114A2	0711 RIGHT - DOOR RIGHT INT COLUMN	1.000	PCS
					0B1122B0	MM CT 750mm DOOR LOWER BEAM	1.000	PCS
					0B1167A0	PROFIL SUPPORT VITRE EXT XEVC-0711-E	2.000	PCS
					0B1216B0	MM DOUBLE GLASS DOOR 750mm UPPER BEAM	1.000	PCS
					0B1217A1	X_TRAVERS SUPERIEUR INT PORTE 750 S6 2V	1.000	PCS
					CE1052A1	CABLE DE LIAISON CONTROLE-U SB MM 750MM	1.000	PCS
					CE1053B0	CABLE ALIM BARRE LED MM MICROFIT 2P	1.000	PCS
					CE1097A0	CABLE BUS MICROFIT 4 POLES SIHF 4	1.000	PCS
					CE1285A0	FERRITE EMI ROUND MOD. 2643801502	2.000	PCS
					GN1525A0	O-RING INT DIAM 9,5 THK 1 NBR 70	1.000	PCS
					LP1020A0	BARRE ECLAIRAGE LED MM L400 E583	1.000	PCS
					LP1026A0	EXTRUDE ECLAIRAGE NON LED MM L583	1.000	PCS
					MG1099A1	POIGNEE COMPLETE MMc	1.000	PCS
					RC1200A0	RESSORT A COMPRESSIO N DE=4 DFIL=0.5	4.000	PCS
SL1170A1	SILICONE ANTHRACITE S57 CARTOUCHE 310ml	37.000	ML					



COMPOSANT			PIÈCE DE RECHANGE					
Code	Description	Image	Code	Description	Composants du kit			
VT1277A	VITRE EXT SER XEVC-0711-E		KDR1262B	PORTE EXTERNE 0711 -M DROITE	Code	Description	Qté	UOM
					SL1221A0	GN1/1 EXTERNAL GLASS UPPER SILICONE	1.000	PCS
					SL1224A0	0711 EXTERNAL GLASS LATERAL SILICONE	4.000	PCS
					VE1030A1	AIMANT D=22,9mm POUR MICROPORTE	1.000	PCS
					VI0239A1	VIS AUTOPERCEU SE 4.2X25 TCB+INOX	4.000	PCS
					VI1034A0	STAINLESS STEEL WASHER 8.4x16x1	1.000	PCS
					VI1074A0	VIS POUR PLASTIQUE 4X16 TCB+INO	2.000	PCS
					VI1103A0	VIS POUR PLASTIQUE 40X12 TPBS+INOX	2.000	PCS
					VI1220A1	VIS AUTOTARADE UX 4.2x12 TCB MARUTEX PRE	26.000	PCS
					VI1930A1	VIS 5X20 AGGLOMERE INOX	16.000	PCS
					VI1996A0	VIS M5x35 TCEI ZN	13.000	PCS
					VI2070A0	VIS 40X8 TCB+ SHEETTRACS	6.000	PCS
					VM1490A0	COUVERTURE VIS POIGNEE CT BT	2.000	PCS
					VM1630A1	BOUCHON POUSSE-VITR E INTERNE	3.000	PCS
					VM1631A0	BOUCHON POUSSE-VITR E INTERNE PLUS	3.000	PCS
					VM2259B0		1.000	PCS
					VM2260B0	S6 LEFT UPPER CAP	1.000	PCS
VM2261B0	MM -M DOOR RIGHT LOWER CAP	1.000	PCS					

COMPOSANT			PIÈCE DE RECHANGE					
Code	Description	Image	Code	Description	Composants du kit			
VT1277A	VITRE EXT SER XEVC-0711-E		KDR1262B	PORTE EXTERNE 0711 -M DROITE	Code	Description	Qté	UOM
					VM2262B0	MM -M DOOR RIGHT UPPER CAP	1.000	PCS
					VM2267A0	GLISSEUR SYSTEME BLOCAGE VITRE INT.	2.000	PCS
					VM2268A0	DOOR MAGNET COVER	2.000	PCS
					VM2269B0	INNER GLASS FIXING CAP	2.000	PCS
					VM2274A0	DOUILLE RAINUREE COURTE	1.000	PCS
					VM2275A0	DOUILLE LISSE COURT	1.000	PCS
					VM2284B0	KIT PROFIL GOUTTES SERIE 750	1.000	PCS
					VM2305A0	DOUILLE DE FIXATION BOUCHON PORTE MM	14.000	PCS
					VM2312A0	TUBE GAUCHE DECHARGE EGOUTTEMEN T MM	1.000	PCS
					VM2314A0	MM DRIP PROFILE CAP	1.000	PCS
					VM2315B0	MM - M INNER GLASS PUSHING CAP HOLDER	3.000	PCS
					VM2410A0	PLAQUETTE ARRET EXTRUDE BARRE LED	2.000	PCS
					VM2505B1	SUPPORT PUSSE-VITRE INTERNE MM PLUS	3.000	PCS
					VP1080A0	BOUCHON SUP CHARNIERE VITRE INTER INF	1.000	PCS
					VP1081A0	BOUCHON SUP CHARNIERE VITRE INT SUP	1.000	PCS
					VT1277A0	VITRE EXT SER XEVC-0711-E	1.000	PCS

COMPOSANT			PIÈCE DE RECHANGE					
Code	Description	Image	Code	Description	Composants du kit			
VT1277A	VITRE EXT SER XEVC-0711-E		KDR1262A	PORTE EXTERNE 0711 DROITE	Code	Description	Qté	UOM
					0B1111A0	XEVC-0711-E LEFT EXT DOOR COLUMN	1.000	PCS
					0B1112A2	0711 RIGHT - DOOR LEFT INT COLUMN	1.000	PCS
					0B1113B1	COLONNE EXT DROITE PORTE XEVC-0711	1.000	PCS
					0B1114A2	0711 RIGHT - DOOR RIGHT INT COLUMN	1.000	PCS
					0B1122A1	750MM DOOR LOWER FRAME SHAPE	1.000	PCS
					0B1167A0	PROFIL SUPPORT VITRE EXT XEVC-0711-E	2.000	PCS
					0B1216A1	TRAVERS SUPERIEUR PORTE MM CT 2V	1.000	PCS
					0B1217A1	X_TRAVERS SUPERIEUR INT PORTE 750 S6 2V	1.000	PCS
					CE1052A1	CABLE DE LIAISON CONTROLE-U SB MM 750MM	1.000	PCS
					CE1053B0	CABLE ALIM BARRE LED MM MICROFIT 2P	1.000	PCS
					CE1285A0	FERRITE EMI ROUND MOD. 2643801502	1.000	PCS
					CE1290A0	BORNE FEMELLE EXTRACTIBLE CPF 5/4	1.000	PCS
					CE1310A1	POWER - CONTROL BOARD CONNECTING CABLE	1.000	PCS
					GN1525A0	O-RING INT DIAM 9,5 THK 1 NBR 70	1.000	PCS
LP1020A0	BARRE ECLAIRAGE LED MM L400 E583	1.000	PCS					

COMPOSANT			PIÈCE DE RECHANGE																																																																						
Code	Description	Image	Code	Description	Composants du kit																																																																				
VT1277A	VITRE EXT SER XEVC-0711-E		KDR1262A	PORTE EXTERNE 0711 DROITE	<table border="1"> <thead> <tr> <th>Code</th> <th>Description</th> <th>Qté</th> <th>UOM</th> </tr> </thead> <tbody> <tr> <td>LP1026A0</td> <td>EXTRUDE ECLAIRAGE NON LED MM L583</td> <td>1.000</td> <td>PCS</td> </tr> <tr> <td>MG1083A2</td> <td>POIGNEE COMPLETE M</td> <td>1.000</td> <td>PCS</td> </tr> <tr> <td>SL1170A1</td> <td>SILICONE ANTHRACITE S57 CARTOUCHE 310ml</td> <td>11.000</td> <td>ML</td> </tr> <tr> <td>VE1030A1</td> <td>AIMANT D=22,9mm POUR MICROPORTE</td> <td>1.000</td> <td>PCS</td> </tr> <tr> <td>VI1034A0</td> <td>STAINLESS STEEL WASHER 8,4x16x1</td> <td>1.000</td> <td>PCS</td> </tr> <tr> <td>VI1147A0</td> <td>VIS INOX 5X25</td> <td>16.000</td> <td>PCS</td> </tr> <tr> <td>VI1220A1</td> <td>VIS AUTOTARADE UX 4,2x12 TCB MARUTEX PRE</td> <td>23.000</td> <td>PCS</td> </tr> <tr> <td>VI1996A0</td> <td>VIS M5x35 TCEI ZN</td> <td>13.000</td> <td>PCS</td> </tr> <tr> <td>VM1630A1</td> <td>BOUCHON POUSSE-VITR E INTERNE</td> <td>1.000</td> <td>PCS</td> </tr> <tr> <td>VM1631A0</td> <td>BOUCHON POUSSE-VITR E INTERNE PLUS</td> <td>2.000</td> <td>PCS</td> </tr> <tr> <td>VM2259A1</td> <td>6 SERIES DOOR LOWER LEFT CAP</td> <td>1.000</td> <td>PCS</td> </tr> <tr> <td>VM2260A1</td> <td>6 SERIES DOOR UPPER LEFT CAP</td> <td>1.000</td> <td>PCS</td> </tr> <tr> <td>VM2262A1</td> <td>MM DOOR UPPER RIGHT CAP</td> <td>1.000</td> <td>PCS</td> </tr> <tr> <td>VM2267A0</td> <td>GLISSEUR SYSTEME BLOCAGE VITRE INT.</td> <td>2.000</td> <td>PCS</td> </tr> <tr> <td>VM2268A0</td> <td>DOOR MAGNET COVER</td> <td>2.000</td> <td>PCS</td> </tr> <tr> <td>VM2269A0</td> <td>INTERNAL GLASS LOCKING SYSTEM CAP</td> <td>2.000</td> <td>PCS</td> </tr> </tbody> </table>	Code	Description	Qté	UOM	LP1026A0	EXTRUDE ECLAIRAGE NON LED MM L583	1.000	PCS	MG1083A2	POIGNEE COMPLETE M	1.000	PCS	SL1170A1	SILICONE ANTHRACITE S57 CARTOUCHE 310ml	11.000	ML	VE1030A1	AIMANT D=22,9mm POUR MICROPORTE	1.000	PCS	VI1034A0	STAINLESS STEEL WASHER 8,4x16x1	1.000	PCS	VI1147A0	VIS INOX 5X25	16.000	PCS	VI1220A1	VIS AUTOTARADE UX 4,2x12 TCB MARUTEX PRE	23.000	PCS	VI1996A0	VIS M5x35 TCEI ZN	13.000	PCS	VM1630A1	BOUCHON POUSSE-VITR E INTERNE	1.000	PCS	VM1631A0	BOUCHON POUSSE-VITR E INTERNE PLUS	2.000	PCS	VM2259A1	6 SERIES DOOR LOWER LEFT CAP	1.000	PCS	VM2260A1	6 SERIES DOOR UPPER LEFT CAP	1.000	PCS	VM2262A1	MM DOOR UPPER RIGHT CAP	1.000	PCS	VM2267A0	GLISSEUR SYSTEME BLOCAGE VITRE INT.	2.000	PCS	VM2268A0	DOOR MAGNET COVER	2.000	PCS	VM2269A0	INTERNAL GLASS LOCKING SYSTEM CAP	2.000	PCS
					Code	Description	Qté	UOM																																																																	
					LP1026A0	EXTRUDE ECLAIRAGE NON LED MM L583	1.000	PCS																																																																	
					MG1083A2	POIGNEE COMPLETE M	1.000	PCS																																																																	
					SL1170A1	SILICONE ANTHRACITE S57 CARTOUCHE 310ml	11.000	ML																																																																	
					VE1030A1	AIMANT D=22,9mm POUR MICROPORTE	1.000	PCS																																																																	
					VI1034A0	STAINLESS STEEL WASHER 8,4x16x1	1.000	PCS																																																																	
					VI1147A0	VIS INOX 5X25	16.000	PCS																																																																	
					VI1220A1	VIS AUTOTARADE UX 4,2x12 TCB MARUTEX PRE	23.000	PCS																																																																	
					VI1996A0	VIS M5x35 TCEI ZN	13.000	PCS																																																																	
					VM1630A1	BOUCHON POUSSE-VITR E INTERNE	1.000	PCS																																																																	
					VM1631A0	BOUCHON POUSSE-VITR E INTERNE PLUS	2.000	PCS																																																																	
					VM2259A1	6 SERIES DOOR LOWER LEFT CAP	1.000	PCS																																																																	
					VM2260A1	6 SERIES DOOR UPPER LEFT CAP	1.000	PCS																																																																	
					VM2262A1	MM DOOR UPPER RIGHT CAP	1.000	PCS																																																																	
					VM2267A0	GLISSEUR SYSTEME BLOCAGE VITRE INT.	2.000	PCS																																																																	
					VM2268A0	DOOR MAGNET COVER	2.000	PCS																																																																	
VM2269A0	INTERNAL GLASS LOCKING SYSTEM CAP	2.000	PCS																																																																						

COMPOSANT			PIÈCE DE RECHANGE																																																										
Code	Description	Image	Code	Description	Composants du kit																																																								
VT1277A	VITRE EXT SER XEVC-0711-E		KDR1262A	PORTE EXTERNE 0711 DROITE	<table border="1"> <thead> <tr> <th>Code</th> <th>Description</th> <th>Qté</th> <th>UOM</th> </tr> </thead> <tbody> <tr> <td>VM2274A0</td> <td>DOUILLE RAINUREE COURTE</td> <td>1.000</td> <td>PCS</td> </tr> <tr> <td>VM2275A0</td> <td>DOUILLE LISSE COURT</td> <td>1.000</td> <td>PCS</td> </tr> <tr> <td>VM2284A0</td> <td>750 SERIES DRIP PROFILE</td> <td>1.000</td> <td>PCS</td> </tr> <tr> <td>VM2305A0</td> <td>DOUILLE DE FIXATION BOUCHON PORTE MM</td> <td>14.000</td> <td>PCS</td> </tr> <tr> <td>VM2312A0</td> <td>TUBE GAUCHE DECHARGE EGOUTTEMEN T MM</td> <td>1.000</td> <td>PCS</td> </tr> <tr> <td>VM2313A0</td> <td>MM DRIP TRAY RIGHT DRAIN PIPE</td> <td>1.000</td> <td>PCS</td> </tr> <tr> <td>VM2314A0</td> <td>MM DRIP PROFILE CAP</td> <td>1.000</td> <td>PCS</td> </tr> <tr> <td>VM2315A0</td> <td>MIND.Maps INTERNAL GLASS CAP SUPPORT</td> <td>1.000</td> <td>PCS</td> </tr> <tr> <td>VM2410A0</td> <td>PLAQUETTE ARRET EXTRUDE BARRE LED</td> <td>2.000</td> <td>PCS</td> </tr> <tr> <td>VM2505A0</td> <td>MM PLUS INTERNAL GLASS SUPPORT</td> <td>2.000</td> <td>PCS</td> </tr> <tr> <td>VM2518A0</td> <td>SUPP VENTILAT REFROID CONTROLE 20X20 H20</td> <td>1.000</td> <td>PCS</td> </tr> <tr> <td>VN1179A1</td> <td>VENTILO AXIAL 40X40X20MM 12VCD</td> <td>1.000</td> <td>PCS</td> </tr> <tr> <td>VT1277A0</td> <td>VITRE EXT SER XEVC-0711-E</td> <td>1.000</td> <td>PCS</td> </tr> </tbody> </table>	Code	Description	Qté	UOM	VM2274A0	DOUILLE RAINUREE COURTE	1.000	PCS	VM2275A0	DOUILLE LISSE COURT	1.000	PCS	VM2284A0	750 SERIES DRIP PROFILE	1.000	PCS	VM2305A0	DOUILLE DE FIXATION BOUCHON PORTE MM	14.000	PCS	VM2312A0	TUBE GAUCHE DECHARGE EGOUTTEMEN T MM	1.000	PCS	VM2313A0	MM DRIP TRAY RIGHT DRAIN PIPE	1.000	PCS	VM2314A0	MM DRIP PROFILE CAP	1.000	PCS	VM2315A0	MIND.Maps INTERNAL GLASS CAP SUPPORT	1.000	PCS	VM2410A0	PLAQUETTE ARRET EXTRUDE BARRE LED	2.000	PCS	VM2505A0	MM PLUS INTERNAL GLASS SUPPORT	2.000	PCS	VM2518A0	SUPP VENTILAT REFROID CONTROLE 20X20 H20	1.000	PCS	VN1179A1	VENTILO AXIAL 40X40X20MM 12VCD	1.000	PCS	VT1277A0	VITRE EXT SER XEVC-0711-E	1.000	PCS
					Code	Description	Qté	UOM																																																					
					VM2274A0	DOUILLE RAINUREE COURTE	1.000	PCS																																																					
					VM2275A0	DOUILLE LISSE COURT	1.000	PCS																																																					
					VM2284A0	750 SERIES DRIP PROFILE	1.000	PCS																																																					
					VM2305A0	DOUILLE DE FIXATION BOUCHON PORTE MM	14.000	PCS																																																					
					VM2312A0	TUBE GAUCHE DECHARGE EGOUTTEMEN T MM	1.000	PCS																																																					
					VM2313A0	MM DRIP TRAY RIGHT DRAIN PIPE	1.000	PCS																																																					
					VM2314A0	MM DRIP PROFILE CAP	1.000	PCS																																																					
					VM2315A0	MIND.Maps INTERNAL GLASS CAP SUPPORT	1.000	PCS																																																					
					VM2410A0	PLAQUETTE ARRET EXTRUDE BARRE LED	2.000	PCS																																																					
					VM2505A0	MM PLUS INTERNAL GLASS SUPPORT	2.000	PCS																																																					
					VM2518A0	SUPP VENTILAT REFROID CONTROLE 20X20 H20	1.000	PCS																																																					
					VN1179A1	VENTILO AXIAL 40X40X20MM 12VCD	1.000	PCS																																																					
					VT1277A0	VITRE EXT SER XEVC-0711-E	1.000	PCS																																																					

ASM2926A/0.D02 - Système électrique - FACE AVANT

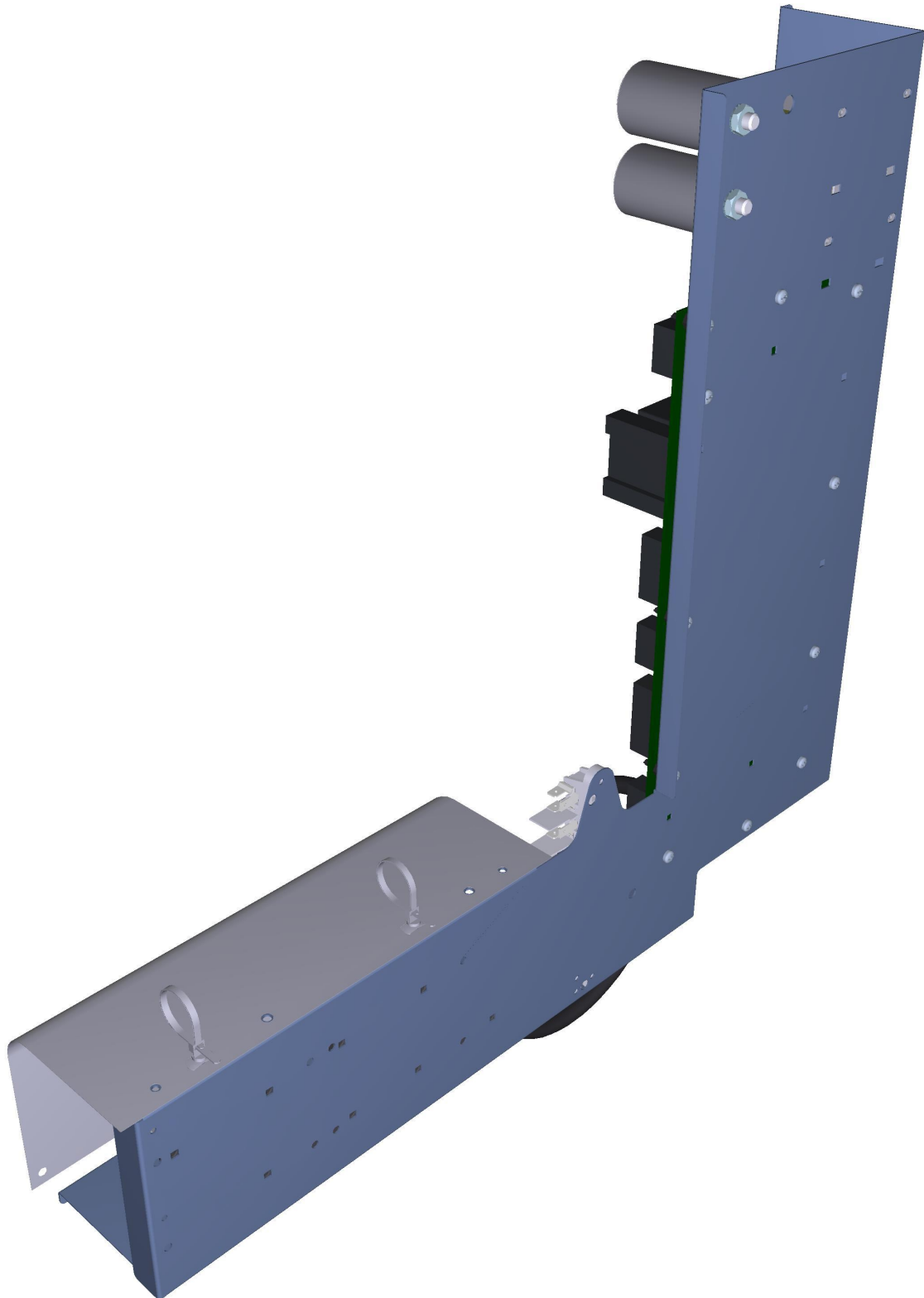

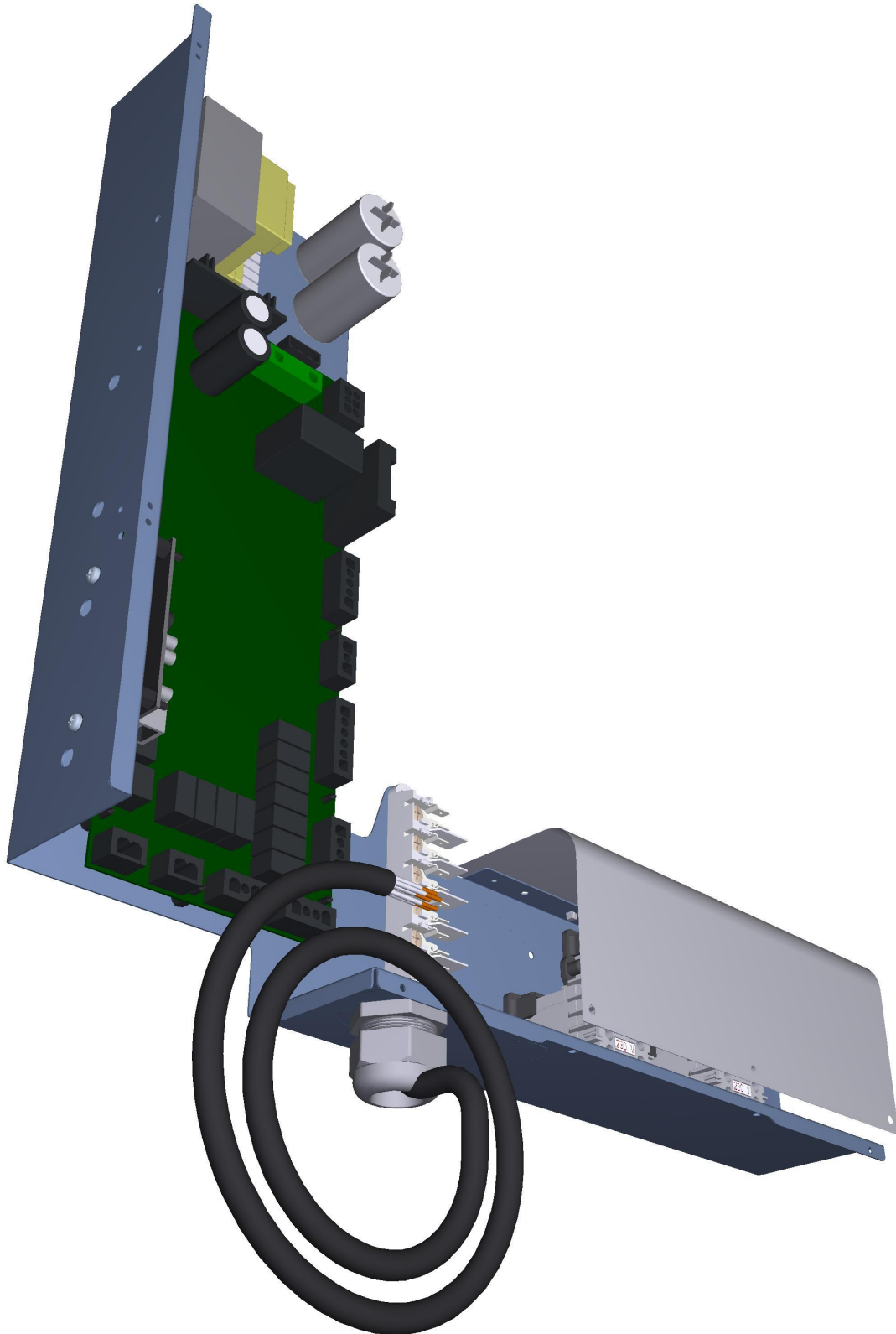

ASM2926A/0.D02 - Système électrique - ARRIÈRE

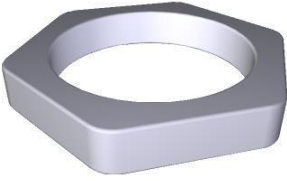

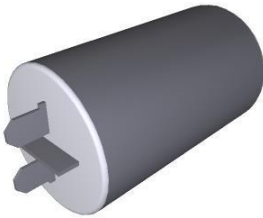
COMPOSANT			PIÈCE DE RECHANGE														
Code	Description	Image	Code	Description	Composants du kit												
0H7250A	PROFIL PORTE COMPOSANTS MM GN1/1		0H7250A0	PROFIL PORTE COMPOSANTS MM GN1/1													
VE1115A	MINICONTACTEUR A 4 POLES 20 A 230V		KVE1115A	KIT MINICONTACTEUR QUADRIPOL 20A 230	<table border="1"> <thead> <tr> <th>Code</th> <th>Description</th> <th>Qté</th> <th>UOM</th> </tr> </thead> <tbody> <tr> <td>VE1115A0</td> <td>MINICONTACTEUR A 4 POLES 20 A 230V</td> <td>1.000</td> <td>PCS</td> </tr> <tr> <td>VM1075A1</td> <td>CLIP EN PLASTIQUE POUR FIXER LES TÉLÉRUP</td> <td>4.000</td> <td>PCS</td> </tr> </tbody> </table>	Code	Description	Qté	UOM	VE1115A0	MINICONTACTEUR A 4 POLES 20 A 230V	1.000	PCS	VM1075A1	CLIP EN PLASTIQUE POUR FIXER LES TÉLÉRUP	4.000	PCS
Code	Description	Qté	UOM														
VE1115A0	MINICONTACTEUR A 4 POLES 20 A 230V	1.000	PCS														
VM1075A1	CLIP EN PLASTIQUE POUR FIXER LES TÉLÉRUP	4.000	PCS														
VM1056A	ETRIER TELERUPTEUR PETIT VE1115A		VM1056A0	ETRIER TELERUPTEUR PETIT VE1115A													
VE1644A	ECROU PRESSE-CABLE PG 29		KVE1645A	KIT PRESSE-ETOUPE PG29 REDUIT+ECROU	<table border="1"> <thead> <tr> <th>Code</th> <th>Description</th> <th>Qté</th> <th>UOM</th> </tr> </thead> <tbody> <tr> <td>VE1644A0</td> <td>ECROU PRESSE-CABLE PG 29</td> <td>1.000</td> <td>PCS</td> </tr> <tr> <td>VE1645A1</td> <td>PRESSE-CABLE PG 29 REDUIT</td> <td>1.000</td> <td>PCS</td> </tr> </tbody> </table>	Code	Description	Qté	UOM	VE1644A0	ECROU PRESSE-CABLE PG 29	1.000	PCS	VE1645A1	PRESSE-CABLE PG 29 REDUIT	1.000	PCS
Code	Description	Qté	UOM														
VE1644A0	ECROU PRESSE-CABLE PG 29	1.000	PCS														
VE1645A1	PRESSE-CABLE PG 29 REDUIT	1.000	PCS														
VE1645A	PRESSE-CABLE PG 29 REDUIT		KVE1645A	KIT PRESSE-ETOUPE PG29 REDUIT+ECROU	<table border="1"> <thead> <tr> <th>Code</th> <th>Description</th> <th>Qté</th> <th>UOM</th> </tr> </thead> <tbody> <tr> <td>VE1644A0</td> <td>ECROU PRESSE-CABLE PG 29</td> <td>1.000</td> <td>PCS</td> </tr> <tr> <td>VE1645A1</td> <td>PRESSE-CABLE PG 29 REDUIT</td> <td>1.000</td> <td>PCS</td> </tr> </tbody> </table>	Code	Description	Qté	UOM	VE1644A0	ECROU PRESSE-CABLE PG 29	1.000	PCS	VE1645A1	PRESSE-CABLE PG 29 REDUIT	1.000	PCS
Code	Description	Qté	UOM														
VE1644A0	ECROU PRESSE-CABLE PG 29	1.000	PCS														
VE1645A1	PRESSE-CABLE PG 29 REDUIT	1.000	PCS														

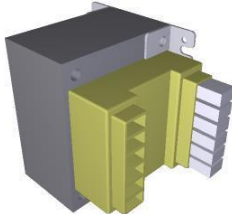
COMPOSANT			PIÈCE DE RECHANGE																																		
Code	Description	Image	Code	Description	Composants du kit																																
PE2052A	PONT MM POUR CONNEXION LAN		XEC001	UNOX.Link CONNECTION ETHERNET ONE/PLUS	<table border="1"> <thead> <tr> <th>Code</th> <th>Description</th> <th>Qté</th> <th>UOM</th> </tr> </thead> <tbody> <tr> <td>0H7386B0</td> <td>SUPPORT CARTE SONDE SOUS VIDE</td> <td>1.000</td> <td>PCS</td> </tr> <tr> <td>0H7451A0</td> <td>TOLE SUPPORT LAN</td> <td>1.000</td> <td>PCS</td> </tr> <tr> <td>CE1065A0</td> <td>CABLE 4x0.5 MICROFIT 4P-500MM-MIC ROFIT4P</td> <td>1.000</td> <td>PCS</td> </tr> <tr> <td>PE2157A0</td> <td></td> <td>1.000</td> <td>PCS</td> </tr> <tr> <td>VI1220A1</td> <td>VIS AUTOTARADE UX 4.2x12 TCB MARUTEX PRE</td> <td>2.000</td> <td>PCS</td> </tr> <tr> <td>VI1850A0</td> <td>VIS M4X6 TCB+ EN NICKEL</td> <td>6.000</td> <td>PCS</td> </tr> <tr> <td>VM1745A0</td> <td>SUPPORT POUR CARTE</td> <td>4.000</td> <td>PCS</td> </tr> </tbody> </table>	Code	Description	Qté	UOM	0H7386B0	SUPPORT CARTE SONDE SOUS VIDE	1.000	PCS	0H7451A0	TOLE SUPPORT LAN	1.000	PCS	CE1065A0	CABLE 4x0.5 MICROFIT 4P-500MM-MIC ROFIT4P	1.000	PCS	PE2157A0		1.000	PCS	VI1220A1	VIS AUTOTARADE UX 4.2x12 TCB MARUTEX PRE	2.000	PCS	VI1850A0	VIS M4X6 TCB+ EN NICKEL	6.000	PCS	VM1745A0	SUPPORT POUR CARTE	4.000	PCS
Code	Description	Qté	UOM																																		
0H7386B0	SUPPORT CARTE SONDE SOUS VIDE	1.000	PCS																																		
0H7451A0	TOLE SUPPORT LAN	1.000	PCS																																		
CE1065A0	CABLE 4x0.5 MICROFIT 4P-500MM-MIC ROFIT4P	1.000	PCS																																		
PE2157A0		1.000	PCS																																		
VI1220A1	VIS AUTOTARADE UX 4.2x12 TCB MARUTEX PRE	2.000	PCS																																		
VI1850A0	VIS M4X6 TCB+ EN NICKEL	6.000	PCS																																		
VM1745A0	SUPPORT POUR CARTE	4.000	PCS																																		
PE2038A	CARTE PUISSANCE MIND.Maps PLUS		KPE2038A	KIT CARTE PUISSANCE MIND.Maps PLUS	<table border="1"> <thead> <tr> <th>Code</th> <th>Description</th> <th>Qté</th> <th>UOM</th> </tr> </thead> <tbody> <tr> <td>PE2038A0</td> <td>CARTE PUISSANCE MIND.Maps PLUS</td> <td>1.000</td> <td>PCS</td> </tr> <tr> <td>VI1850A0</td> <td>VIS M4X6 TCB+ EN NICKEL</td> <td>12.000</td> <td>PCS</td> </tr> <tr> <td>VM1745A0</td> <td>SUPPORT POUR CARTE</td> <td>12.000</td> <td>PCS</td> </tr> </tbody> </table>	Code	Description	Qté	UOM	PE2038A0	CARTE PUISSANCE MIND.Maps PLUS	1.000	PCS	VI1850A0	VIS M4X6 TCB+ EN NICKEL	12.000	PCS	VM1745A0	SUPPORT POUR CARTE	12.000	PCS																
Code	Description	Qté	UOM																																		
PE2038A0	CARTE PUISSANCE MIND.Maps PLUS	1.000	PCS																																		
VI1850A0	VIS M4X6 TCB+ EN NICKEL	12.000	PCS																																		
VM1745A0	SUPPORT POUR CARTE	12.000	PCS																																		
CE1355A	CABLE 5X2,5MMQ H07RN-F L=1,5MT		KCE1355A	KIT CABLE 5X2.5 MMQ L1.5MT CE1355A1	<table border="1"> <thead> <tr> <th>Code</th> <th>Description</th> <th>Qté</th> <th>UOM</th> </tr> </thead> <tbody> <tr> <td>CE1355A1</td> <td>CABLE 5X2,5MMQ H07RN-F L=1,5MT</td> <td>1.000</td> <td>PCS</td> </tr> </tbody> </table>	Code	Description	Qté	UOM	CE1355A1	CABLE 5X2,5MMQ H07RN-F L=1,5MT	1.000	PCS																								
Code	Description	Qté	UOM																																		
CE1355A1	CABLE 5X2,5MMQ H07RN-F L=1,5MT	1.000	PCS																																		
CN1003A	CONDENSEUR 6,3 u		KCN1003A	KIT CONDENSATEUR MOTEUR 6,3 uF	<table border="1"> <thead> <tr> <th>Code</th> <th>Description</th> <th>Qté</th> <th>UOM</th> </tr> </thead> <tbody> <tr> <td>CN1003A0</td> <td>CONDENSEUR 6,3 uF</td> <td>1.000</td> <td>PCS</td> </tr> <tr> <td>VI1931A0</td> <td>ECROU M8x1,65 H4 CH13 ZINGUE</td> <td>1.000</td> <td>PCS</td> </tr> <tr> <td>VI1932A0</td> <td>RONDELLE DENTELEE D8 ZINGUEE</td> <td>1.000</td> <td>PCS</td> </tr> </tbody> </table>	Code	Description	Qté	UOM	CN1003A0	CONDENSEUR 6,3 uF	1.000	PCS	VI1931A0	ECROU M8x1,65 H4 CH13 ZINGUE	1.000	PCS	VI1932A0	RONDELLE DENTELEE D8 ZINGUEE	1.000	PCS																
Code	Description	Qté	UOM																																		
CN1003A0	CONDENSEUR 6,3 uF	1.000	PCS																																		
VI1931A0	ECROU M8x1,65 H4 CH13 ZINGUE	1.000	PCS																																		
VI1932A0	RONDELLE DENTELEE D8 ZINGUEE	1.000	PCS																																		

COMPOSANT			PIÈCE DE RECHANGE														
Code	Description	Image	Code	Description	Composants du kit												
MR1004A	BORNIER 7 BROCHES 41A 450V		KMR1004A	KIT BORNIER 7 POLES	<table border="1"> <thead> <tr> <th>Code</th> <th>Description</th> <th>Qté</th> <th>UOM</th> </tr> </thead> <tbody> <tr> <td>MR1004A1</td> <td>BORNIER 7 BROCHES 41A 450V</td> <td>1.000</td> <td>PCS</td> </tr> </tbody> </table>	Code	Description	Qté	UOM	MR1004A1	BORNIER 7 BROCHES 41A 450V	1.000	PCS				
Code	Description	Qté	UOM														
MR1004A1	BORNIER 7 BROCHES 41A 450V	1.000	PCS														
VE1026A	TRANSFORMATEUR 230-21-12Vac 90VA		KVE1026A	KIT TRANSFORMATEUR 230-21 12vac 90VA	<table border="1"> <thead> <tr> <th>Code</th> <th>Description</th> <th>Qté</th> <th>UOM</th> </tr> </thead> <tbody> <tr> <td>VE1026A0</td> <td>TRANSFORMA TEUR 230-21-12Vac 90VA</td> <td>1.000</td> <td>PCS</td> </tr> <tr> <td>VI1950A0</td> <td>VIS AUTOPERCEU SE 4.2X13 TCB INOX</td> <td>4.000</td> <td>PCS</td> </tr> </tbody> </table>	Code	Description	Qté	UOM	VE1026A0	TRANSFORMA TEUR 230-21-12Vac 90VA	1.000	PCS	VI1950A0	VIS AUTOPERCEU SE 4.2X13 TCB INOX	4.000	PCS
Code	Description	Qté	UOM														
VE1026A0	TRANSFORMA TEUR 230-21-12Vac 90VA	1.000	PCS														
VI1950A0	VIS AUTOPERCEU SE 4.2X13 TCB INOX	4.000	PCS														
VM2387A	PROTECTION TELERUPTEURS MM		VM2387A0	PROTECTION TELERUPTEURS MM													